

**GHIDINI**

# Indice generale

Storia	6	8. ACCIAIO INOX	434
Produzione	10	Maniglie + dk	438
Sostenibilità	14	Accessori	442
1. MANIGLIE E COORDINATI PER PORTE E FINESTRE	18	Maniglioni fissi	443
Alluminio galattico	26	9. NYLON	446
Zama	36	Maniglie + cremonesi	452
Ottone	116	Accessori	462
Alluminio	168	Maniglioni fissi	464
2. SERRAMENTI	226	Pomoli	465
DK / Cremonesi / Balcony door	228	Appendiabiti	466
Maniglioni per alzanti scorrevoli	308	Copri avvolgibili	467
3. ACCESSORI PER PORTE E FINESTRE	316	10. COORDINATI E COMPLEMENTI D'ARREDO	468
Rosette ottone	318	Ganci rigidi	470
Nottolini ottone	326	Cricchetti	470
Rosette e placche alluminio	329	Pinze fermaporte	471
Giochi DK	342	Copri avvolgibili	471
Ferri	343	Fermaporte	472
Viti	346	Supporti	473
4. COORDINATI PER PORTE SCORREVOLI	348	Piedini	474
Alluminio galattico	350	Manigliette ponte	475
Zama	352	11. ACCESSORI PER INFISSI ESTERNI	476
Ottone	359	Arsenio	478
Alluminio	361	Ometti	479
5. ALLUMINIO GALATTICO	366	12. METALMEC	486
Maniglie + dk	368	13. ESPOSITORI	492
Maniglioni per alzanti scorrevoli	374	14. APPROFONDIMENTI	498
Maniglie per porte scorrevoli	375	Riepilogo finiture	500
Maniglioni fissi	377	Resistenza alla corrosione	501
6. ARTICOLI SMART	378	Ghi.co.tec	502
Maniglie + dk	380	G-Plus	504
Maniglie per porte scorrevoli	403	Avvertenze	506
7. PORTE D'INGRESSO	406	Condizioni Generali di Vendita	508
Pomoli	408	Contatti	514
Maniglioni fissi	415		
Battenti	420		
Rosette - bocchette - placche per porte blindate	422		
Maniglie singole	428		
Nottolini limitatori d'apertura per porte blindate	430		
Kit per porte basculanti	433		

# General index

History	6	8. STAINLESS STEEL	434
Production	10	Handles + dk	438
Sustainability	14	Accessories	442
		Pull handles	443
1. DOOR HANDLES AND DOOR AND WINDOW ACCESSORIES	18		
Galactic Aluminum	26	NYLON	446
Zamak	36	Handles	452
Brass	116	Accessories	462
Aluminum	168	Pull handles	464
		Knobs	465
2. WINDOWS	226	Coat hangers	466
DK / Window handles / Balcony door	228	Plates for roller shutters	467
Pull handle for sliding door	308		
3. ACCESSORIES FOR DOORS AND WINDOWS	316	10. ACCESSORIES AND FURNITURE FITTINGS	468
Brass roses	318	Door hooks	470
Brass knobs	326	Ratchet windows	470
Aluminum roses and plates	329	Door stopper clamp	471
DK mechanism	342	Plates for roller shutters	471
Spindles	343	Doorstop	472
Screws	346	Handrail supports	473
		Brass adjusting screw	474
4. SLIDING DOOR ACCESSORIES	348	Bridge handles	475
Galactic Aluminum	350		
Zamak	352	11. WINDOWS ACCESSORIES EQUIPMENT	476
Brass	359	Arsenio	478
Aluminum	361	Ometti	479
5. GALACTIC ALUMINUM	366	12. METALMEC	486
Handles + dk	368		
Pull handle for sliding door	374	13. DISPLAY UNITS	492
Sliding door handles	375		
Pull handles	377	14.IN_DEPTH STUDY	498
		Finishing summary	500
6. SMART PRODUCTS	378	Corrosion resistance	501
Handles + dk	380	Ghi.co.tec	502
Sliding door handles	403	G-Plus	504
		Warnings	506
7. ENTRANCE DOORS	406	General Terms and Conditions of Sales	508
Knobs	408	Contact	514
Pull handles	415		
Door knockers	420		
Accessories	422		
Single handles	428		
Knobs for opening limiting device armored doors	430		
Garage door handle kit	433		

Dal 1929 GHIDINI PIETRO BOSCO rappresenta una lunga storia di maniglie e coordinati.

Lo sviluppo dell'azienda si inserisce nell'operosa tradizione artigianale ed industriale che caratterizza la Val Trompia situata a nord del capoluogo Brescia nell'Italia settentrionale.

Il soprannome "BOSCO" indicava la località nei pressi della cascina di proprietà di Pietro Ghidini e fu attribuito alla famiglia per distinguerla dai numerosi ceppi omonimi della zona.

Nel 1951 ebbe inizio la specializzazione nella produzione di maniglie che fino ad allora era affiancata alla produzione di posate.

Alla fine degli anni '60 venne edificato lo stabilimento che rappresenta tuttora la sede: da evidenziare l'idea lungimirante di individuare un'area alla confluenza tra due corsi d'acqua che consentirono la realizzazione di un bacino idroelettrico per l'autoproduzione di una parte dell'energia impiegata nei processi produttivi.

Negli anni il costante processo di innovazione tecnologica non si è mai arrestato.

Da ricordare l'operazione che nel 2004 ha portato all'acquisizione di un'azienda specializzata nella produzione di maniglie in alluminio anodizzato che ha dato origine alla divisione denominata GHIDINI ALUMINIUM.

Oggi GHIDINI rappresenta sicuramente un valido riferimento per il settore proponendo un catalogo di soluzioni tecniche e formali per maniglie e coordinati in ottone, lega di zinco (ZAMA), alluminio a cui si affiancano proposte in acciaio inox, nylon e ferro.



# History

Since 1929 GHIDINI PIETRO BOSCO has represented a long history of handles and coordinated products.

The company's development is part of the industrious artisan and industrial tradition that characterizes Val Trompia, located north of the capital Brescia in northern Italy.

The nickname "BOSCO" indicated the location near the farmhouse owned by Pietro Ghidini and was attributed to the family to distinguish it from the numerous homonymous lineages in the area.

In 1951, the specialization in the production of handles began, which until then had been accompanied by the production of cutlery.

At the end of the 1960s, the factory that is still the headquarters today was built: it is worth highlighting the far-sighted idea of identifying an area at the confluence of two waterways that allowed the creation of a hydroelectric basin for the self-production of part of the energy used in the production processes.

Over the years, the constant process of technological innovation has never stopped.

Worthy of mention is the operation that in 2004 led to the acquisition of a company specialized in the production of anodized aluminum handles, which gave rise to the division called GHIDINI ALUMINIUM.

Today GHIDINI certainly represents a valid reference for the sector by offering a catalogue of technical and formal solutions for handles and coordinated items in brass, zinc alloy (ZAMA), aluminium alongside proposals in stainless steel, nylon and iron.



14

**Tipo "ELEOANT,"**  
 Attacco infestato con guida

mm. 90	gr. 330
" 95	" 370
" 100	" 390
" 110	" 550
" 130	" 900
" 125	" 800

**MANIGLIE per Serrature da Cancello con rosette**  
 mm. 120 gr. 350 circa

**Maniglie Tipo MANICO OMBRELLO PERLINATE**  
 Attacco universale  
 mm. 100 gr. 550 circa  
 " 90 " 300 "

**Maniglie tipo BRINDISI**  
 Attacco universale  
 mm. 102 gr. 440 circa  
 " 90 " 300 "

INDUSTRIA OTTONAMI E ALPACCA

**MANIGLIERIE**  
 FINE E COMUNI

---

**GHIDINI PIETRO & FIGLI**

---

LUMEZZANE S. APOLLONIO  
 ◆◆ (BRESCIA) ◆◆

TIPO-ISTO V. SAVIO - BRESCIA

15

63  
64  
65  
66  
67  
68  
69  
70

Fondata nel 1929, Ghidini Pietro Bosco e' oggi alla terza generazione di setione familiare, mantenendo intatti i valori che ne hanno segnato il successo.

Da sempre l'azienda ha saputo evolversi nel tempo, integrando tecnologie moderne e innovazione nel proprio settore. Ghidini Pietro Bosco si sviluppa in due siti produttivi, situati entrambi nella provincia di Brescia, zona con una lunga tradizione nella lavorazione del metallo.

Questa localizzazione strategica permette all'azienda di beneficiare dell'esperienza locale, assicurando al tempo stesso continuita' operativa e qualita' ai propri clienti.

Il controllo dei processi produttivi garantisce stabilita' sia ai suoi collaboratori che ai suoi partner.

**Founded in 1929, Ghidini Pietro Bosco is today in the third generation of the family business, keeping intact the values that have marked its success. The company has always been able to evolve over the time, integrating technologies and innovation in its sector.**

**Ghidini Pietro Bosco is spread across two production sites, both located in the province of Brescia, an area with a long tradition in metalworking. This strategic location allows the company to benefit from local know-how, while ensuring operational continuity and quality for its customers. The control of the production processes guarantees stability both to its collaborators and its partners.**



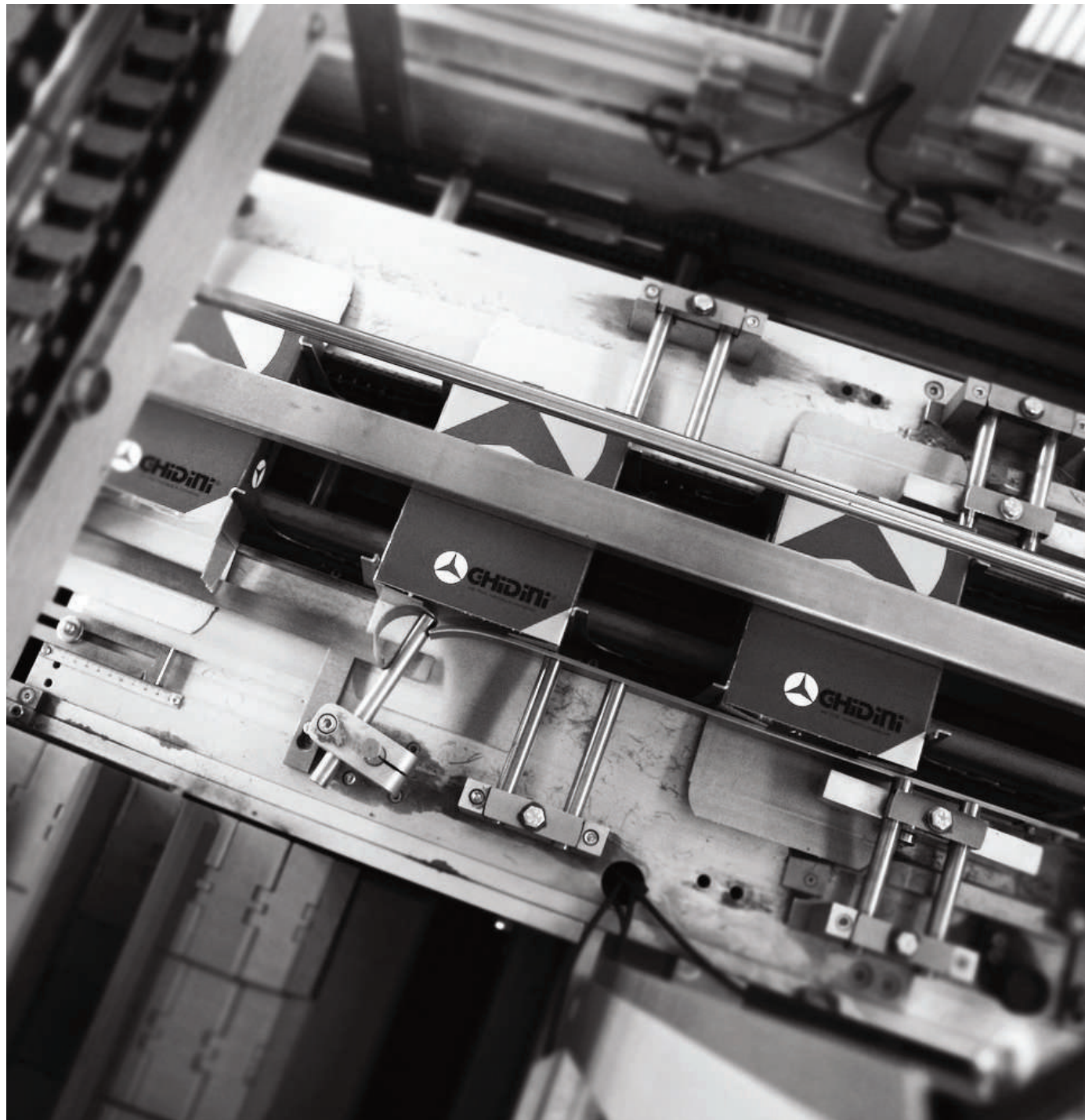



L'attenzione alla sostenibilità è da sempre un principio fondamentale dell'azienda. Già dagli inizi degli anni 60 l'azienda dispone di una produzione idroelettrica tramite un bacino artificiale realizzato nei pressi della sede, ancora attivo. Un'attenzione lungimirante anche alla luce delle attuali sfide ambientali. I materiali utilizzati, il controllo dei processi secondo le normative più aggiornate e la scelta di un packaging riciclabile e volto a ridurre i volumi di trasporto, ci permettono di contribuire a un futuro più sostenibile.

Ghidini rispetta i requisiti di legge in materia ambientale e dispone dei permessi e delle autorizzazioni necessari che vengono periodicamente mantenuti aggiornati.

Ghidini sviluppa costantemente strategie atte a ridurre il consumo di risorse energetiche ed idriche e la produzione di rifiuti riducendo l'impatto ambientale delle proprie attività con sofisticati sistemi di depurazione ed impianti a circuito chiuso.



Attention to sustainability has always guided our choices. Since the early 60s the company has had hydroelectric production via an artificial reservoir built near the headquarters, which is still active. A far-sighted focus also in light of current environmental challenges.

The materials used, the control of processes according to the most updated regulations and the choice of recyclable packaging aimed at reducing transport volumes, allow us to contribute to a more sustainable future.

Ghidini complies with environmental law requirements and has the necessary permits and authorizations which are periodically updated. Ghidini constantly develops strategies aimed at reducing the consumption of energy and water resources and the production of waste by reducing the environmental impact of its activities with sophisticated purification systems and closed-circuit plants.











# 1

**Maniglie e coordinati per  
porte e finestre**

**Door handles and door  
and window accessories**

20 Indice alfabetico maniglie / Alphabetical index handles  
22 Indice visual maniglie / Visual index handles

26 Alluminio galattico / Galactic Aluminum  
36 Zama / Zamak  
116 Ottone / Brass  
168 Alluminio / Aluminum

# Indice alfabetico maniglie

141	AL. GALATTICO	34	RIALTO	ZAMA	88
142	ALLUMINIO	174	SEVEN	ZAMA	90
143	ALLUMINIO	176	SEVEN	ALLUMINIO	210
144	ALLUMINIO	178	SEVEN Q	ZAMA	92
190	ALLUMINIO	180	SEVEN Q	ALLUMINIO	212
239	ALLUMINIO	182	SHARK	ZAMA	94
240	ALLUMINIO	184	SHARK	ALLUMINIO	214
2071	ALLUMINIO	222	SUSY - 2040	ALLUMINIO	216
7009	AL. GALATTICO	32	SWING	ZAMA	96
7900	ALLUMINIO	186	TIROL	OTTONE	164
7900	ALLUMINIO	188	TOY	ZAMA	98
2006 CUORE	ALLUMINIO	224	TOY Q	ZAMA	100
ARCHIMEDE	ALLUMINIO	190	UNIVERSAL	ALLUMINIO	218
ARIETE	OTTONE	122	UNO	OTTONE	166
BAROCCO	OTTONE	124	UNO	ALLUMINIO	220
BRIXIA	ALLUMINIO	192	UNO Z	ZAMA	102
CARLO	ALLUMINIO	194	VICTORIA	ZAMA	104
CARTER	ZAMA	42	WING	ALLUMINIO	106
CARTESIO	ZAMA	44	YORK	ZAMA	108
CARTESIO B/W	ZAMA	46	YORK 4	ZAMA	110
CARTESIO Q	ZAMA	48	YORK BERRY	ZAMA	112
CARTESIO Q B/W	ZAMA	50	YORK Q	ZAMA	114
CLIP	ZAMA	52			
DELTA	ALLUMINIO	196			
EASY	OTTONE	126			
EASY Q	OTTONE	128			
ELBA	OTTONE	130			
ELITE	OTTONE	132			
EUROPA 238	ALLUMINIO	198			
FARFALLA	ZAMA	54			
FERGIE	ZAMA	56			
GABRY	ALLUMINIO	200			
GALILEO	ZAMA	58			
GALILEO Q	ZAMA	60			
GINEVRA	OTTONE	134			
GM05	ZAMA	62			
GM07	ZAMA	64			
GM08	ZAMA	66			
GM10	ZAMA	68			
GM11	ZAMA	70			
GOLF	OTTONE	136			
IDEA	ZAMA	72			
IDEA Q	ZAMA	74			
ITACA 2005	ALLUMINIO	202			
JOLLY 210	ALLUMINIO	206			
LADY	OTTONE	138			
LEAF	ZAMA	76			
LEONARDO	ALLUMINIO	204			
LINEA	ZAMA	140			
LITZ	ZAMA	78			
MILENA	OTTONE	142			
MILENA Z	ZAMA	80			
NION	ZAMA	82			
NION Q	ZAMA	84			
NOVECENCO	OTTONE	144			
PIGNA	OTTONE	146			
PIGNA 2008	ALLUMINIO	208			
R5200	OTTONE	148			
R716	OTTONE	150			
R716	OTTONE	152			
R771	OTTONE	154			
R775	ZAMA	156			
R901	OTTONE	158			
R938	ZAMA	86			
R988	OTTONE	160			
R988	OTTONE	162			

# Alphabetical index handles

141	GALACTIC AL.	34	RIALTO	ZAMAK	88
142	ALUMINUM	174	SEVEN	ZAMAK	90
143	ALUMINUM	176	SEVEN	ALUMINUM	210
144	ALUMINUM	178	SEVEN Q	ZAMAK	92
190	ALUMINUM	180	SEVEN Q	ALUMINUM	212
239	ALUMINUM	182	SHARK	ZAMAK	94
240	ALUMINUM	184	SHARK	ALUMINUM	214
2071	ALUMINUM	222	SUSY - 2040	ALUMINUM	216
7009	GALACTIC AL.	32	SWING	ZAMAK	96
7900	ALUMINUM	186	TIROL	BRASS	164
7900	ALUMINUM	188	TOY	ZAMAK	98
2006 CUORE	ALUMINUM	224	TOY Q	ZAMAK	100
ARCHIMEDE	ALUMINUM	190	UNIVERSAL	ALUMINUM	218
ARIETE	BRASS	122	UNO	BRASS	166
BAROCCO	BRASS	124	UNO	ALUMINUM	220
BRIXIA	ALUMINUM	192	UNO Z	ZAMAK	102
CARLO	ALUMINUM	194	VICTORIA	ZAMAK	104
CARTER	ZAMAK	42	WING	ALUMINUM	106
CARTESIO	ZAMAK	44	YORK	ZAMAK	108
CARTESIO B/W	ZAMAK	46	YORK 4	ZAMAK	110
CARTESIO Q	ZAMAK	48	YORK BERRY	ZAMAK	112
CARTESIO Q B/W	ZAMAK	50	YORK Q	ZAMAK	114
CLIP	ZAMAK	52			
DELTA	ALUMINUM	196			
EASY	BRASS	126			
EASY Q	BRASS	128			
ELBA	BRASS	130			
ELITE	BRASS	132			
EUROPA 238	ALUMINUM	198			
FARFALLA	ZAMAK	54			
FERGIE	ZAMAK	56			
GABRY	ALUMINUM	200			
GALILEO	ZAMAK	58			
GALILEO Q	ZAMAK	60			
GINEVRA	BRASS	134			
GM05	ZAMAK	62			
GM07	ZAMAK	64			
GM08	ZAMAK	66			
GM10	ZAMAK	68			
GM11	ZAMAK	70			
GOLF	BRASS	136			
IDEA	ZAMAK	72			
IDEA Q	ZAMAK	74			
ITACA 2005	ALUMINUM	202			
JOLLY 210	ALUMINUM	206			
LADY	BRASS	138			
LEAF	ZAMAK	76			
LEONARDO	ALUMINUM	204			
LINEA	ZAMAK	140			
LITZ	ZAMAK	78			
MILENA	BRASS	142			
MILENA Z	ZAMAK	80			
NION	ZAMAK	82			
NION Q	ZAMAK	84			
NOVECEN TO	BRASS	144			
PIGNA	BRASS	146			
PIGNA 2008	ALUMINUM	208			
R5200	BRASS	148			
R716	BRASS	150			
R716	BRASS	152			
R771	BRASS	154			
R775	ZAMAK	156			
R901	BRASS	158			
R938	ZAMAK	86			
R988	BRASS	160			
R988	BRASS	162			

# Indice visuale maniglie

## Visual index handles

ALLUMINIO  
GALATTICO  
GALACTIC  
ALUMINUM



ZAMA  
ZAMAK

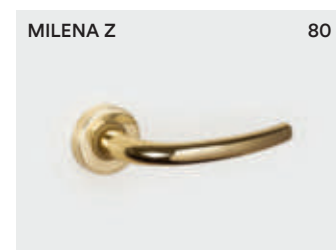
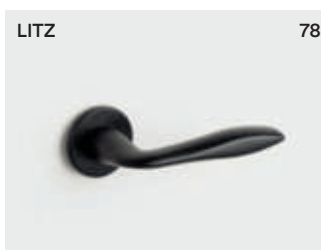
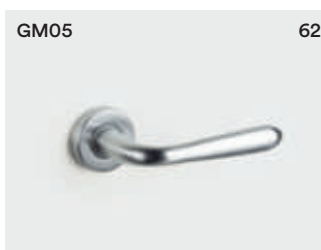
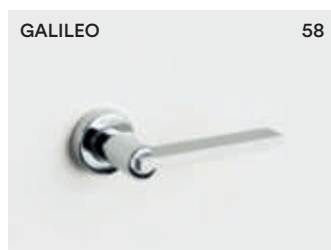
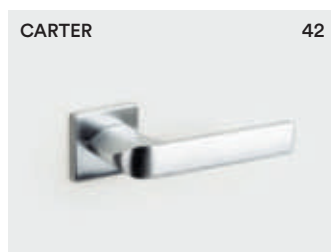



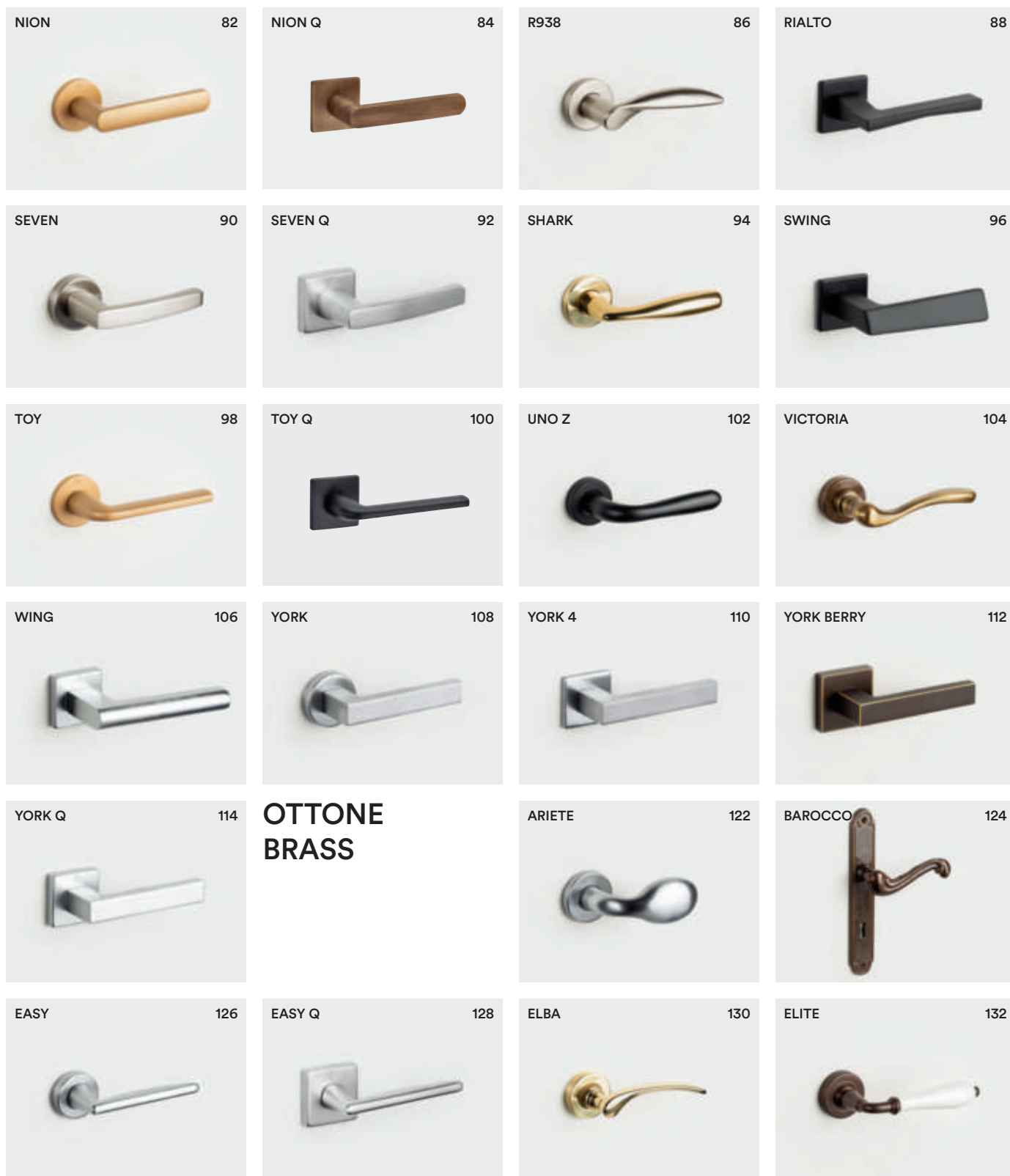

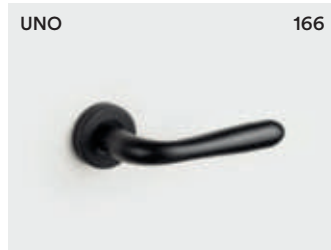
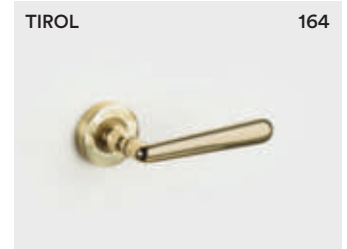
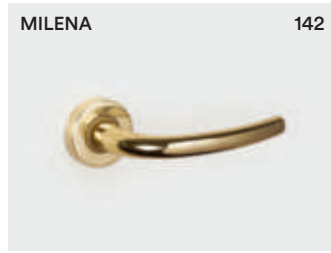
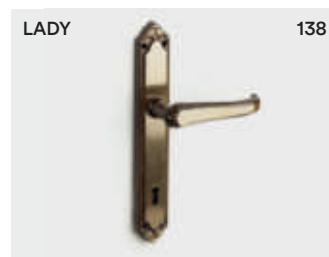
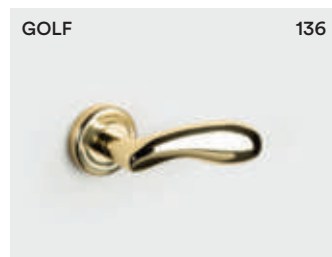
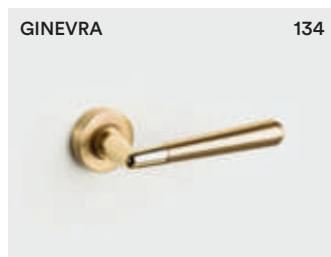

**ALLUMINIO  
ALUMINUM**

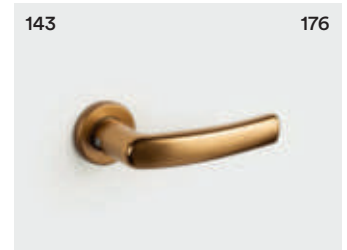

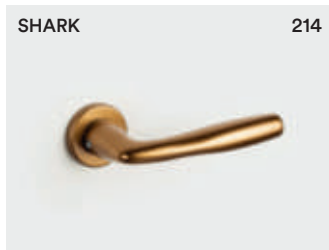

# Alluminio galattico

# Galactic Aluminum

28 Introduzione / Introduction  
30 Finiture / Finishes

32 7900  
34 141



Galactic Aluminum

Handles

Scopri le nuove finiture galattiche, disponibili per le maniglie 7900 e 141 e gli accessori dedicati. Una collezione completa che garantisce continuità di immagine.

Totalmente Made in Italy grazie alla produzione di prossimità, queste maniglie sono in alluminio, un materiale sostenibile e riciclabile.

L'alluminio è un materiale responsabile, grazie alla sua capacità di essere riutilizzato all'infinito con un basso consumo energetico, rendendolo fondamentale per un futuro più sostenibile.

La cosmesi del prodotto è studiata in modo da poter garantire lunga vita alle finiture e di conseguenza alle maniglie.

L'argento presente nella maniglia sprigiona gli ioni attivi che agiscono contro i batteri, dando il via ad un naturale e continuo processo antibatterico.

Find out the new galactic finishes, available for models 7900 and 141 and their coordinated accessories. A complete collection of handles that ensures a continuity of image.

Totally Made in Italy thanks to a proximity production, these handles are made of aluminum, a sustainable and recyclable material.

Aluminum is a responsible material, thanks to its ability to be endlessly reused with low energy consumption, making it essential for a more sustainable future.

The anodized finishes have a long-lasting resistance to weather conditions. The silver in the handle releases active ions that act against bacteria, giving rise to a natural and continuous antibacterial process.







1

2

# 7900

77900

7900

Galactic Aluminum



MERCURY



SPACE



URANUS



JUPITER



MERCURY

Handles

	MERCURY	URANUS	JUPITER	SPACE	Conf. Pz.
1 Q8 RBQ 50x4 C/M Guarnitura Q8 ros./bocc. QUADRA patent con molla Lever handle 8mm on square rose key hole escutcheon springloaded	77900241833	77900241834	77900241841	77900241876	1
1 Q8 RBQY 50x4 C/M Guarnitura Q8 ros./bocc. QUADRA Yale con molla Lever handle 8mm on square rose cyl hole escutcheon springloaded	77900245833	77900245834	77900245841	77900245876	1
1 Q8 RBQWC Q6 50x4 C/M Guarnitura Q8 ros./bocc. QUADRA Wc Q6 con molla Lever handle 8mm on square rose wc hole escutcheon 6mm springloaded	77900248833	77900248834	77900248841	77900248876	1
2 DK40 BUS, 9,5 7900 GHTEK DK40 BUS. 9,5 window handle DK x 40mm with pins D.9,5	77900583033	77900583034	77900583041	77900583076	2
2 DK45 BUS, 9,5 c/viti 7900 GHTEK DK45 BUS. 9,5 c/viti window handle DK x 45mm with pins D.9,5 and screws	7790058333391	7790058333491	7790058334191	7790058337691	2

⚡ Servizio G48: Articolo a magazzino e disponibile entro 48 dall'elaborazione dell'ordine. In base a disponibilita' e condizioni di vendita.  
G48 service: Item in stock and available within 48 hours of order processing. Based on availability and sales conditions.

77900

7900

## PORTA

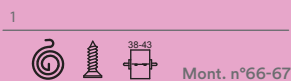
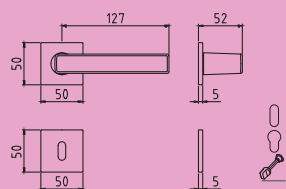

## FINESTRA

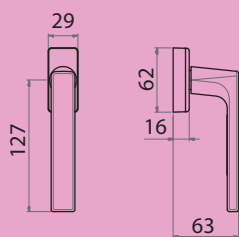

Per istruzioni di montaggio  
scansiona QR code,  
seleziona il numero di  
riferimento e segui le  
istruzioni.  
For assembly instructions  
scan the QR code, select the  
relevant assembly number  
and follow the instructions.

Alluminio galattico

Maniglie

# 141

70141

141

Galactic Aluminum



MERCURY



SPACE



URANUS



JUPITER



URANUS

Handles

	MERCURY	URANUS	JUPITER	SPACE	Conf. Pz.
1 Q8 RBQ 50x4 C/M Guarnitura Q8 ros./bocc. QUADRA patent con molla Lever handle 8mm on square rose key hole escutcheon springloaded	70141241733	70141241734	70141241741	70141241776	1
1 Q8 RBQY 50x4 C/M Guarnitura Q8 ros./bocc. QUADRA Yale con molla Lever handle 8mm on square rose cyl hole escutcheon springloaded	70141245733	70141245734	70141245741	70141245776	1
1 Q8 RBQWC Q6 50x4 C/M Guarnitura Q8 ros./bocc. QUADRA Wc Q6 con molla Lever handle 8mm on square rose wc hole escutcheon 6mm springloaded	70141248733	70141248734	70141248741	70141248776	1
2 DK x 40 C/BUSS D.9,5 141 DKx40 C/BUSS D.9,5 window handle DK x 40 mm with pins D.9,5	7014155803395	7014155803495	7014155804195	7014155807695	2
2 DK x 45 C/BUSS D.9,5 C/viti 141 DKx45 C/BUSS D.9,5 C/viti window handle DK x 45 mm with pins D.9,5 with screws	7014155843395	7014155843495	7014155844195	7014155847695	2

⚡ Servizio G48: Articolo a magazzino e disponibile entro 48 dall'elaborazione dell'ordine. In base a disponibilita' e condizioni di vendita.  
G48 service: Item in stock and available within 48 hours of order processing. Based on availability and sales conditions.

## PORTA

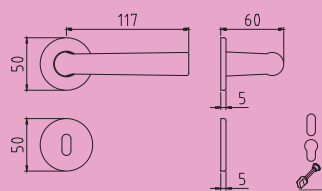

1



## FINESTRA

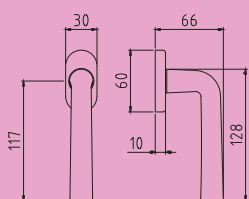

2



Per istruzioni di montaggio  
scansiona QR code,  
seleziona il numero di  
riferimento e segui le  
istruzioni.  
For assembly instructions  
scan the QR code, select the  
relevant assembly number  
and follow the instructions.

# Zama Zamak

38 Introduzione / Introduction  
40 Finiture / Finishes

42 CARTER  
44 CARTESIO  
46 CARTESIO B/W  
48 CARTESIO Q  
50 CARTESIO Q B/W  
52 CLIP  
54 FARFALLA  
56 FERGIE  
58 GALILEO  
60 GALILEO Q  
62 GM05  
64 GM07  
66 GM08  
68 GM10  
70 GM11  
72 IDEA  
74 IDEA Q  
76 LEAF  
78 LITZ  
80 MILENA Z  
82 NION  
84 NION Q  
86 R938  
88 RIALTO  
90 SEVEN  
92 SEVEN Q  
94 SHARK  
96 SWING  
98 TOY  
100 TOY Q  
102 UNO Z  
104 VICTORIA  
106 WING  
108 YORK  
110 YORK 4  
112 YORK BERRY  
114 YORK Q





**Zama é una speciale lega di zinco, alluminio e magnesio particolarmente adatta per pressofusione con cui produciamo articoli che, dopo operazioni di finitura superficiale, vengono sottoposti a trattamenti galvanici di doratura, nichelatura, rodiatura, cromatura nonché all'esclusivo trattamento GHI.CO.TEC.**

**Zamak is a special alloy of zinc, aluminium and magnesium which is particularly suitable for die casting, used to produce articles which, after surface finishing operations, undergo galvanic treatments with gold, nickel, rhodium and chrome as well as our exclusive GHI.CO.TEC. treatment.**

# Finiture Zama

## Zamak finishing



01



02



05



06



08



07



09

Zamak

Maniglie

ZCL-BLACK	01	41
CHAMPAGNE	02	
TITANIUM	03	
ZCL	04	
LORENA	05	
ZCS	06	
GCTOI	07	
ZNO-TITANIUM	08	
ZNS	09	
BORGOGNA	10	
ZCL-ZCS	11	
ZNO	12	
NORMANDIA	13	
ZGV	14	
Z-BGO	15	
Z-OSO	16	



04



14



03



12



13



11



16

Zama

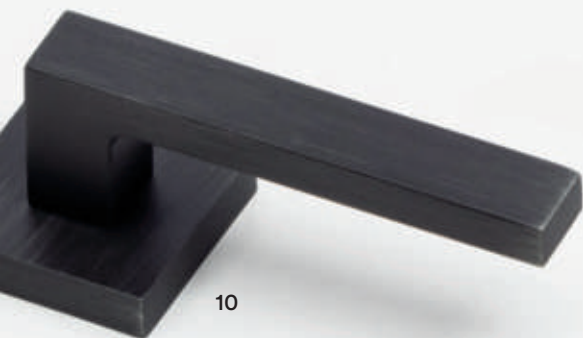

10



15

Maniglie

# CARTER

DESIGN MESSINEO E SETTIMELLI

66510

Carter

Zamak



ZCL



ZCS



ZNO



ZCS

Handles

	ZCL	ZCS	ZNO	Conf. Pz.
1 Q8 RQ Guarnitura Q8 ros. senza bocc. Lever handle 8mm on rose	66510240807	66510240813	66510240816	1
1 Q8 RBQ Guarnitura Q8 ros./bocc. patent Lever handle 8mm on rose key hole escutcheon	66510241807	66510241813	66510241816	1
1 Q8 RBQY Guarnitura Q8 ros./bocc. yale Lever handle 8mm on rose - cyl. hole escutcheon	66510245807	66510245813	66510245816	1
2 Q8 RBQWC Guarnitura Q8 ros./bocc. Wc Lever handle 8mm on rose wc hole escutcheon	66510248807	66510248813	66510248816	1
2 Q8 RBR Guarnitura Q8 ros./bocc. rett. patent molla dx/sx Lever handle 8mm on springloaded rect rose key hole esc	66510211407	66510211413	66510211416	1
2 Q8 RBRY Guarnitura Q8 ros./bocc. rett.yale molla dx/sx Lever handle 8mm on springloaded rect rose cylinder hole esc	66510215407	66510215413	66510215416	1
3 DK X 40 C/BUSS Martellina DK Q7 x 40 con bussole D. 9,5 gioco in ferro window handle DK x 40mm with pins D.9,5 iron mechanism	66510553807	66510553813	66510553816	2
4 DK X 40 ribassato Martellina DK Q7 x 40 ribassato window handle DK x 40 mm thin mechanism	66510594007	66510594013	66510594016	2

⚡ Servizio G48: Articolo a magazzino e disponibile entro 48 dall'elaborazione dell'ordine. In base a disponibilita' e condizioni di vendita.  
G48 service: Item in stock and available within 48 hours of order processing. Based on availability and sales conditions.

## PORTA

## FINESTRA

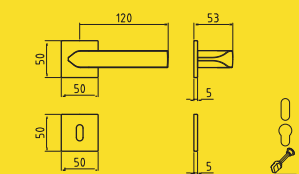

1 Ros 50x50x5  
(molla ambidestra - maniglia non solidale)

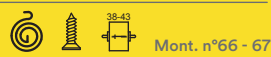

Mont. n°66 - 67

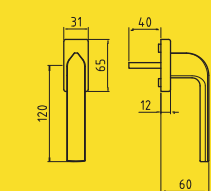

3 Gioco in ferro



Mont. n°6

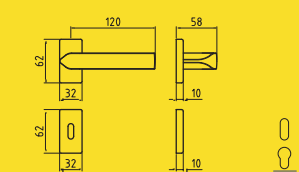

2 Ros 0006



Mont. n°75

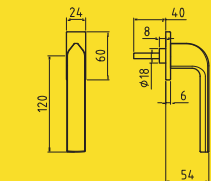

4



Mont. n°7



Per istruzioni di montaggio  
scansiona QR code,  
seleziona il numero di  
riferimento e segui le  
istruzioni.  
For assembly instructions  
scan the QR code, select the  
relevant assembly number  
and follow the instructions.

# CARTESIO

DESIGN FABRIZIO BIANCHETTI

55012

Cartesio

Zamak



ZCL/F1-SAT



ZCL/F1-SAT



ZCL/F1-SAT

Handles



	ZCL-F1-SAT	Conf. Pz.
1 Q8 R Guarnitura Q8 ros. senza bocc. Lever handle 8mm on rose	55012280054	1
1 Q8 RB Guarnitura Q8 ros./bocc. patent Lever handle 8mm on rose key hole escutcheon	55012281054	1
1 Q8 RBY Guarnitura Q8 ros./bocc. yale Lever handle 8mm on rose - cyl. hole escutcheon	55012285054	1
1 Q8 RBWC Guarnitura Q8 ros./bocc. Wc Lever handle 8mm on rose wc hole escutcheon	55012288054	1
2 Q8 ROC Guarnitura Q8 ros.ovale senza bocc.molla dx/sx Lever handle 8mm on springloaded oval rose	55012220554	1
2 Q8 RBOC Guarnitura ros./bocc. ovale patent molla dx/sx Lever handle 8mm on springloaded oval rose key hole escutcheon	55012221554	1
2 Q8 RBOYC Guarnitura Q8 ros/boc. ovale yale molla dx/sx Lever handle 8mm on springloaded oval rose - cyl. hole escutcheon	55012225554	1
3 EZ IM Cremonese gioco EZ imp. maniglia Mechanism for window handle spindle 7 mm	55012456054	2
3 EZQ7 IM Cremonese gioco EZ + Q7 imp. maniglia Mechanism for window handle spindle 7 mm	55012457054	2
3 MART IM Martellina Q7 imp. Maniglia lever window handle	55012550054	2
4 DK X 40 Martellina DK Q7 x 40 window handle DK x 40 mm	55012557054	2
4 DK X 40 C/BUSS Martellina DK Q7 x 40 con bussole D. 9,5 window handle DK x 40mm with pins D.9,5	55012558054	2

55012

Cartesio

## PORTA

## FINESTRA

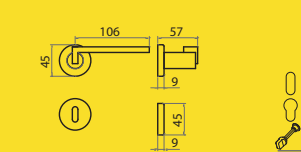

1 Ros 45x9



Mont. n°88-89

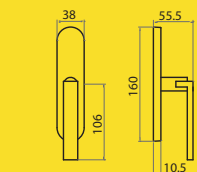

3

Mont. n°140-141

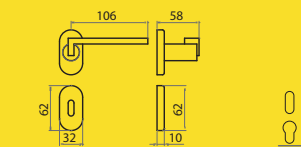

2 Ros 0006



Mont. n°25

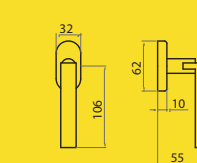

4



Mont. n°4



Per istruzioni di montaggio scansiona QR code, seleziona il numero di riferimento e segui le istruzioni.  
For assembly instructions scan the QR code, select the relevant assembly number and follow the instructions.

Zama

Maniglie

# CARTESIO B/W

DESIGN FABRIZIO BIANCHETTI

55012

Cartesio B/W

Zamak



OCL/WHITE (RAL 9010 OPACO)



OCL/BLACK



OCL/WHITE (RAL 9010 OPACO)



OCL/BLACK



ZCL/F1-SAT

Handles

	ZCL-WHITE	ZCL-BLACK	Conf. Pz.
1 Q8 R Guarnitura Q8 ros. senza bocc. Lever handle 8mm on rose	55012280077	55012280086	1
1 Q8 RB Guarnitura Q8 ros./bocc. patent Lever handle 8mm on rose key hole escutcheon	55012281077	55012281086	1
1 Q8 RBY Guarnitura Q8 ros./bocc. yale Lever handle 8mm on rose - cyl. hole escutcheon	55012285077	55012285086	1
1 Q8 RBWC Guarnitura Q8 ros./bocc. Wc Lever handle 8mm on rose wc hole escutcheon	55012288077	55012288086	1
2 Q8 ROC Guarnitura Q8 ros.ovale senza bocc.molla dx/sx Lever handle 8mm on springloaded oval rose	55012220577	55012220586	1
2 Q8 RBOC Guarnitura ros./bocc. ovale patent molla dx/sx Lever handle 8mm on springloaded oval rose key hole escutcheon	55012221577	55012221586	1
2 Q8 RBOYC Guarnitura Q8 ros/boc. ovale yale molla dx/sx Lever handle 8mm on springloaded oval rose - cyl. hole escutcheon	55012225577	55012225586	1
3 EZ IM Cremonese gioco EZ imp. maniglia Mechanism for window handle spindle 7 mm	55012456077	55012456086	2
3 EZQ7 IM Cremonese gioco EZ + Q7 imp. maniglia Mechanism for window handle spindle 7 mm	55012457077	55012457086	2
3 MART IM Martellina Q7 imp. Maniglia lever window handle	55012550077	55012550086	2
4 DK X 40 Martellina DK Q7 x 40 window handle DK x 40 mm	55012557077	55012557086	2
4 DK X 40 C/BUSS Martellina DK Q7 x 40 con bussole D. 9,5 window handle DK x 40mm with pins D.9,5	55012558077	55012558086	2

55012

Cartesio B/W

## PORTA

## FINESTRA

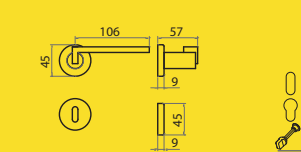

1 Ros 45x9



Mont. n°88-89

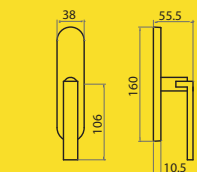

3

Mont. n°140-141

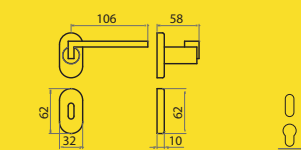

2 Ros 0006



Mont. n°25

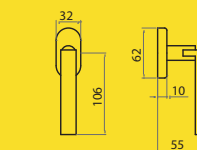

4



Mont. n°4



Per istruzioni di montaggio  
scansiona QR code,  
seleziona il numero di  
riferimento e segui le  
istruzioni.  
For assembly instructions  
scan the QR code, select the  
relevant assembly number  
and follow the instructions.

# CARTESIO Q

DESIGN FABRIZIO BIANCHETTI

44994

Cartesio Q

Zamak



ZCL/F1-SAT



ZCL/F1-SAT

Handles

	ZCL-F1-SAT	Conf. Pz.
1 Q8 RBQ Guarnitura Q8 ros./bocc. patent Lever handle 8mm on rose key hole escutcheon	44994281054	1
1 Q8 RBQY Guarnitura Q8 ros./bocc. yale Lever handle 8mm on rose - cyl. hole escutcheon	44994285054	1
1 Q8 RBQWC Guarnitura Q8 ros./bocc. Wc Lever handle 8mm on rose wc hole escutcheon	44994288054	1
2 Q8 RBR Guarnitura Q8 ros./bocc. rett. patent molla dx/sx Lever handle 8mm on springloaded rectangular rose key hole escutcheon	44994211454	1
2 Q8 RBYR Guarnitura Q8 ros./bocc. rett. yale molla dx/sx Lever handle 8mm on springloaded rectangular rose - cyl. hole escutcheon	44994215454	1
3 DK X 40 Martellina DK Q7 x 40 window handle DK x 40 mm	44994557054	2
3 DK X 40 C/BUSS Martellina DK Q7 x 40 con bussole D. 9,5 window handle DK x 40mm with pins D.9,5	44994558054	2

44994

Cartesio Q

## PORTA

## FINESTRA

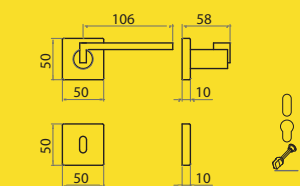

1 Ros 50x50x10 ALL



Mont. n°57-58

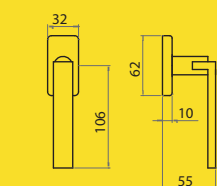

3



Mont. n°6

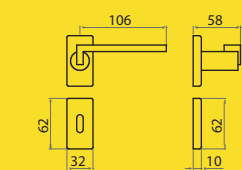

2



Mont. n°75



Per istruzioni di montaggio  
scansiona QR code,  
seleziona il numero di  
riferimento e segui le  
istruzioni.  
For assembly instructions  
scan the QR code, select the  
relevant assembly number  
and follow the instructions.

Zama

Maniglie

# CARTESIO Q B/W

DESIGN FABRIZIO BIANCHETTI

44994

Cartesio Q B/W

Zamak



OCL/WHITE (RAL 9010 OPACO)



OCL/BLACK



OCL/WHITE (RAL 9010 OPACO)



OCL/BLACK

Handles



	ZCL-WHITE	ZCL-BLACK	Conf. Pz.
1 Q8 RBQ Guarnitura Q8 ros./bocc. patent Lever handle 8mm on rose key hole escutcheon	44994241677	44994241686	1
1 Q8 RBQY Guarnitura Q8 ros./bocc. yale Lever handle 8mm on rose - cyl. hole escutcheon	44994245677	44994245686	1
1 Q8 RBQWC Guarnitura Q8 ros./bocc. Wc Lever handle 8mm on rose wc hole escutcheon	44994248677	44994248686	1
2 Q8 RBR Guarnitura Q8 ros./bocc. rett. patent molla dx/sx Lever handle 8mm on springloaded rectangular rose key hole escutcheon	44994211477	44994211486	1
2 Q8 RBYR Guarnitura Q8 ros./bocc. rett. yale molla dx/sx Lever handle 8mm on springloaded rectangular rose - cyl. hole escutcheon	44994215477	44994215486	1
3 DK X 40 Martellina DK Q7 x 40 window handle DK x 40 mm	44994557077	44994557086	2
3 DK X 40 C/BUSS Martellina DK Q7 x 40 con bussole D. 9,5 window handle DK x 40mm with pins D.9,5	44994558077	44994558086	2

44994

Cartesio Q B/W

## PORTA

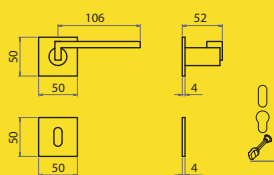

1 Ros 50x50x10 ALL



Mont. n°66-67

## FINESTRA

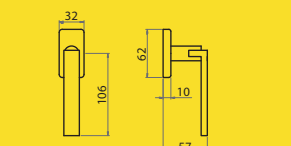

3

Mont. n°6

2

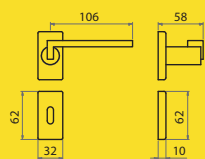

Mont. n°75



Per istruzioni di montaggio  
scansiona QR code,  
seleziona il numero di  
riferimento e segui le  
istruzioni.  
For assembly instructions  
scan the QR code, select the  
relevant assembly number  
and follow the instructions.

Zama

Maniglie

# CLIP

XXY DESIGN

66530

Clip

Zamak



ZCL-ZCS



ZCS-BLACK



ZNO-TITANIUM

Handles



ZCS-BLACK

	ZNO-TITANIUM	ZCS-BLACK	ZCL-ZCS	Conf. Pz.
1 Q8 R Guarnitura Q8 ros. senza bocc. Lever handle 8mm on rose	66530230518	66530230521	66530230559	1
1 Q8 RB Guarnitura Q8 ros./bocc. patent Lever handle 8mm on rose key hole escutcheon	66530231518	66530231521	66530231559	1
1 Q8 RBY Guarnitura Q8 ros./bocc. yale Lever handle 8mm on rose - cyl. hole escutcheon	66530235518	66530235521	66530235559	1
2 Q8 RBOC Guarnitura ros./bocc. ovale patent molla dx/sx Lever handle 8mm on springloaded oval rose key hole escutcheon	66530221518	66530221521	66530221559	1
2 Q8 RBOYC Guarnitura Q8 ros/boc. ovale yale molla dx/sx Lever handle 8mm on springloaded oval rose - cyl. hole escutcheon	66530225518	66530225521	66530225559	1
2 Q8 RBWC Guarnitura Q8 ros./bocc. Wc Lever handle 8mm on rose - wc 6mm function	66530238518	66530238521	66530238559	1
3 DK X 40 C/BUSS Martellina DK Q7 x 40 con bussole D. 9,5 gioco in ferro window handle DK x 40mm with pins D.9,5 iron mechanism	66530549518	66530549521	66530549559	2

66530

Clip

## PORTA

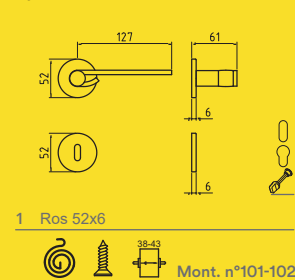

## FINESTRA

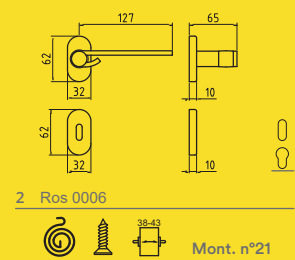
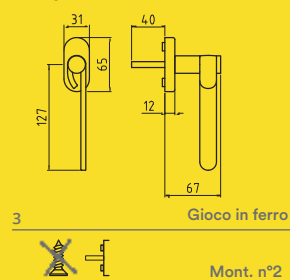

Per istruzioni di montaggio  
scansiona QR code,  
seleziona il numero di  
riferimento e segui le  
istruzioni.  
For assembly instructions  
scan the QR code, select the  
relevant assembly number  
and follow the instructions.

Zama

Maniglie

# FARFALLA

DESIGN FRANCESCO LUCCHESI

66525

Farfalla

Zamak



ZCL



ZCS



ZNO



TITANIUM

Handles



ZCS

	ZCL	ZCS	ZNO	TITANIUM	Conf. Pz.
1 Q8 R Guarnitura Q8 ros. senza bocc. Lever handle 8mm on rose	66525230507	66525230513	66525230516	66525230554	1
1 Q8 RB Guarnitura Q8 ros./bocc. patent Lever handle 8mm on rose key hole escutcheon	66525231507	66525231513	66525231516	66525231554	1
1 Q8 RBY Guarnitura Q8 ros./bocc. yale Lever handle 8mm on rose - cyl. hole escutcheon	66525235507	66525235513	66525235516	66525235554	1
2 Q8 RBOC Guarnitura ros./bocc. ovale patent molla dx/sx Lever handle 8mm on springloaded oval rose key hole escutcheon	66525221507	66525221513	66525221516	66525221554	1
2 Q8 RBOYC Guarnitura Q8 ros/boc. ovale yale molla dx/sx Lever handle 8mm on springloaded oval rose - cyl. hole escutcheon	66525225507	66525225513	66525225516	66525225554	1
2 Q8 RBWC Guarnitura Q8 ros./bocc. Wc Lever handle 8mm on rose - wc 6mm function	66525238507	66525238513	66525238516	66525238554	1
3 DK X 40 C/BUSS Martellina DK Q7 x 40 con bussole D. 9,5 gioco in ferro window handle DK x 40mm with pins D.9,5 iron mechanism	66525549507	66525549513	66525549516	66525549554	2

66525

Farfalla

## PORTA

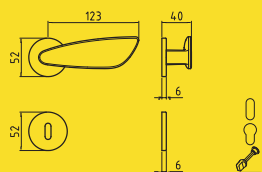

1 Ros 52x6



## FINESTRA

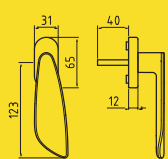

3

Gioco in ferro

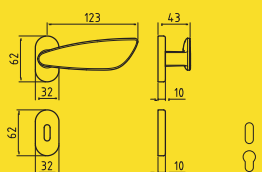

2 Ros 0006



Per istruzioni di montaggio  
scansiona QR code,  
seleziona il numero di  
riferimento e segui le  
istruzioni.  
For assembly instructions  
scan the QR code, select the  
relevant assembly number  
and follow the instructions.

Zama

Maniglie

# FERGIE

DESIGN XXY DESIGN

66535

Fergie

Zamak



ZCL



ZCS



ZNO

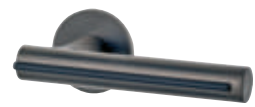

TITANIUM

Handles



ZCS



	ZCL	ZCS	ZNO	TITANIUM	Conf. Pz.
1 Q8 R Guarnitura Q8 ros. senza bocc. Lever handle 8mm on rose	66355230507	66355230513	66355230516	66355230554	1
1 Q8 RB Guarnitura Q8 ros./bocc. patent Lever handle 8mm on rose key hole escutcheon	66535231507	66535231513	66535231516	66535231554	1
1 Q8 RBY Guarnitura Q8 ros./bocc. yale Lever handle 8mm on rose - cyl. hole escutcheon	66535235507	66535235513	66535235516	66535235554	1
2 Q8 RBOC Guarnitura ros./bocc. ovale patent molla dx/sx Lever handle 8mm on springloaded oval rose key hole escutcheon	66535221507	66535221513	66535221516	66535221554	1
2 Q8 RBOYC Guarnitura Q8 ros/boc. ovale yale molla dx/sx Lever handle 8mm on springloaded oval rose - cyl. hole escutcheon	66535225507	66535225513	66535225516	66535225554	1
2 Q8 RBWC Guarnitura Q8 ros./bocc. Wc Lever handle 8mm on rose - wc 6mm function	66535238507	66535238513	66535238516	66535238554	1
3 DK X 40 C/BUSS Martellina DK Q7 x 40 con bussole D. 9,5 gioco in ferro window handle DK x 40mm with pins D.9,5 iron mechanism	66535549507	66535549513	66535549516	66535549554	2

66535

Fergie

## PORTA

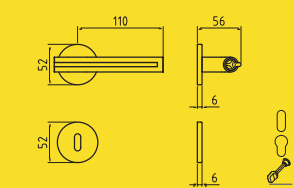

1 Ros 52x6



## FINESTRA

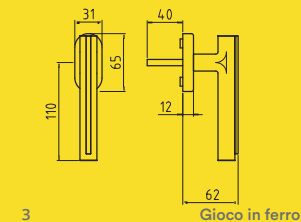

3

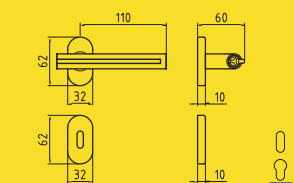

2 Ros 0006



Per istruzioni di montaggio  
scansiona QR code,  
seleziona il numero di  
riferimento e segui le  
istruzioni.  
For assembly instructions  
scan the QR code, select the  
relevant assembly number  
and follow the instructions.

Zama

Maniglie

# GALILEO

55112

Galileo

Zamak



ZCL/F1-SAT



ZCL/F1-SAT



ZCL/F1-SAT

Handles

	ZCL-F1-SAT	Conf. Pz.
1 Q8 R Guarnitura Q8 ros. senza bocc. Lever handle 8mm on rose	55112280054	1
1 Q8 RB Guarnitura Q8 ros./bocc. patent Lever handle 8mm on rose key hole escutcheon	55112281054	1
1 Q8 RBY Guarnitura Q8 ros./bocc. yale Lever handle 8mm on rose - cyl. hole escutcheon	55112285054	1
1 Q8 RBWC Guarnitura Q8 ros./bocc. Wc Lever handle 8mm on rose wc hole escutcheon	55112288054	1
2 Q8 ROC Guarnitura Q8 ros.ovale senza bocc.molla dx/sx Lever handle 8mm on springloaded oval rose	55112220554	1
2 Q8 RBOC Guarnitura ros./bocc. ovale patent molla dx/sx Lever handle 8mm on springloaded oval rose key hole escutcheon	55112221554	1
2 Q8 RBOYC Guarnitura Q8 ros/boc. ovale yale molla dx/sx Lever handle 8mm on springloaded oval rose - cyl. hole escutcheon	55112225554	1
3 EZ IM Cremonese gioco EZ imp. maniglia Mechanism for window handle spindle 7 mm	55112456054	2
3 EZQ7 IM Cremonese gioco EZ + Q7 imp. maniglia Mechanism for window handle spindle 7 mm	55112457054	2
3 MART IM Martellina Q7 imp. Maniglia lever window handle	55112550054	2
4 DK X 40 Martellina DK Q7 x 40 window handle DK x 40 mm	55112557054	2
4 DK X 40 C/BUSS Martellina DK Q7 x 40 con bussole D. 9,5 window handle DK x 40mm with pins D.9,5	55112558054	2

## PORTA

## FINESTRA

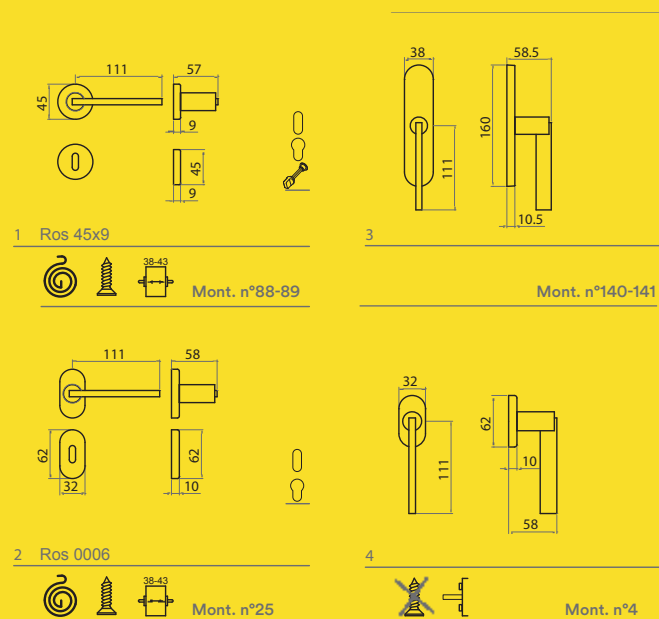

Per istruzioni di montaggio  
scansiona QR code,  
seleziona il numero di  
riferimento e segui le  
istruzioni.  
For assembly instructions  
scan the QR code, select the  
relevant assembly number  
and follow the instructions.

# GALILEO Q

DESIGN UFFICIO ESPERIENZE GHIDINI

44996

Galileo Q

Zamak



ZCL/F1-SAT



ZCL/F1-SAT

Handles

	ZCL-F1-SAT	Conf. Pz.
1 Q8 RBQ Guarnitura Q8 ros./bocc. patent Lever handle 8mm on rose key hole escutcheon	44996281054	1
1 Q8 RBQY Guarnitura Q8 ros./bocc. yale Lever handle 8mm on rose - cyl. hole escutcheon	44996285054	1
1 Q8 RBQWC Guarnitura Q8 ros./bocc. Wc Lever handle 8mm on rose wc hole escutcheon	44996288054	1
2 Q8 RBR Guarnitura Q8 ros./bocc. rett. patent molla dx/sx Lever handle 8mm on springloaded rect rose key hole esc	44996211454	1
2 Q8 RBYR Guarnitura Q8 ros./bocc. rett. yale molla dx/sx Lever handle 8mm on springloaded rect rose - cyl. hole esc	44996215454	1
3 DK X 40 Martellina DK Q7 x 40 window handle DK x 40 mm	44996557054	2
3 DK X 40 C/BUSS Martellina DK Q7 x 40 con bussole D. 9,5 window handle DK x 40mm with pins D.9,5	44996558054	2

44996

Galileo Q

## PORTA

## FINESTRA

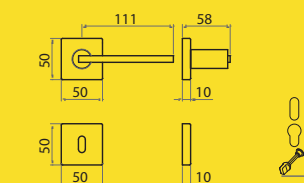

1 Ros 50x50x10 ALL



Mont. n°57-58

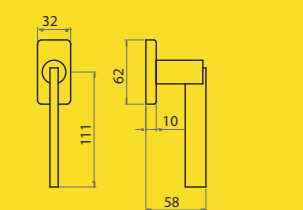

3



Mont. n°6

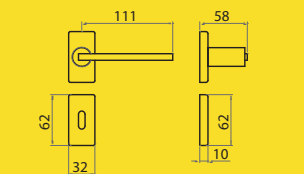

2



Mont. n°75



Per istruzioni di montaggio  
scansiona QR code,  
seleziona il numero di  
riferimento e segui le  
istruzioni.  
For assembly instructions  
scan the QR code, select the  
relevant assembly number  
and follow the instructions.

Zama

Maniglie

# GM05

6GM05

GM05

Zamak



ZCS



ZGV



ZCL



ZOS



GCTOL

Handles



	ZCS	ZCS/F1-SAT	ZCS/F1-SAT/GSH	GCTOL	GCTOL/GSH	ZCL	ZGV	Conf. Pz.
1 Q8 R Guarnitura Q8 ros. senza bocc. Lever handle 8mm on rose		6GM59280013		6GM58280012		6GM58280007	6GM58280004	1
1 Q8 RB Guarnitura Q8 ros./bocc. patent Lever handle 8mm on rose key hole escutcheon		6GM59281013	6GM59281013S	6GM58281012	6GM58281012S	6GM58281007	6GM58281004	1
1 Q8 RBY Guarnitura Q8 ros./bocc. yale Lever handle 8mm on rose - cyl. hole escutcheon		6GM59285013	6GM59285013S	6GM58285012	6GM58285012S	6GM58285007	6GM58285004	1
1 Q8 RBWC Guarnitura Q8 ros./bocc. Wc Lever handle 8mm on rose wc hole escutcheon		6GM59288013		6GM58288012		6GM58288007	6GM58288004	1
2 Q8 ROC Guarnitura Q8 ros.ovale senza bocc. Lever handle 8mm on oval rose	6GM58220513			6GM58220512		6GM58220507	6GM58220504	1
2 Q8 RBOC Guarnitura Q8 ros/boc. ovale patent Lever handle 8mm on oval rose key hole escutcheon	6GM58221513			6GM58221512		6GM58221507	6GM58221504	1
2 Q8 RBOYC Guarnitura Q8 ros/boc. ovale Yale Lever handle 8mm on oval rose - cyl. hole escutcheon	6GM58225513			6GM58225512		6GM58225507	6GM58225504	1
3 DK X 40 Martellina DK Q7 x 40 window handle DK x 40 mm	6GM58557013			6GM58557012		6GM58557007	6GM58557004	2
3 DK X 40 C/BUSS. Martellina DK Q7 x 40 con bussole D. 9,5 window handle DK x 40mm with pins D.9,5	6GM58558013			6GM58558012		6GM58558007	6GM58558004	2

⚡ Servizio G48: Articolo a magazzino e disponibile entro 48 dall'elaborazione dell'ordine. In base a disponibilita' e condizioni di vendita.  
G48 service: Item in stock and available within 48 hours of order processing. Based on availability and sales conditions.

## PORTA

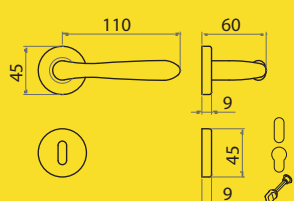

1 Ros 45x9



Mont. n°88-89

## FINESTRA

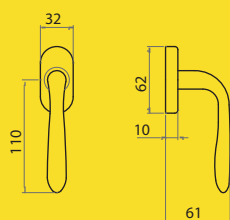

3



Mont. n°8

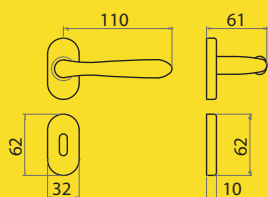

2



Mont. n°25



Per istruzioni di montaggio  
scansiona QR code,  
seleziona il numero di  
riferimento e segui le  
istruzioni.  
For assembly instructions  
scan the QR code, select the  
relevant assembly number  
and follow the instructions.

# GM07

6GM07

GM07

Zamak



Handles



	ZCL	ZCS	Conf. Pz.
1 Q8 RQ Guarnitura Q8 ros. senza bocc. Lever handle 8mm on rose	6GM07240507	6GM07240513	1
1 Q8 RBQ Guarnitura Q8 ros./bocc. patent Lever handle 8mm on rose key hole escutcheon	6GM07241507	6GM07241513	1
1 Q8 RBQY Guarnitura Q8 ros./bocc. yale Lever handle 8mm on rose - cyl. hole escutcheon	6GM07245507	6GM07245513	1
1 Q8 RBQWC Guarnitura Q8 ros./bocc. Wc Lever handle 8mm on rose wc hole escutcheon	6GM07248007	6GM07248013	1
2 Q8 RRC Guarnitura Q8 ros. senza bocc. con molla Lever handle 8mm on springloaded rectangular rose	6GM07210407	6GM07210413	1
2 Q8 RBR Guarnitura Q8 ros./bocc. patent con molla Lever handle 8mm on springloaded rect rose key hole esc	6GM07211407	6GM07211413	1
2 Q8 RBYR Guarnitura Q8 ros./bocc. rett.yale molla dx/sx Lever handle 8mm on springloaded rect rose - cyl. hole esc	6GM07215407	6GM07215413	1
3 DK x 40 Martellina DK Q7 x 40 window handle DK x 40 mm	6GM07555007	6GM07555013	2
3 DK X 40 C/BUS Martellina DK Q7 x 40 con bussole D. 9,5 window handle DK x 40mm with pins D.9,5	6GM07556007	6GM07556013	2

6GM07

GM07

## PORTA

## FINESTRA

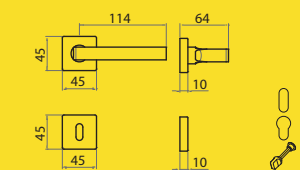

1 Ros 45x45

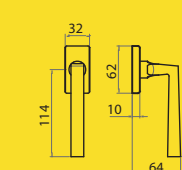
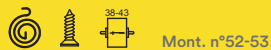

3

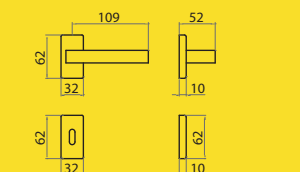

2



Per istruzioni di montaggio  
scansiona QR code,  
seleziona il numero di  
riferimento e segui le  
istruzioni.  
For assembly instructions  
scan the QR code, select the  
relevant assembly number  
and follow the instructions.

Zama

Maniglie

# GM08

6GM08

GM08

Zamak



ZCL



ZCS

	ZCS	ZCS/F1-SAT	ZCS/GSH	ZCL	Conf. Pz.
1 Q8 RQ Guarnitura Q8 ros. senza bocc. Lever handle 8mm on rose		6GM08240313		6GM08240007	1
1 Q8 RBQ Guarnitura Q8 ros./bocc. patent Lever handle 8mm on rose key hole escutcheon		6GM08241313	6GM08241013S	6GM08241007	1
1 Q8 RBQY Guarnitura Q8 ros./bocc. yale Lever handle 8mm on rose - cyl. hole escutcheon		6GM08245313	6GM08245013S	6GM08245007	1
1 Q8 RBQWC Guarnitura Q8 ros./bocc. Wc Lever handle 8mm on rose wc hole escutcheon		6GM08248313	6GM08248013S	6GM08248007	1
2 Q8 RRC guarnitura rosetta rettangolare Q8 C/M molla dx/sx Lever handle 8mm on springloaded rectangular rose	6GM08210413			6GM08210407	1
2 Q8 RBR Guarnitura Q8 ros./bocc. rett. patent molla dx/sx Lever handle 8mm on springloaded rect rose key hole esc	6GM08211413			6GM08211407	1
2 Q8 RBYR Guarnitura Q8 ros./bocc. rett.yale molla dx/sx Lever handle 8mm on springloaded rect rose - cyl. hole esc	6GM08215413			6GM08215407	1
3 DK X 40 Martellina DK Q7 x 40 window handle DK x 40 mm	6GM08555013			6GM08555007	2
3 DK X 40 C/BUSS. Martellina DK Q7 x 40 con bussole D. 9,5 window handle DK x 40mm with pins D.9,5	6GM08556013			6GM08556007	2

⚡ Servizio G48: Articolo a magazzino e disponibile entro 48 dall'elaborazione dell'ordine. In base a disponibilita' e condizioni di vendita.  
G48 service: Item in stock and available within 48 hours of order processing. Based on availability and sales conditions.

## PORTA

## FINESTRA

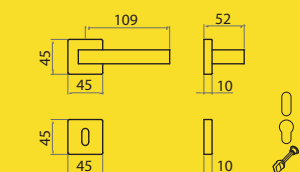

1 Ros 45x45  
Mont. n°50-51

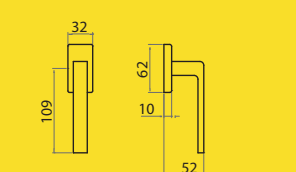

3 Mont. n°6

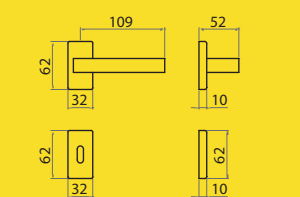

2 Mont. n°75



Per istruzioni di montaggio scansiona QR code, seleziona il numero di riferimento e segui le istruzioni.  
For assembly instructions scan the QR code, select the relevant assembly number and follow the instructions.

# GM10

6GM10

GM10

Zamak



ZCL



ZCS



ZNO



ZCS

Handles

	ZCL	ZCS	ZNO	Conf. Pz.
1 Q8 RQ Guarnitura Q8 ros. senza bocc. Lever handle 8mm on rose	6GM10240607	6GM10240613	6GM10240616	1
1 Q8 RBQ Guarnitura Q8 ros./bocc. patent Lever handle 8mm on rose key hole escutcheon	6GM10241607	6GM10241613	6GM10241616	1
1 Q8 RBQY Guarnitura Q8 ros./bocc. yale Lever handle 8mm on rose - cyl. hole escutcheon	6GM10245607	6GM10245613	6GM10245616	1
2 Q8 RRC guarnitura rosetta rettangolare Q8 C/M molla dx/sx Lever handle 8mm on springloaded rectangular rose	6GM10210407	6GM10210413	6GM10210416	1
2 Q8 RBR Guarnitura Q8 ros./bocc. rett. patent molla dx/sx Lever handle 8mm on springloaded rect rose key hole esc	6GM10211407	6GM10211413	6GM10211416	1
2 Q8 RBYR Guarnitura Q8 ros./bocc. rett.yale molla dx/sx Lever handle 8mm on springloaded rect rose - cyl. hole esc	6GM10215407	6GM10215413	6GM10215416	1
2 Q8 RBQWC Guarnitura Q8 ros./bocc. Wc Lever handle 8mm on rose wc hole escutcheon	6GM10248607	6GM10248613	6GM10248616	1
3 DK X 40 Martellina DK Q7 x 40 window handle DK x 40 mm	6GM10555007	6GM10555013	6GM10555016	2
3 DK X 40 C/BUSS. Martellina DK Q7 x 40 con bussole D. 9,5 window handle DK x 40mm with pins D.9,5	6GM10556007	6GM10556013	6GM10556016	2

6GM10

GM10

## PORTA

## FINESTRA

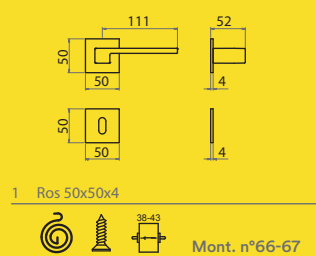

1 Ros 50x50x4

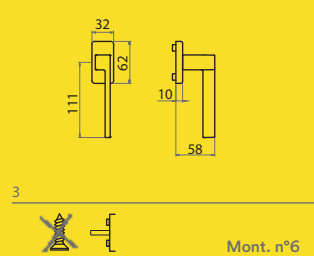

3

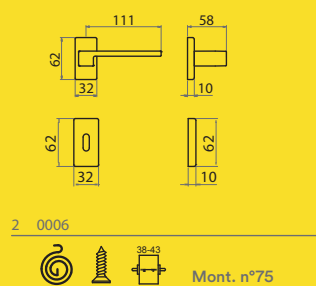

2 0006



Per istruzioni di montaggio  
scansiona QR code,  
seleziona il numero di  
riferimento e segui le  
istruzioni.  
For assembly instructions  
scan the QR code, select the  
relevant assembly number  
and follow the instructions.

Zama

Maniglie



# GM11

6GM11

GM11

Zamak



Handles



ZCL



ZCS

	ZCS	ZCS-MET	ZCS-GSH	ZCL	ZNO	Conf. Pz.
1 Q8 RQ Guarnitura Q8 ros. senza bocc. Lever handle 8mm on rose		6GM11240313		6GM11240507	6GM11240516	1
1 Q8 RBQ Guarnitura Q8 ros./bocc. patent Lever handle 8mm on rose key hole escutcheon		6GM11241313	6GM11241513S	6GM11241507	6GM11241516	1
1 Q8 RBQY Guarnitura Q8 ros./bocc. yale Lever handle 8mm on rose - cyl. hole escutcheon		6GM11245313	6GM11245513S	6GM11245507	6GM11245516	1
1 Q8 RBQWC Guarnitura Q8 ros./bocc. Wc Lever handle 8mm on rose wc hole escutcheon		6GM11248313	6GM11248013S	6GM11248007		1
2 Q8 RBR Guarnitura Q8 ros./bocc. rett. patent molla dx/sx Lever handle 8mm on springloaded rect rose key hole esc	6GM11211413			6GM11211407		1
2 Q8 RBYR Guarnitura Q8 ros./bocc. rett.yale molla dx/sx Lever handle 8mm on springloaded rect rose - cyl. hole esc	6GM11215413			6GM11215407		1
3 DK X 40 C/BUSS. Martellina DK Q7 x 40 con bussole D. 9,5 window handle DK x 40mm with pins D.9,5	6GM11553813			6GM11553807		2

⚡ Servizio G48: Articolo a magazzino e disponibile entro 48 dall'elaborazione dell'ordine. In base a disponibilita' e condizioni di vendita.  
G48 service: Item in stock and available within 48 hours of order processing. Based on availability and sales conditions.

## PORTA

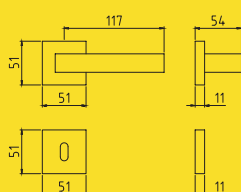

1 Ros. 50x50x11



Mont. n°57-58

## FINESTRA

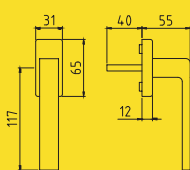

3

Gioco in ferro



Mont. n°6

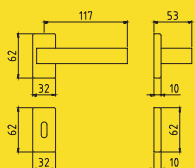

2 0006



Mont. n°75



Per istruzioni di montaggio scansiona QR code, seleziona il numero di riferimento e segui le istruzioni.  
For assembly instructions scan the QR code, select the relevant assembly number and follow the instructions.

# IDEA

66092

Idea

Zamak



ZCL



ZNS



ZCS



ZCL

Handles

	ZCL	ZCS	ZNS	Conf. Pz.
1 Q8 R Guarnitura Q8 ros. senza bocc. Lever handle 8mm on rose	66092280507	66092280513	66092280527	1
1 Q8 RB Guarnitura Q8 ros./bocc. patent Lever handle 8mm on rose key hole escutcheon	66092281507	66092281513	66092281527	1
1 Q8 RBY Guarnitura Q8 ros./bocc. yale Lever handle 8mm on rose - cyl. hole escutcheon	66092285507	66092285513	66092285527	1
1 Q8 RBWC Guarnitura Q8 ros./bocc. Wc Lever handle 8mm on rose wc hole escutcheon	66092288007	66092288013	66092288027	1
2 Q8 ROC Guarnitura Q8 ros.ovale senza bocc. Lever handle 8mm on oval rose	66092220507	66092220513	66092220527	1
2 Q8 RBOC Guarnitura Q8 ros/boc. ovale patent Lever handle 8mm on oval rose key hole escutcheon	66092221507	66092221513	66092221527	1
2 Q8 RBOYC Guarnitura Q8 ros/boc. ovale Yale Lever handle 8mm on oval rose - cyl. hole escutcheon	66092225507	66092225513	66092225527	1
3 EZ Cremonese gioco EZ Mechanism for window handle spindle 7 mm	66094406007	66094406013	66094406027	2
3 EZQ7 Cremonese gioco EZ + Q7 Mechanism for window handle spindle 7 mm	66094407007	66094407013	66094407027	2
3 MART Martellina Q7 window handle	66094500007	66094500013	66094500027	2
4 DK x 40-35 Martellina DK Q7 x 40-35 window handle DK x 40-35mm	66092577007	66092577013	66092577027	2
4 DK x 40-35 C/BUSS Martellina DK Q7 x 40-35 con bussole window handle DK x 40-35 mm with pins D.9.5	66092578007	66092578013	66092578027	2

66092

Idea

## PORTA

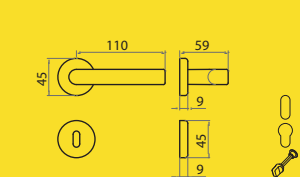

1 Ros 45x9



## FINESTRA

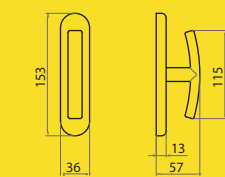

3

Mont. n°142-143

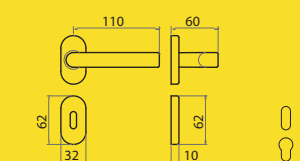

2 Ros 0006

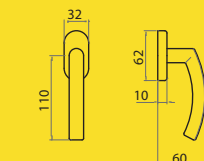
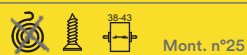

4



Per istruzioni di montaggio  
scansiona QR code,  
seleziona il numero di  
riferimento e segui le  
istruzioni.  
For assembly instructions  
scan the QR code, select the  
relevant assembly number  
and follow the instructions.

Zama

Maniglie

# IDEA Q

66080

Idea Q

Zamak



ZCL



ZNS



ZCS

Handles

	ZCL	ZCS	ZNS	Conf. Pz.
1 Q8 RQ Guarnitura Q8 ros. senza bocc. Lever handle 8mm on rose	66080280507	66080280513	66080280527	1
1 Q8 RBQ Guarnitura Q8 ros./bocc. patent Lever handle 8mm on rose key hole escutcheon	66080281507	66080281513	66080281527	1
1 Q8 RBQY Guarnitura Q8 ros./bocc. yale Lever handle 8mm on rose - cyl. hole escutcheon	66080285507	66080285513	66080285527	1
1 Q8 RBQWC Guarnitura Q8 ros./bocc. Wc Lever handle 8mm on rose wc hole escutcheon	66080288007	66080288013	66080288027	1
2 Q8 RRC guarnitura rosetta rettangolare Q8 C/M molla dx/sx Lever handle 8mm on springloaded rectangular rose	66080210407	66080210413	66080210427	1
2 Q8 RBR Guarnitura Q8 ros./bocc. rett. patent molla dx/sx Lever handle 8mm on springloaded rect rose key hole esc	66080211407	66080211413	66080211427	1
2 Q8 RBYR Guarnitura Q8 ros./bocc. rett.yale molla dx/sx Lever handle 8mm on springloaded rect rose - cyl. hole esc	66080215407	66080215413	66080215427	1
3 DK x 40-35 Martellina DK Q7 x 40-35 window handle DK x 40-35mm	66080577007	66080577013	66080577027	2
3 DK x 40-35 C/BUSS Martellina DK Q7 x 40-35 con bussole window handle DK x 40-35 mm with pins D.9.5	66080578007	66080578013	66080578027	2

66080

Idea Q

## PORTA

## FINESTRA

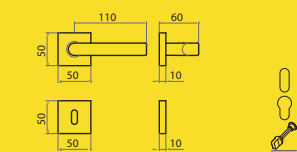

1 Ros 574

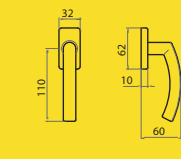

3

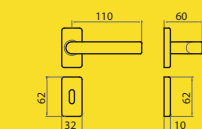
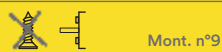

2



Per istruzioni di montaggio  
scansiona QR code,  
seleziona il numero di  
riferimento e segui le  
istruzioni.  
For assembly instructions  
scan the QR code, select the  
relevant assembly number  
and follow the instructions.

Zama

Maniglie

# LEAF

DESIGN MESSINEO E SETTIMELLI

66505

Leaf

Zamak



ZCL



ZCS



ZNO



ZCS

Handles



	ZCL	ZCS	ZNO	Conf. Pz.
1 Q8 R Guarnitura Q8 ros. senza bocc. Lever handle 8mm on rose	66505240707	66505240713	66505240716	1
1 Q8 RB Guarnitura Q8 ros./bocc. patent Lever handle 8mm on rose key hole escutcheon	66505241707	66505241713	66505241716	1
1 Q8 RBY Guarnitura Q8 ros./bocc. yale Lever handle 8mm on rose - cyl. hole escutcheon	66505245707	66505245713	66505245716	1
1 Q8 RBWC Guarnitura Q8 ros./bocc. Wc Lever handle 8mm on rose - wc 6mm function	66505248707	66505248713	66505248716	1
2 Q8 RBOC Guarnitura ros./bocc. ovale patent molla dx/sx Lever handle 8mm on springloaded oval rose key hole escutcheon	66505221507	66505221513	66505221516	1
2 Q8 RBOYC Guarnitura Q8 ros./boc. ovale yale molla dx/sx Lever handle 8mm on springloaded oval rose - cyl. hole escutcheon	66505225507	66505225513	66505225516	1
3 DK X 40 C/BUSS Martellina DK Q7 x 40 con bussole D. 9,5 gioco in ferro window handle DK x 40mm with pins D.9,5 iron mechanism	66505549507	66505549513	66505549516	2
4 DK X 40 ribassato Martellina DK Q7 x 40 ribassato window handle DK x 40 mm thin mechanism	66505596007	66505596013	66505596016	2

⚡ Servizio G48: Articolo a magazzino e disponibile entro 48 dall'elaborazione dell'ordine. In base a disponibilita' e condizioni di vendita.  
G48 service: Item in stock and available within 48 hours of order processing. Based on availability and sales conditions.

## PORTA

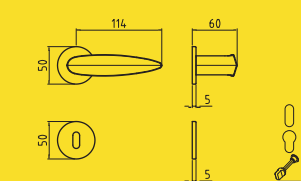

1 Ros ribassata  
(molla dx e sx - maniglia non solidale)



Mont. n°91-92

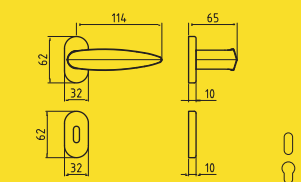

2 Ros 0006



Mont. n°23

## FINESTRA

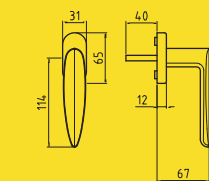

3 Gioco in ferro



Mont. n°4

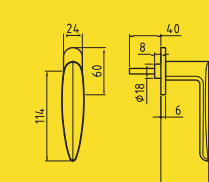

4



Mont. n°5



Per istruzioni di montaggio  
scansiona QR code,  
seleziona il numero di  
riferimento e segui le  
istruzioni.  
For assembly instructions  
scan the QR code, select the  
relevant assembly number  
and follow the instructions.

# LITZ

DESIGN MESSINEO E SETTIMELLI

66500

Litz

Zamak



ZCL



ZCS



ZNO



ZCS

Handles

	ZCL	ZCS	ZNO	Conf. Pz.
1 Q8 R Guarnitura Q8 ros. senza bocc. Lever handle 8mm on rose	66500240707	66500240713	66500240716	1
1 Q8 RB Guarnitura Q8 ros./bocc. patent Lever handle 8mm on rose key hole escutcheon	66500241707	66500241713	66500241716	1
1 Q8 RBY Guarnitura Q8 ros./bocc. yale Lever handle 8mm on rose - cyl. hole escutcheon	66500245707	66500245713	66500245716	1
1 Q8 RBWC Guarnitura Q8 ros./bocc. Wc Lever handle 8mm on rose - wc 6mm function	66500248707	66500248713	66500248716	1
2 Q8 RBOC Guarnitura ros./bocc. ovale patent molla dx/sx Lever handle 8mm on springloaded oval rose key hole escutcheon	66500221507	66500221513	66500221516	1
2 Q8 RBOYC Guarnitura Q8 ros./boc. ovale yale molla dx/sx Lever handle 8mm on springloaded oval rose - cyl. hole escutcheon	66500225507	66500225513	66500225516	1
3 DK X 40 C/BUSS Martellina DK Q7 x 40 con bussole D. 9,5 gioco in ferro window handle DK x 40mm with pins D.9,5 iron mechanism	66500549507	66500549513	66500549516	2
4 DK X 40 ribassato Martellina DK Q7 x 40 ribassato window handle DK x 40 mm thin mechanism	66500596007	66500596013	66500596016	2

⚡ Servizio G48: Articolo a magazzino e disponibile entro 48 dall'elaborazione dell'ordine. In base a disponibilita' e condizioni di vendita.  
G48 service: Item in stock and available within 48 hours of order processing. Based on availability and sales conditions.

## PORTA

## FINESTRA

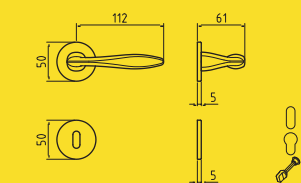

1 Ros ribassata  
(molla dx e sx - maniglia non solidale)



Mont. n°91-92

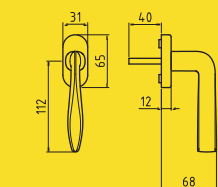

3 Gioco in ferro

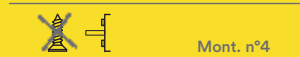

Mont. n°4

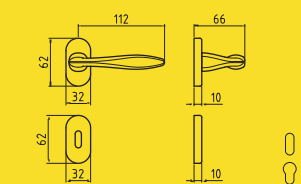

2 Ros 0006

Mont. n°23

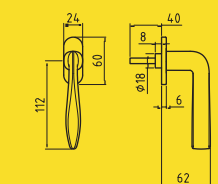

4

Mont. n°5



Per istruzioni di montaggio  
scansiona QR code,  
seleziona il numero di  
riferimento e segui le  
istruzioni.  
For assembly instructions  
scan the QR code, select the  
relevant assembly number  
and follow the instructions.

# MILENA Z

66744

Milena Z

Zamak



ZCL



ZCS



GCTOL



GCTOL

Handles

		ZCS	ZCS/F1-SAT	GCTOL	ZCL	Conf. Pz.
1	Q8 P90 Guarnitura Q8 placca patent 90 Lever handle 8mm on key plate 90	66744089013		66744089012	66744089007	1
1	Q8 P70 Guarnitura Q8 placca patent 70 Lever handle 8mm on key plate 70	66744087013		66744087012	66744087007	1
1	Q8 PY85 Guarnitura Q8 placca yale 85 Lever handle 8mm on cyl. plate 85	66744088513		66744088512	66744088507	1
2	Q8 R Guarnitura Q8 ros./bocc. Lever handle 8mm on rose	66744280513	66746280513	66744280512	66744280507	1
2	Q8 RB Guarnitura Q8 ros./bocc. patent Lever handle 8mm on rose key hole escutcheon	66744281513	66746281513	66744281512	66744281507	1
2	Q8 RBY Guarnitura Q8 ros./bocc. yale Lever handle 8mm on rose - cyl. hole escutcheon	66744285513	66746285513	66744285512	66744285507	1
2	Q8 RBWC Guarnitura Q8 ros./bocc. Wc Lever handle 8mm on rose wc hole escutcheon	66744288013	66746288513	66744288012	66744288007	1
3	DK X 40 Martellina DK Q7 x 40 window handle DK x 40 mm	66744557013		66744557012	66744557007	2
3	DK X 40 C/BUSS. Martellina DK Q7 x 40 con bussole D. 9,5 window handle DK x 40mm with pins D.9,5	66744558013		66744558012	66744558007	2

⚡ Servizio G48: Articolo a magazzino e disponibile entro 48 dall'elaborazione dell'ordine. In base a disponibilita' e condizioni di vendita.  
G48 service: Item in stock and available within 48 hours of order processing. Based on availability and sales conditions.

## PORTA

## FINESTRA

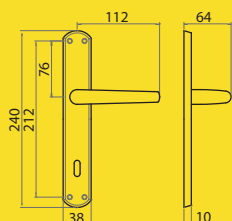

1 Placca MILENA

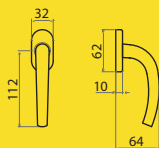

3

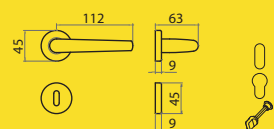
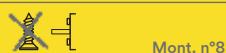

2 Ros 45x9



Per istruzioni di montaggio scansiona QR code, seleziona il numero di riferimento e segui le istruzioni.  
For assembly instructions scan the QR code, select the relevant assembly number and follow the instructions.

# NION

R0754

Nion

Zamak



Z-OSO



Z-BGO



ZCS



ZNO

Handles



ZCS

	ZCS	ZNO	Z-BGO	Z-OSO	Conf. Pz.
1 Q8 RB Guarnitura Q8 ros./bocc. patent Lever handle 8mm on rose key hole escutcheon	R0754241713	R0754241716	R0754241764	R0754241766	1
1 Q8 RBY Guarnitura Q8 ros./bocc. yale Lever handle 8mm on rose - cyl. hole escutcheon	R0754245713	R0754245716	R0754245764	R0754245766	1
1 Q8 RBWC Guarnitura Q8 ros./bocc. Wc Lever handle 8mm on rose - wc 6mm function	R0754248713	R0754248716	R0754248764	R0754248766	1
2 DK X 40 ribassato Martellina DK Q7 x 40 ribassato window handle DK x 40 mm thin mechanism	R0754596013	R0754596016	R0754596064	R0754596066	2
3 DK X 40 C/BUSS Martellina DK Q7 x 40 con bussole D. 9,5 gioco in ferro window handle DK x 40mm with pins D.9,5 iron mechanism	R075400048213	R075400048216	R075400048264	R075400048266	2

⚡ Servizio G48: Articolo a magazzino e disponibile entro 48 dall'elaborazione dell'ordine. In base a disponibilita' e condizioni di vendita.  
G48 service: Item in stock and available within 48 hours of order processing. Based on availability and sales conditions.

R0754

Nion

## PORTA

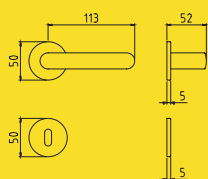

- 1 Ros ribassata  
(molla dx e sx - maniglia non solidale)



Mont. n°91-92

## FINESTRA

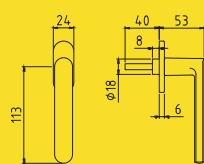

2



Mont. n°5

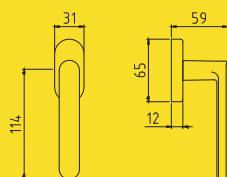

3



Mont. n°4



Per istruzioni di montaggio  
scansiona QR code,  
seleziona il numero di  
riferimento e segui le  
istruzioni.  
For assembly instructions  
scan the QR code, select the  
relevant assembly number  
and follow the instructions.

Zama

Maniglie



# NION Q

R0754

Nion Q

Zamak



Z-OSO



Z-BGO



ZCS



ZNO



ZCS

Handles

	ZCS	ZNO	Z-BGO	Z-OSO	Conf. Pz.
1 Q8 RBQ Guarnitura Q8 ros./bocc. patent Lever handle 8mm on rose key hole escutcheon	R0754241813	R0754241816	R0754241864	R0754241866	1
1 Q8 RBQY Guarnitura Q8 ros./bocc. yale Lever handle 8mm on rose - cyl. hole escutcheon	R0754245813	R0754245816	R0754245864	R0754245866	1
1 Q8 RBQWC Guarnitura Q8 ros./bocc. Wc Lever handle 8mm on rose wc hole escutcheon	R0754248813	R0754248816	R0754248864	R0754248866	1
2 DK X 40 ribassato Martellina DK Q7 x 40 ribassato window handle DK x 40 mm thin mechanism	R0754594013	R0754594016	R0754594064	R0754594066	2
3 DK X 40 C/BUSS Martellina DK Q7 x 40 con bussole D. 9,5 gioco in ferro window handle DK x 40mm with pins D.9,5 iron mechanism	R075400C48213	R075400C48216	R075400C48264	R075400C48266	2

⚡ Servizio G48: Articolo a magazzino e disponibile entro 48 dall'elaborazione dell'ordine. In base a disponibilita' e condizioni di vendita.  
G48 service: Item in stock and available within 48 hours of order processing. Based on availability and sales conditions.

R0754

Nion Q

## PORTA

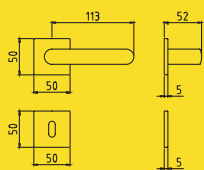

- 1 Ros ribassata  
(molla dx e sx - maniglia non solidale)



Mont. n°66-67

## FINESTRA

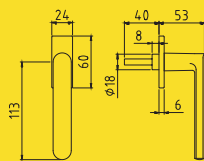

2



Mont. n°7

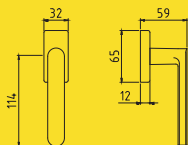

3



Mont. n°6



Per istruzioni di montaggio  
scansiona QR code,  
seleziona il numero di  
riferimento e segui le  
istruzioni.  
For assembly instructions  
scan the QR code, select the  
relevant assembly number  
and follow the instructions.

Zama

Maniglie

# R938

R0938

R938

Zamak



OCS



OLV



OCL



ONS



OCS



OCS

Handles

	ZCL	GCTOL	ZCS	ZNS	Conf Pz.
1 Q8 R Guarnitura Q8 ros. senza bocc. Lever handle 8mm on rose	R09380005050760	R09380005051260	R09380005051360	R09380005052760	1
1 Q8 RB Guarnitura Q8 ros./bocc. BB Lever handle 8mm on rose - key escutcheon	R09380005120760	R09380005121260	R09380005121360	R09380005122760	1
1 Q8 RB Guarnitura Q8 ros./bocc. patent Lever handle 8mm on rose - key escutcheon	R09380005100760	R09380005101260	R09380005101360	R09380005102760	1
1 Q8 RBY Guarnitura Q8 ros./bocc. yale Lever handle 8mm on rose - cyl. hole escutcheon	R09380005500760	R09380005501260	R09380005501360	R09380005502760	1
1 Q8 RBWC Guarnitura Q8 ros./bocc. Wc Lever handle 8mm on rose - wc 6mm function	R09380005880760	R09380005881260	R09380005881360	R09380005882760	1
2 DK x 35 C/BUSS. Martellina DK Q7x35 c/bussole D.9,5 mm viti metriche window handle DK x 35 mm with pins D.9,5 metric screws	R09380004800790	R09380004801290	R09380004801390	R09380004802790	1
3 DK x 42 C/CHIAVE C/BUSS. Martellina con chiave DK Q7x42 c/bus D.9,5 mm viti metriche window handle DK x 42mm with key / pins D.9,5 with screws	R093800A4840790	R093800A4841290	R093800A4841390	R093800A4842790	1

R0938

R938

## PORTA

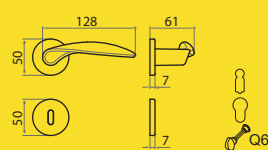

- 1 Ros 0005 On request
- 
- Mont. n°33

## FINESTRA

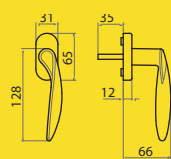

- 2 DK 45 Gioco in ferro
- 
- Mont. n°4

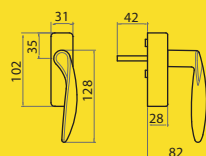

- 3 RG Mont. n°11
- 



Per istruzioni di montaggio  
scansiona QR code,  
seleziona il numero di  
riferimento e segui le  
istruzioni.  
For assembly instructions  
scan the QR code, select the  
relevant assembly number  
and follow the instructions.

Zama

Maniglie

# RIALTO

DESIGN MESSINEO E SETTIMELLI

66515

Rialto

Zamak



ZCL



ZCS



ZNO



ZCS

Handles

	ZCL	ZCS	ZNO	Conf. Pz.
1 Q8 RQ Guarnitura Q8 ros. senza bocc. Lever handle 8mm on rose	66515240807	66515240813	66515240816	1
1 Q8 RBQ Guarnitura Q8 ros./bocc. patent Lever handle 8mm on rose key hole escutcheon	66515241807	66515241813	66515241816	1
1 Q8 RBQY Guarnitura Q8 ros./bocc. yale Lever handle 8mm on rose - cyl. hole escutcheon	66515245807	66515245813	66515245816	1
1 Q8 RBQWC Guarnitura Q8 ros./bocc. Wc Lever handle 8mm on rose wc hole escutcheon	66515248807	66515248813	66515248816	1
2 Q8 RBR Guarnitura Q8 ros./bocc. rett. patent molla dx/sx Lever handle 8mm on springloaded rect rose key hole esc	66515211407	66515211413	66515211416	1
2 Q8 RBRY Guarnitura Q8 ros./bocc. rett.yale molla dx/sx Lever handle 8mm on springloaded rect rose cylinder hole esc	66515215407	66515215413	66515215416	1
3 DK X 40 C/BUSS Martellina DK Q7 x 40 con bussole D. 9,5 gioco in ferro window handle DK x 40mm with pins D.9,5 iron mechanism	66515553807	66515553813	66515553816	2
4 DK X 40 ribassato Martellina DK Q7 x 40 ribassato window handle DK x 40 mm thin mechanism	66515594007	66515594013	66515594016	2

⚡ Servizio G48: Articolo a magazzino e disponibile entro 48 dall'elaborazione dell'ordine. In base a disponibilita' e condizioni di vendita.  
G48 service: Item in stock and available within 48 hours of order processing. Based on availability and sales conditions.

## PORTA

## FINESTRA

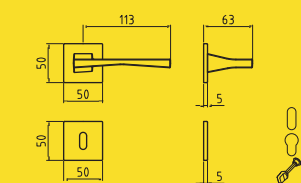

1 Ros 50x50x5  
(molla dx e sx - maniglia non solidale)

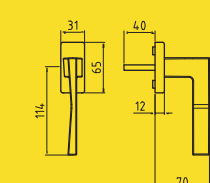

3 Gioco in ferro

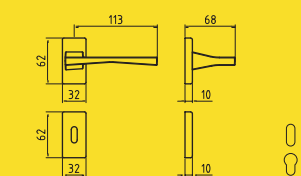
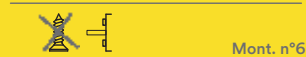

2 Ros 0006

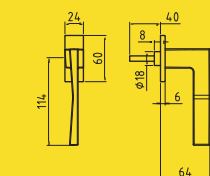

4

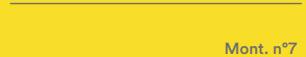

Per istruzioni di montaggio  
scansiona QR code,  
seleziona il numero di  
riferimento e segui le  
istruzioni.  
For assembly instructions  
scan the QR code, select the  
relevant assembly number  
and follow the instructions.

# SEVEN

66470

Seven

Zamak



ZCL



GCTOL



ZCS



ZNS



ZCS

Handles

	ZCL	GCTOL	ZCS	ZNS	Conf. Pz.
1 Q8 RT Guarnitura Q8 ros. senza bocc. Lever handle 8mm on rose	66470280907	66470280912	66470280913	66470280927	1
1 Q8 RBT Guarnitura Q8 ros./bocc. patent Lever handle 8mm on rose key hole escutcheon	66470281907	66470281912	66470281913	66470281927	1
1 Q8 RBYT Guarnitura Q8 ros./bocc. yale Lever handle 8mm on rose - cyl. hole escutcheon	66470285907	66470285912	66470285913	66470285927	1
1 Q8 RBTWC Guarnitura Q8 ros./bocc. WC Q6 Lever handle 8mm on rose - wc 6mm function	66470288907	66470288912	66470288913	66470288927	1
2 Q8 ROC Guarnitura Q8 ros.ovale senza bocc.molla dx/sx Lever handle 8mm on springloaded oval rose	66470220607	66470220612	66470220613	66470220627	1
2 Q8 RBOC Guarnitura ros./bocc. ovale patent molla dx/sx Lever handle 8mm on springloaded oval rose key hole escutcheon	66470221607	66470221612	66470221613	66470221627	1
2 Q8 RBOYC Guarnitura Q8 ros/bocc. ovale yale molla dx/sx Lever handle 8mm on springloaded oval rose - cyl. hole escutcheon	66470225607	66470225612	66470225613	66470225627	1
3 DK x 40 Martellina DK Q7x40 window handle DK x 40 mm	66470557007	66470557012	66470557013	66470557027	2
3 DK X 40 C/BUSS. Martellina DK Q7 x 40 con bussole D.9,5 mm window handle DK x 40mm with pins D.9,5	66470558007	66470558012	66470558013	66470558027	2

66470

Seven

## PORTA

## FINESTRA

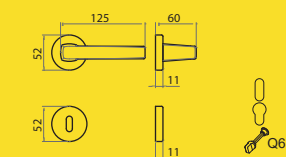

1 Ros 575

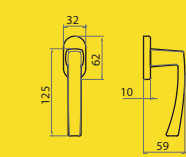

3

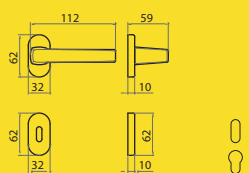
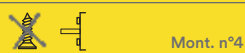

2 Ros 0006



Per istruzioni di montaggio  
scansiona QR code,  
seleziona il numero di  
riferimento e segui le  
istruzioni.  
For assembly instructions  
scan the QR code, select the  
relevant assembly number  
and follow the instructions.

Zama

Maniglie



# SEVEN Q

66470

Seven Q

Zamak



ZCL



GCTOL



ZNS



ZCS



ZCS

Handles

	ZCL	GCTOL	ZCS	ZNS	Conf. Pz.
1 Q8 RQ Guarnitura Q8 ros. senza bocc. Lever handle 8mm on rose	66470210307	66470210312	66470210313	66470210327	1
1 Q8 RBQ Guarnitura Q8 ros./bocc. patent Lever handle 8mm on rose key hole escutcheon	66470211307	66470211312	66470211313	66470211327	1
1 Q8 RBQY Guarnitura Q8 ros./bocc. yale Lever handle 8mm on rose - cyl. hole escutcheon	66470215307	66470215312	66470215313	66470215327	1
1 Q8 RBQWC Guarnitura Q8 ros./bocc. Wc Lever handle 8mm on rose wc hole escutcheon	66470218307	66470218312	66470218313	66470218327	1
2 Q8 RRC guarnitura rosetta rettangolare Q8 C/M molla dx/sx Lever handle 8mm on springloaded rectangular rose	66470210407	66470210412	66470210413	66470210427	1
2 Q8 RBR Guarnitura Q8 ros./bocc. rett. patent molla dx/sx Lever handle 8mm on springloaded rect rose key hole esc	66470211407	66470211412	66470211413	66470211427	1
2 Q8 RBYR Guarnitura Q8 ros./bocc. rett. yale molla dx/sx Lever handle 8mm on springloaded rect rose - cyl. hole esc	66470215407	66470215412	66470215413	66470215427	1
3 DK x 40 Martellina DK Q7 x 40 window handle DK x 40 mm	66470555007	66470555012	66470555013	66470555027	2
3 DK X 40 C/BUSS. Martellina DK Q7 x 40 con bussole D.9,5 mm window handle DK x 40mm with pins D.9,5	66470556007	66470556012	66470556013	66470556027	2

66470

Seven Q

## PORTA

## FINESTRA

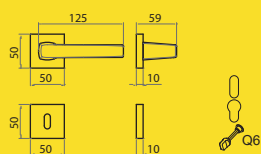

1 Ros 574

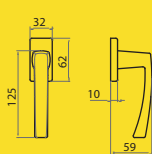
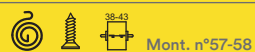

3

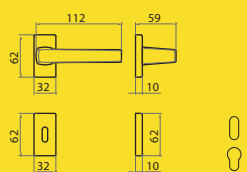
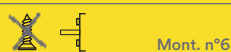

2 Ros 00C6



Per istruzioni di montaggio  
scansiona QR code,  
seleziona il numero di  
riferimento e segui le  
istruzioni.  
For assembly instructions  
scan the QR code, select the  
relevant assembly number  
and follow the instructions.

Zama

Maniglie

# SHARK

66480

Shark

Zamak



ZCS



ZCL



GCTOL



ZNS



ZCS



ZCS



ZCS



ZCS

Handles

	ZCS	ZCS/F1-SAT	GCTOL	ZCL	ZNS	Conf. Pz.
1 Q8 P70 Guarnitura Q8 placca patent 70 Lever handle 8mm on plate key hole 70 mm	66480087013		66480087012	66480087007	66480087027	1
1 Q8 PY85 Guarnitura Q8 placca Yale 85 Lever handle 8mm on cylinder plate 85 mm	66480088513		66480088512	66480088507	66480088527	1
1 Q8 P90 Guarnitura Q8 placca P90 Lever handle 8mm on plate key hole 90 mm	66480089013		66480089012	66480089007	66480089027	1
2 Q8 R Guarnitura Q8 ros. senza bocc. Lever handle 8mm on rose	66480230513		66480230512	66480230507	66480230527	1
2 Q8 RB Guarnitura Q8 ros./bocc. patent Lever handle 8mm on rose key hole escutcheon	66480231513	66482231513	66480231512	66480231507	66480231527	1
2 Q8 RBY Guarnitura Q8 ros./bocc. yale Lever handle 8mm on rose - cyl. hole escutcheon	66480235513	66482235513	66480235512	66480235507	66480235527	1
2 Q8 RB50WC Guarnitura Q8 ros./bocc. WC Q6 Lever handle 8mm on rose - wc 6mm function	66480238613		66480238612	66480238607	66480238627	1
3 Q8 ROC Guarnitura Q8 ros.ovale senza bocc. Lever handle 8mm on oval rose	66480220513		66480220512	66480220507	66480220527	1
3 Q8 RBOC Guarnitura Q8 ros/boc. ovale patent Lever handle 8mm on oval rose key hole escutcheon	66480221513		66480221512	66480221507	66480221527	1
3 Q8 RBOYC Guarnitura Q8 ros/boc. ovale Yale Lever handle 8mm on oval rose - cyl. hole escutcheon	66480225513		66480225512	66480225507	66480225527	1
4 MART IM Martellina Q7 imp. Maniglia lever window handle	66480550013		66480550012	66480550007	66480550027	2
5 DK x 40 C/BUSS 4 scatti Martellina DK Q7 x 40 c/bussole D.9,5 window handle DK x 40 mm with pins D.9,5	66480549513		66480549512	66480549507	66480549527	2
5 DK x 40 C/BUSS 8 scatti Martellina DK Q7 x 40 c/bussole D.9,5 window handle DK x 40 mm with pins D.9,5	6648054951308		6648054951208	6648054950708	6648054952708	2
6 DK x 42 C/CHIAVE C/BUSS. Martellina con chiave DK Q7x42 c/bussole D.9,5 window handle DK x 42mm with key / pins D.9,5	66480563513		66480563512	66480563507	66480563527	1

## PORTA

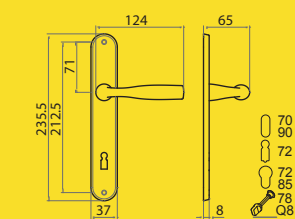

1 Placca ELBA

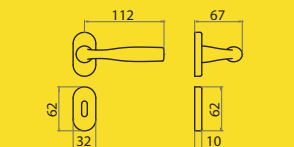

3



## FINESTRA

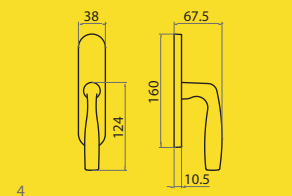

4

Mont. n°141

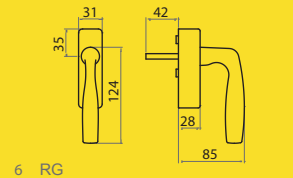

6

Mont. n°11

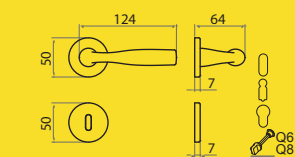

2 Ros 0005

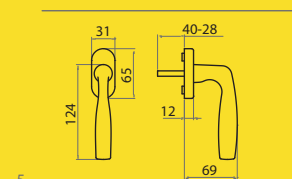

5

Gioco in ferro

Mont. n°4



Per istruzioni di montaggio scansiona QR code, seleziona il numero di riferimento e segui le istruzioni.  
For assembly instructions scan the QR code, select the relevant assembly number and follow the instructions.

# SWING

DESIGN FRANCESCO LUCCHESI

66410

Swing

Zamak



ZCL



ZCS



ZNO



ZCS

Handles

	ZCL	ZCS	ZNO	Conf. Pz.
1 Q8 RBQ Guarnitura Q8 ros./bocc. patent Lever handle 8mm on rose key hole escutcheon	66410241607	66410241613	66410241616	1
1 Q8 RBQY Guarnitura Q8 ros./bocc. yale Lever handle 8mm on rose - cyl. hole escutcheon	66410245607	66410245613	66410245616	1
1 Q8 RBQWC Guarnitura Q8 ros./bocc. Wc Lever handle 8mm on rose wc hole escutcheon	66410248607	66410248613	66410248616	1
2 DK X 40 Martellina DK Q7 x 40 window handle DK x 40 mm	66410555007	66410555013	66410555016	2
2 DK X 40 C/BUSS. Martellina DK Q7 x 40 con bussole D. 9,5 window handle DK x 40mm with pins D.9,5	66410556007	66410556013	66410556016	2

66410

Swing

## PORTA

## FINESTRA

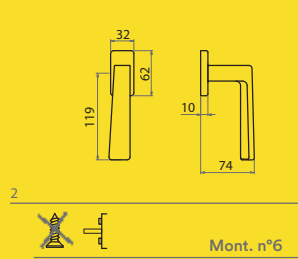
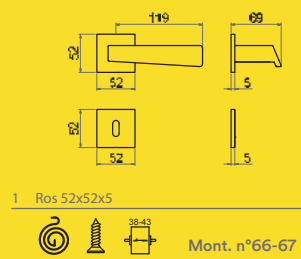

Zama



Per istruzioni di montaggio  
scansiona QR code,  
seleziona il numero di  
riferimento e segui le  
istruzioni.  
For assembly instructions  
scan the QR code, select the  
relevant assembly number  
and follow the instructions.

Maniglie

# TOY

R0753

Toy

Zamak



Z-OSO



Z-BGO



ZCS



ZNO

Handles



ZCS

		ZCS	ZNO	Z-BGO	Z-OSO	Conf. Pz.
1	Q8 RB Guarnitura Q8 ros./bocc. patent Lever handle 8mm on rose key hole - escutcheon	R0753241713	R0753241716	R0753241764	R0753241766	1
1	Q8 RBY Guarnitura Q8 ros./bocc. yale Lever handle 8mm on rose - cyl. hole escutcheon	R0753245713	R0753245716	R0753245764	R0753245766	1
1	Q8 RBWC Guarnitura Q8 ros./bocc. Wc Lever handle 8mm on rose - wc 6mm function	R0753248713	R0753248716	R0753248764	R0753248766	1
2	DK X 40 ribassato Martellina DK Q7 x 40 ribassato window handle DK x 40 mm thin mechanism	R0753596013	R0753596016	R0753596064	R0753596066	2
2	DK X 40 C/BUSS Martellina DK Q7 x 40 con bussole D. 9,5 gioco in ferro window handle DK x 40mm with pins D.9.5 iron mechanism	R075300048213	R075300048216	R075300048264	R075300048266	2

⚡ Servizio G48: Articolo a magazzino e disponibile entro 48 dall'elaborazione dell'ordine. In base a disponibilita' e condizioni di vendita.  
G48 service: Item in stock and available within 48 hours of order processing. Based on availability and sales conditions.

R0753

Toy

## PORTA

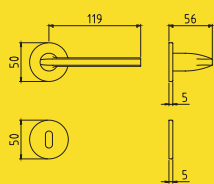

1 Ros ribassata  
(molla dx e sx - maniglia non solidale)

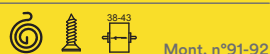

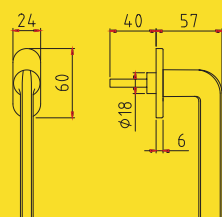

## FINESTRA

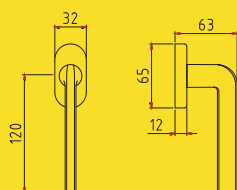

2    Mont. n°5



3    Mont. n°4



Per istruzioni di montaggio  
scansiona QR code,  
seleziona il numero di  
riferimento e segui le  
istruzioni.  
For assembly instructions  
scan the QR code, select the  
relevant assembly number  
and follow the instructions.

Zama

Maniglie



# TOY Q

R0753

Toy Q

Zamak



Z-OSO



Z-BGO



ZCS



ZNO

Handles



ZCS

	ZCS	ZNO	Z-BGO	Z-OSO	Conf. Pz.
1 Q8 RBQ Guarnitura Q8 ros./bocc. patent Lever handle 8mm on rose key hole escutcheon	R0753241813	R0753241816	R0753241864	R0753241866	1
1 Q8 RBQY Guarnitura Q8 ros./bocc. yale Lever handle 8mm on rose - cyl. hole escutcheon	R0753245813	R0753245816	R0753245864	R0753245866	1
1 Q8 RBQWC Guarnitura Q8 ros./bocc. Wc Lever handle 8mm on rose wc hole escutcheon	R0753248813	R0753248816	R0753248864	R0753248866	1
2 DK X 40 ribassato Martellina DK Q7 x 40 ribassato window handle DK x 40 mm thin mechanism	R0753594013	R0753594016	R0753594064	R0753594066	2
3 DK X 40 C/BUSS Martellina DK Q7 x 40 con bussole D. 9,5 gioco in ferro window handle DK x 40mm with pins D.9,5 iron mechanism	R075300C48213	R075300C48216	R075300C48264	R075300C48266	2

⚡ Servizio G48: Articolo a magazzino e disponibile entro 48 dall'elaborazione dell'ordine. In base a disponibilita' e condizioni di vendita.  
G48 service: Item in stock and available within 48 hours of order processing. Based on availability and sales conditions.

R0753

Toy Q

## PORTA

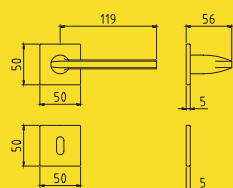

- 1 Ros ribassata  
(molla dx e sx - maniglia non solidale)



Mont. n°66-67

## FINESTRA

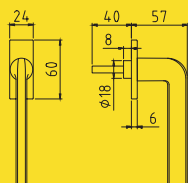

- 2
- 

Mont. n°7

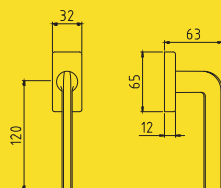

- 3
- 

Mont. n°6



Per istruzioni di montaggio  
scansiona QR code,  
seleziona il numero di  
riferimento e segui le  
istruzioni.  
For assembly instructions  
scan the QR code, select the  
relevant assembly number  
and follow the instructions.

Zama

Maniglie

# UNO Z

66546

Uno Z

Zamak

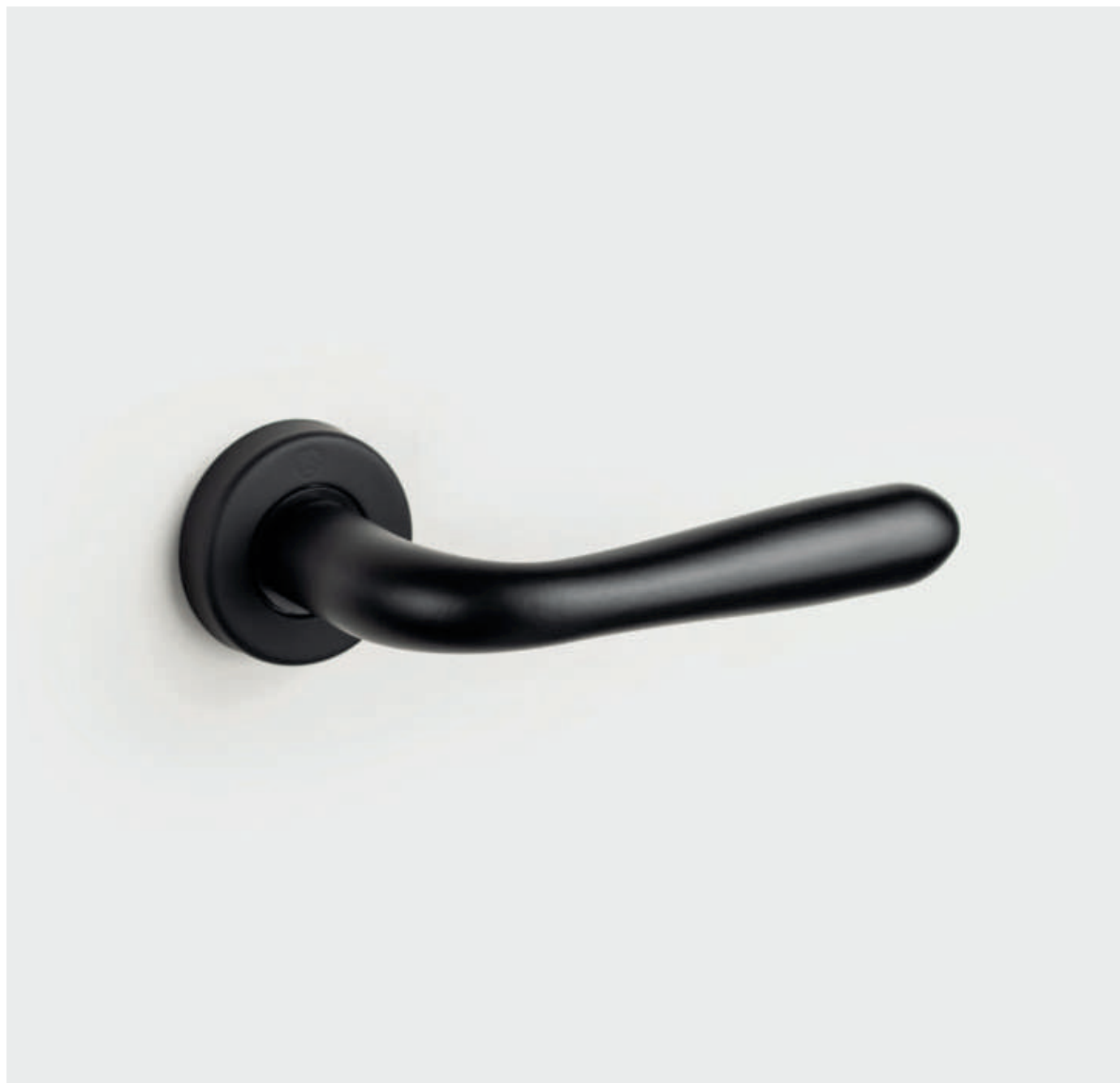

GCTOL



ZCL



ZCS



ZNS



ZNO



GCTOL



GCTOL

Handles

	ZCS	ZCS/F1-SAT	GCTOL	ZCL	ZNS	ZNO	Conf. Pz.
1 Q8 P90 Guarnitura Q8 placca patent 90 Lever handle 8mm on key plate 90	66546089013		66546089012	66546089007		66546089016	1
1 Q8 P70 Guarnitura Q8 placca patent 70 Lever handle 8mm on key plate 70	66546087013		66546087012	66546087007		66546087016	1
1 Q8 PY85 Guarnitura Q8 placca yale 85 Lever handle 8mm on cyl. plate 85	66546088513		66546088512	66546088507		66546088516	1
2 Q8 R Guarnitura Q8 ros. senza bocc. Lever handle 8mm on rose	66546280013	66547280013	66546280012	66546280007	66546280027	66546280016	1
2 Q8 RB Guarnitura Q8 ros./bocc. patent Lever handle 8mm on rose key hole escutcheon	66546281013	66547281013	66546281012	66546281007	66546281027	66546281016	1
2 Q8 RBY Guarnitura Q8 ros./bocc. yale Lever handle 8mm on rose - cyl. hole escutcheon	66546285013	66547285013	66546285012	66546285007	66546285027	66546285016	1
2 Q8 RBWC Guarnitura Q8 ros./bocc. Wc Lever handle 8mm on rose wc hole escutcheon	66546288013	66547288013	66546288012	66546288007	66546288027	66546288016	1
3 DK X 40 Martellina DK Q7 x 40 window handle DK x 40 mm	66546557013		66546557012	66546557007	66546557027	66546557016	2
3 DK X 40 C/BUSS. Martellina DK Q7 x 40 con bussole D. 9,5 window handle DK x 40mm with pins D.9,5	66546558013		66546558012	66546558007	66546558027	66546558016	2

⚡ Servizio G48: Articolo a magazzino e disponibile entro 48 dall'elaborazione dell'ordine. In base a disponibilita' e condizioni di vendita.  
G48 service: Item in stock and available within 48 hours of order processing. Based on availability and sales conditions.

## PORTA

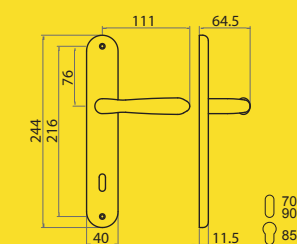

1 Placca UNO



## FINESTRA

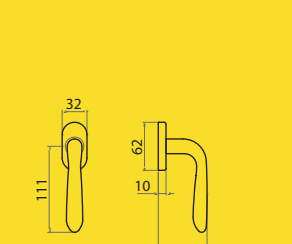

6

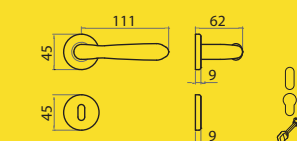
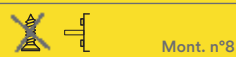

3 Ros 45X9



Per istruzioni di montaggio  
scansiona QR code,  
seleziona il numero di  
riferimento e segui le  
istruzioni.  
For assembly instructions  
scan the QR code, select the  
relevant assembly number  
and follow the instructions.

# VICTORIA

66246

Victoria

Zamak



ZGV



GCTOL



GCTOL



OLV

Handles

		GCTOL	OLV	ZGV	OGV	Conf. Pz.
1	Q8 P90 Guarnitura Q8 placca patent 90 Lever handle 8mm on key plate 90	66246089012		66246089004		1
1	Q8 P70 Guarnitura Q8 placca patent 70 Lever handle 8mm on key plate 70	66246087012		66246087004		1
1	Q8 PY85 Guarnitura Q8 placca yale 85 Lever handle 8mm on cyl. plate 85	66246088512		66246088504		1
2	Q8 P90RS Guarnitura Q8 placca stretta pat 90 Lever handle 8mm on reduced key plate 90	66246051012		66246051004		1
2	Q8 P70RS Guarnitura Q8 placca stretta pat 70 Lever handle 8mm on reduced key plate 70	66246057012		66246057004		1
2	Q8 PY85RS Guarnitura Q8 placca stretta yale 85 Lever handle 8mm on reduced cyl. plate 85	66246055012		66246055004		1
2	Q8 R Guarnitura Q8 ros. senza bocc. Lever handle 8mm on rose	66246280012		66246280004		1
3	Q8 RB Guarnitura Q8 ros./bocc. patent Lever handle 8mm on rose key hole escutcheon	66246281012	⚡	66246281004	⚡	1
3	Q8 RBY Guarnitura Q8 ros./bocc. yale Lever handle 8mm on rose - cyl. hole escutcheon	66246285012	⚡	66246285004	⚡	1
3	Q8 RBWC Guarnitura Q8 ros./bocc. Wc Lever handle 8mm on rose wc hole escutcheon	66246288012	⚡	66246288004	⚡	1
3	Q8 ROC Guarnitura Q8 ros.ovale senza bocc. Lever handle 8mm on oval rose	66246220512		66246220504		1
4	Q8 RBOC Guarnitura Q8 ros/boc. ovale patent Lever handle 8mm on oval rose key hole escutcheon	66246221512		66246221504		1
4	Q8 RBOYC Guarnitura Q8 ros/boc. ovale Yale Lever handle 8mm on oval rose - cyl. hole escutcheon	66246225512		66246225504		1
5	MART Martellina Q7 window handle		55010500001		55010500004	2
6	DK X 40 Martellina DK Q7 x 40 window handle DK x 40 mm	66246557012		66246557004		2
6	DK X 40 C/BUSS. Martellina DK Q7 x 40 con bussole D. 9,5 window handle DK x 40mm with pins D.9,5	66246558012		66246558004		2

⚡ Servizio G48: Articolo a magazzino e disponibile entro 48 dall'elaborazione dell'ordine. In base a disponibilita' e condizioni di vendita.  
G48 service: Item in stock and available within 48 hours of order processing. Based on availability and sales conditions.

## PORTA

## FINESTRA

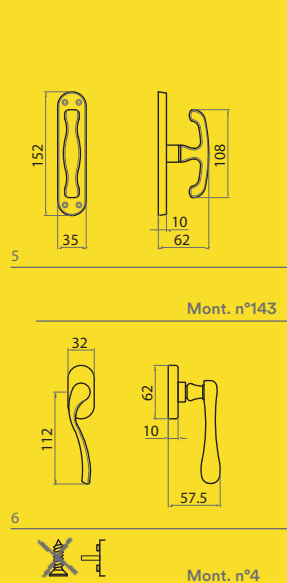
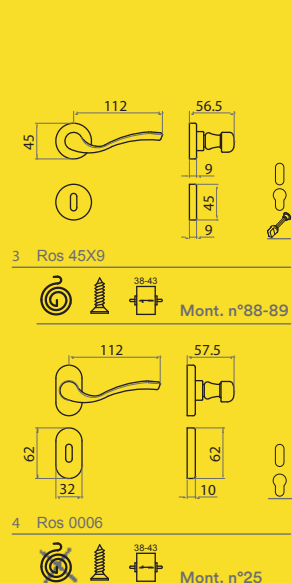
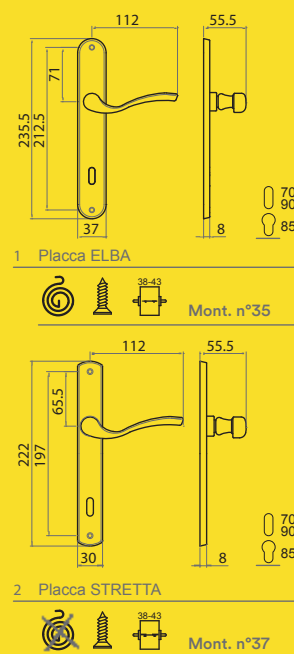

Per istruzioni di montaggio scansiona QR code, seleziona il numero di riferimento e segui le istruzioni.  
For assembly instructions scan the QR code, select the relevant assembly number and follow the instructions.

# WING

77792

Wing

Aluminum



ACS



ACL



ACL

Handles

	ACS	ACL	Conf. Pz.
1 Q8 RQ Guarnitura Q8 ros. senza bocc. Lever handle 8mm on rose	77792280013	77792280017	1
1 Q8 RBQ Guarnitura Q8 ros./bocc. patent Lever handle 8mm on rose key hole escutcheon	77792281013	77792281017	1
1 Q8 RBQY Guarnitura Q8 ros./bocc. yale Lever handle 8mm on rose - cyl. hole escutcheon	77792285013	77792285017	1
1 Q8 RBWCQ Guarnitura Q8 ros./bocc. Wc Lever handle 8mm on rose wc hole escutcheon	77792288013	77792288017	1
2 DK x 40 Martellina DK Q7 x 40 window handle DK x 40 mm	77792555013	77792555017	2
2 DK X 40 C/BUS Martellina DK Q7 x 40 con bussole D. 9,5 window handle DK x 40mm with pins D.9,5	77792556013	77792556017	2

77792

Wing

## PORTA

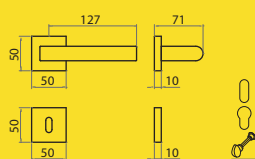

1 Ros 574



## FINESTRA

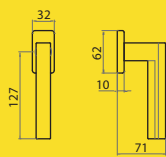

2

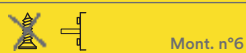

Alluminio



Per istruzioni di montaggio  
scansiona QR code,  
seleziona il numero di  
riferimento e segui le  
istruzioni.  
For assembly instructions  
scan the QR code, select the  
relevant assembly number  
and follow the instructions.

Maniglie



# YORK

66460

York

Zamak



ZCL



ZNS



ZCS

Handles

	ZCL	ZCS	ZNS	Conf. Pz.
1 Q8 RT Guarnitura Q8 ros. Senza bocc. Lever handle 8mm on rose	66460280907	66460280913	66460280927	1
1 Q8 RBT Guarnitura Q8 ros./bocc. patent Lever handle 8mm on rose key hole escutcheon	66460281907	66460281913	66460281927	1
1 Q8 RBTY Guarnitura Q8 ros./bocc. yale Lever handle 8mm on rose - cyl. hole escutcheon	66460285907	66460285913	66460285927	1
1 Q8 RBTWC Guarnitura Q8 ros./bocc. Wc Lever handle 8mm on rose wc hole escutcheon	66460288907	66460288913	66460288927	1
2 Q8 ROC Guarnitura Q8 ros.ovale senza bocc.molla dx/sx Lever handle 8mm on springloaded oval rose	66460220607	66460220613	66460220627	1
2 Q8 RBOC Guarnitura Q8 ros./bocc. patent Lever handle 8mm on rose key hole escutcheon	66460221607	66460221613	66460221627	1
2 Q8 RBOYC Guarnitura Q8 ros./bocc. yale Lever handle 8mm on rose - cyl. hole escutcheon	66460225607	66460225613	66460225627	1
3 DK X 40 Martellina DK Q7 x 40 window handle DK x 40 mm	66460567007	66460567013	66460567027	2
3 DK X 40 C/BUSS. Martellina DK Q7 x 40 con bussole D. 9,5 window handle DK x 40mm with pins D.9,5	66460568007	66460568013	66460568027	2

66460

York

## PORTA

## FINESTRA

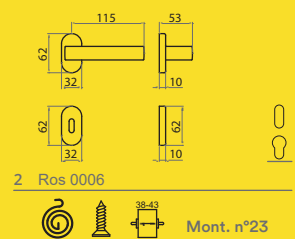
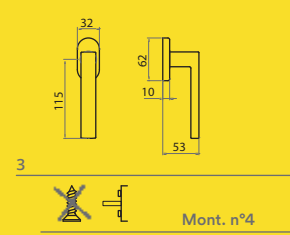
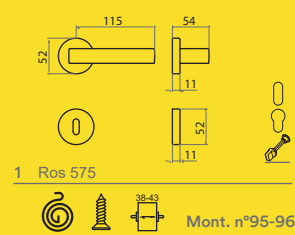

Per istruzioni di montaggio  
scansiona QR code,  
seleziona il numero di  
riferimento e segui le  
istruzioni.  
For assembly instructions  
scan the QR code, select the  
relevant assembly number  
and follow the instructions.

Zama

Maniglie

# YORK 4

66460

York 4

Zamak



ZCS



ZCL

	ZCL	ZCS	ZNO	RAL9010-opaco	Conf. Pz.
1 Q8 RQ 50x50x5 Guarnitura Q8 ros. senza bocc. Lever handle 8mm on rose	66460240607	66460240613	66460240616	66460240663	1
1 Q8 RBQ 50x50x5 Guarnitura Q8 ros./bocc. patent Lever handle 8mm on rose key hole escutcheon	66460241607	66460241613	66460241616	66460241663	1
1 Q8 RBQY 50x50x5 Guarnitura Q8 ros./bocc. yale Lever handle 8mm on rose - cyl. hole escutcheon	66460245607	66460245613	66460245616	66460245663	1
1 Q8 RBQWC 50x50x5 Guarnitura Q8 ros./bocc. Wc Lever handle 8mm on rose wc hole escutcheon	66460248607	66460248613	66460248616	66460248663	1

⚡ Servizio G48: Articolo a magazzino e disponibile entro 48 dall'elaborazione dell'ordine. In base a disponibilita' e condizioni di vendita.  
G48 service: Item in stock and available within 48 hours of order processing. Based on availability and sales conditions.

66460

York 4

## PORTA

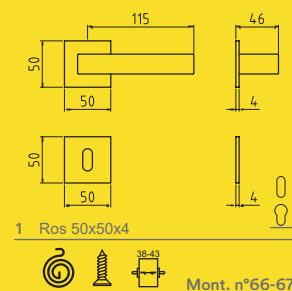

Zama



Per istruzioni di montaggio  
scansiona QR code,  
seleziona il numero di  
riferimento e segui le  
istruzioni.  
For assembly instructions  
scan the QR code, select the  
relevant assembly number  
and follow the instructions.

Maniglie

# YORK BERRY

66460

York Berry

Zamak



BERRY LORENA



BERRY NORMANDIA



BERRY BORGOGNA



BERRY CHAMPAGNE



BERRY CHAMPAGNE

Handles

	CHAMPAGNE	NORMANDIA	LORENA	BORGOGNA	Conf. Pz.
1 Q8 RQ Guarnitura Q8 ros. senza bocc. Lever handle 8mm on rose	664600544054360	664600544054460	664600544054660	664600544054760	1
1 Q8 RBQ Guarnitura Q8 ros./bocc. patent Lever handle 8mm on rose key hole escutcheon	664600544104360	664600544104460	664600544104660	664600544104760	1
1 Q8 RBQY Guarnitura Q8 ros./bocc. yale Lever handle 8mm on rose - cyl. hole escutcheon	664600544504360	664600544504460	664600544504660	664600544504760	1
1 Q8 RBQWC Guarnitura Q8 ros./bocc. Wc Lever handle 8mm on rose wc hole escutcheon	664600544884360	664600544884460	664600544884660	664600544884760	1
2 Q8 RRC guarnitura rosetta rettangolare Q8 C/M molla dx/sx Lever handle 8mm on springloaded rectangular rose	66460210443	66460210444	66460210446	66460210447	1
2 Q8 RBR Guarnitura Q8 ros./bocc. rett. patent molla dx/sx Lever handle 8mm on springloaded rect rose key hole esc	66460211443	66460211444	66460211446	66460211447	1
2 Q8 RBYR Guarnitura Q8 ros./bocc. rett.yale molla dx/sx Lever handle 8mm on springloaded rect rose - cyl. hole esc	66460215443	66460215444	66460215446	66460215447	1
3 DK X 40 Martellina DK Q7 x 40 window handle DK x 40 mm	66460557043	66460557044	66460557046	66460557047	2
3 DK X 40 C/BUSS. Martellina DK Q7 x 40 con bussole D. 9,5 window handle DK x 40mm with pins D.9,5	66460558043	66460558044	66460558046	66460558047	2

## PORTA

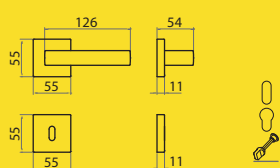

1 Ros 544



## FINESTRA

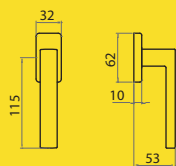

3

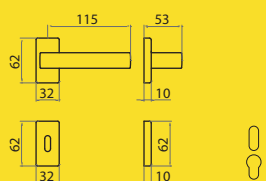

2 0006

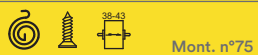

Per istruzioni di montaggio  
scansiona QR code,  
seleziona il numero di  
riferimento e segui le  
istruzioni.  
For assembly instructions  
scan the QR code, select the  
relevant assembly number  
and follow the instructions.

# YORK Q

66460

York Q

Zamak



ZCL



ZNS



ZNO



ZCS

Handles

	ZCL	ZCS	ZNO	ZNS	Conf. Pz.
1 Q8 RQ Guarnitura Q8 ros. senza bocc. Lever handle 8mm on rose	66460280007	66460280013	66460280016	66460280027	1
1 Q8 RBQ Guarnitura Q8 ros./bocc. patent Lever handle 8mm on rose key hole escutcheon	66460281007	66460281013	66460281016	66460281027	1
1 Q8 RBQY Guarnitura Q8 ros./bocc. yale Lever handle 8mm on rose - cyl. hole escutcheon	66460285007	66460285013	66460285016	66460285027	1
1 Q8 RBQWC Guarnitura Q8 ros./bocc. Wc Lever handle 8mm on rose wc hole escutcheon	66460288007	66460288013	66460288016	66460288027	1
2 Q8 RRC guarnitura rosetta rettangolare Q8 C/M molla dx/sx Lever handle 8mm on springloaded rectangular rose	66460210407	66460210413	66460210416	66460210427	1
2 Q8 RBR Guarnitura Q8 ros./bocc. rett. patent molla dx/sx Lever handle 8mm on springloaded rect rose key hole esc	66460211407	66460211413	66460211416	66460211427	1
2 Q8 RBYR Guarnitura Q8 ros./bocc. rett.yale molla dx/sx Lever handle 8mm on springloaded rect rose - cyl. hole esc	66460215407	66460215413	66460215416	66460215427	1
3 DK X 40 Martellina DK Q7 x 40 window handle DK x 40 mm	66460557007	66460557013	66460557016	66460557027	2
3 DK X 40 C/BUSS. Martellina DK Q7 x 40 con bussole D. 9,5 window handle DK x 40mm with pins D.9,5	66460558007	66460558013	66460558016	66460558027	2

⚡ Servizio G48: Articolo a magazzino e disponibile entro 48 dall'elaborazione dell'ordine. In base a disponibilita' e condizioni di vendita.  
G48 service: Item in stock and available within 48 hours of order processing. Based on availability and sales conditions.

## PORTA

## FINESTRA

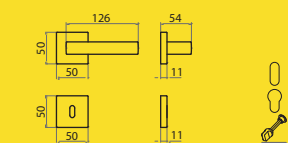

1 Ros 574

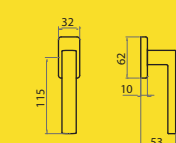

3

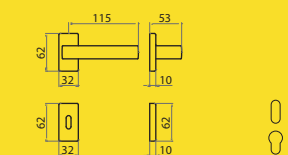

2 Ros 0006

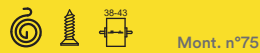

Per istruzioni di montaggio  
scansiona QR code,  
seleziona il numero di  
riferimento e segui le  
istruzioni.  
For assembly instructions  
scan the QR code, select the  
relevant assembly number  
and follow the instructions.



# Ottone Brass

118 Introduzione / Introduction  
120 Finiture / Finishes

122 ARIETE  
124 BAROCCO  
126 EASY  
128 EASY Q  
130 ELBA  
132 ELITE  
134 GINEVRA  
136 GOLF  
138 LADY  
140 LINEA  
142 MILENA  
144 NOVECENTO  
146 PIGNA  
148 R5200  
150 R716  
152 R716  
154 R771  
156 R775  
158 R901  
160 R988  
162 R988  
164 TIROL  
166 UNO



**L'ottone é una lega industriale di rame-zinco, nella quale il tenore di zinco é almeno del 50%. I primi utilizzi del rame e delle sue leghe risalgono a 5000 anni fa. Nel nostro caso la lega rappresenta una parte consistente della produzione e nei nostri stabilimenti viene trasformata dallo stato grezzo a semilavorati mediante processi di pressofusione, stampaggio a caldo, tranciatura e imbutitura, tornitura a seconda che si parta da lingotti, spezzoni di barra estrusa, lamiera, barra trafilata.**

**Brass is an industrial alloy of copper and zinc, of which zinc makes up at least 50%. The first use of copper and its alloys dates back to 5000 years ago. In our case the alloy represents a consistent part of our production and in our factories it is transformed from the original state to semi-finished products using processes of die casting, hot pressing, blanking and drawing, and turning according to whether the product is manufactured from ingots, cut down sizes of extruded bars, sheet or drawn bars.**

# Finiture Ottone Brass finishing

120

01

02

01

04

03

07

06

05

Brass

09

08

10

Handles



OLD	01	121
OANT	02	
OCL - BLACK	03	
OCS-PB	04	
OLS	05	
ONL-EB	06	
OLV	07	
OGV	08	
OBR	09	
OCL-OCS	10	
ONL	11	
OFA	12	
OFA-NO	13	
OCL	14	
GPLUS	15	
ONS	16	
OCL-PB	17	
OCS	18	
OCL-F1	19	
OCL-WHITE	20	



11

13

12

14

17

16

15

19

18

01

20

Ottone

Maniglie

# ARIETE

55696

Ariete

Brass



Handles



OCS



OCL



G-PLUS



	OLV	OCS	OCL	Conf. Pz.
1 PSQ8 RB Pomolo spostato Q8 ros.bocc.patent knob on rose with escutcheon key hole	55696702201	55696702203	55696702207	1
1 PS Q8 RBY Pomolo spostato Q8 ros.bocc.yale knob on rose with escutcheon cyl. hole	55696702601	55696702603	55696702607	1
2 PS Q8 RBOC Pomolo spostato Q8 ros.bocc.ovale copr.patent molla knob on springloaded oval rose with escutcheon key hole	55696702301	55696702303	55696702307	1
2 PS Q8 RBOYC Pomolo spostato Q8 ros.bocc.ovale copr.yale molla knob on springloaded oval rose with escutcheon cyl. hole	55696702701	55696702703	55696702707	1

## PORTA

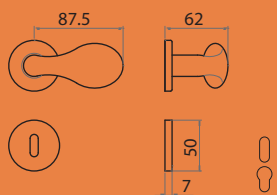

1 Ros 0005

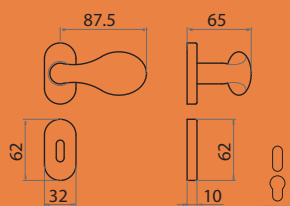

2 Ros 0006

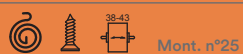

Per istruzioni di montaggio  
scansiona QR code,  
seleziona il numero di  
riferimento e segui le  
istruzioni.  
For assembly instructions  
scan the QR code, select the  
relevant assembly number  
and follow the instructions.



# BAROCCO

44290

Barocco

Brass



Handles



OBR

		OBR	Conf. Pz.
1	Q8 P90 Guarnitura Q8 placca patent 90 Lever handle 8mm on key plate 90	44290089000	6
1	Q8 P70 Guarnitura Q8 placca patent 70 Lever handle 8mm on key plate 70	44290087000	6
1	Q8 PY85 Guarnitura Q8 placca yale 85 Lever handle 8mm on cyl. plate 85	44290088500	6
2	GZ Cremonese gioco GZ Mechanism for window handle spindle 7 mm	44290401000	10
2	GZP Cremonese gioco GZ + PERNI Mechanism for window handle spindle 7 mm	44290402000	10
2	GZQ7 Cremonese gioco GZ + Q7 Mechanism for window handle spindle 7 mm	44290403000	10
2	MART Martellina Q7 window handle	44290500000	10

44290

Barocco

## PORTA

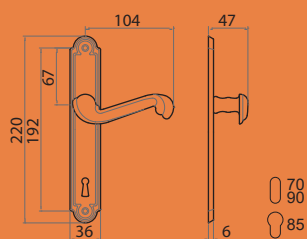

1 Placca BAROCCO



Mont. n°42

## FINESTRA

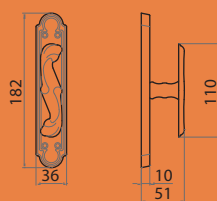

2

Mont. n°147

Ottone



Per istruzioni di montaggio  
scansiona QR code,  
seleziona il numero di  
riferimento e segui le  
istruzioni.  
For assembly instructions  
scan the QR code, select the  
relevant assembly number  
and follow the instructions.

Maniglie

# EASY

DESIGN FABRIZIO BIANCHETTI



OCL



OLV



OCS



OCS



OLV

	OLV	OCS	OCL	Conf. Pz.
1 Q8 R Guarnitura Q8 ros. senza bocc. Lever handle 8mm on rose	55014280001	55014280003	55014280007	1
1 Q8 RB Guarnitura Q8 ros./bocc. patent Lever handle 8mm on rose key hole escutcheon	55014281001	55014281003	55014281007	1
1 Q8 RBY Guarnitura Q8 ros./bocc. yale Lever handle 8mm on rose - cyl. hole escutcheon	55014285001	55014285003	55014285007	1
1 Q8 RBWC Guarnitura Q8 ros./bocc. Wc Lever handle 8mm on rose wc hole escutcheon	55014288001	55014288003	55014288007	1
2 Q8 ROC Guarnitura Q8 ros.ovale senza bocc molla Lever handle 8mm on springloaded oval rose	55014220501	55014220503	55014220507	1
2 Q8 RBOC Guarnitura Q8 ros/boc. ovale patent molla Lever handle 8mm on springloaded oval rose key hole escutcheon	55014221501	55014221503	55014221507	1
2 Q8 RBOYC Guarnitura Q8 ros/boc. ovale yale molla Lever handle 8mm on oval rose - cyl. hole escutcheon	55014225501	55014225503	55014225507	1
3 EZ IM Cremonese gioco EZ imp. maniglia Mechanism for window handle spindle 7 mm	55014456001	55014456003	55014456007	2
3 EZQ7 IM Cremonese gioco EZ + Q7 imp. maniglia Mechanism for window handle spindle 7 mm	55014457001	55014457003	55014457007	2
3 MART IM Martellina Q7 imp. Maniglia lever window handle	55014550001	55014550003	55014550007	2
4 DK X 40 Martellina DK Q7 x 40 window handle DK x 40 mm	55014557001	55014557003	55014557007	2
4 DK X 40 C/BUSS Martellina DK Q7 x 40 con bussole D. 9,5 window handle DK x 40mm with pins D.9,5	55014558001	55014558003	55014558007	2

55014

Easy

## PORTA

## FINESTRA

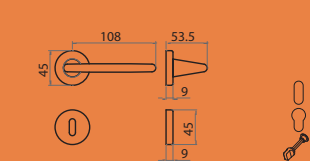

1 Ros 45x9



Mont. n°88-89

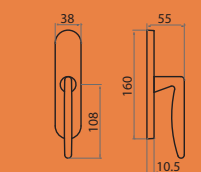

3

Mont. n°140-141

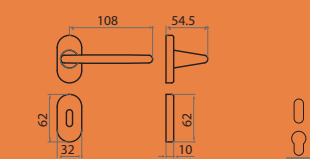

2 Ros 0006



Mont. n°25

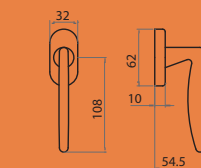

4



Mont. n°8



Per istruzioni di montaggio  
scansiona QR code,  
seleziona il numero di  
riferimento e segui le  
istruzioni.  
For assembly instructions  
scan the QR code, select the  
relevant assembly number  
and follow the instructions.

Ottone

Maniglie

# EASY Q

DESIGN FABRIZIO BIANCHETTI

55062

Easy Q

Brass



OCS



OCL



OLV



OCS

Handles

	OLV	OCS	OCL	Conf. Pz.
1 Q8 RQ Guarnitura Q8 ros. senza bocc. Lever handle 8mm on rose	55062280001	55062280003	55062280007	1
1 Q8 RBQ Guarnitura Q8 ros./bocc. patent Lever handle 8mm on rose key hole escutcheon	55062281001	55062281003	55062281007	1
1 Q8 RBQY Guarnitura Q8 ros./bocc. yale Lever handle 8mm on rose - cyl. hole escutcheon	55062285001	55062285003	55062285007	1
1 Q8 RBQWC Guarnitura Q8 ros./bocc. Wc Lever handle 8mm on rose wc hole escutcheon	55062288001	55062288003	55062288007	1
2 DK X 40-35 Martellina DK Q7 x 40 window handle DK x 40 mm	55062557001	55062557003	55062557007	2
2 DK X 40-35 C/BUSS. Martellina DK Q7 x 40 con bussole D. 9,5 window handle DK x 40mm with pins D.9,5	55062558001	55062558003	55062558007	2

55062

Easy Q

## PORTA

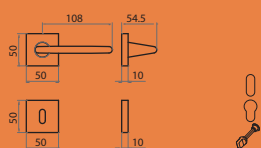

1 Ros 574



Mont. n°57-58

## FINESTRA

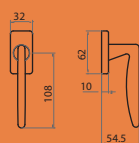

2



Mont. n°9

Ottone



Per istruzioni di montaggio  
scansiona QR code,  
seleziona il numero di  
riferimento e segui le  
istruzioni.  
For assembly instructions  
scan the QR code, select the  
relevant assembly number  
and follow the instructions.

Maniglie

# ELBA

55450

Elba

Brass



OCS



OCL

Handles

	OLV	OCS	OCL	Conf. Pz.
1 Q8 P90 Guarnitura Q8 placca patent 90 Lever handle 8mm on key plate 90	55450089001	55450089003	55450089007	1
1 Q8 P70 Guarnitura Q8 placca patent 70 Lever handle 8mm on key plate 70	55450087001	55450087003	55450087007	1
1 Q8 PY85 Guarnitura Q8 placca yale 85 Lever handle 8mm on cyl. plate 85	55450088501	55450088503	55450088507	1
2 Q8 P90RS Guarnitura Q8 placca stretta pat 90 Lever handle 8mm on reduced key plate 90	55450051001	55450051003	55450051007	1
2 Q8 P70RS Guarnitura Q8 placca stretta pat 70 Lever handle 8mm on reduced key plate 70	55450057001	55450057003	55450057007	1
2 Q8 PY85RS Guarnitura Q8 placca stretta yale 85 Lever handle 8mm on reduced cyl. plate 85	55450055001	55450055003	55450055007	1
3 Q8 R Guarnitura Q8 ros. senza bocc. Lever handle 8mm on rose	55450280001	55450280003	55450280007	1
3 Q8 RB Guarnitura Q8 ros./bocc. patent Lever handle 8mm on rose key hole escutcheon	55450281001	55450281003	55450281007	1
3 Q8 RBY Guarnitura Q8 ros./bocc. yale Lever handle 8mm on rose - cyl. hole escutcheon	55450285001	55450285003	55450285007	1
3 Q8 RBWC Guarnitura Q8 ros./bocc. Wc Lever handle 8mm on rose wc hole escutcheon	55450288001	55450288003	55450288007	1
4 Q8 ROC Guarnitura Q8 ros.ovale senza bocc. Lever handle 8mm on oval rose	55450220501	55450220503	55450220507	1
4 Q8 RBOC Guarnitura Q8 ros/boc. ovale patent Lever handle 8mm on oval rose key hole escutcheon	55450221501	55450221503	55450221507	1
4 Q8 RBOYC Guarnitura Q8 ros/boc. ovale Yale Lever handle 8mm on oval rose - cyl. hole escutcheon	55450225501	55450225503	55450225507	1

## PORTA

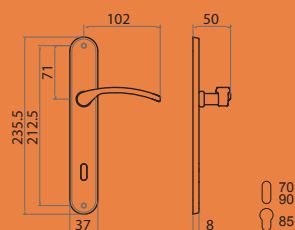

1 Placca ELBA

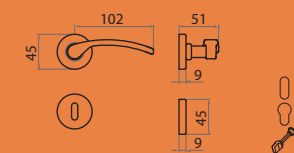

3 Ros 45X9

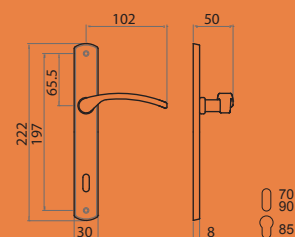

2 Placca STRETTA

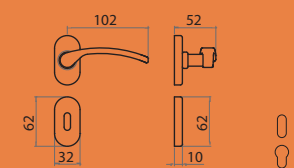

4 Ros 0006



Per istruzioni di montaggio scansiona QR code, seleziona il numero di riferimento e segui le istruzioni.  
For assembly instructions scan the QR code, select the relevant assembly number and follow the instructions.



# ELITE

55194

Elite

Brass



OBR



OLV



OLD



OLV



OLV



OLV

Handles

	OBR	OLV	OLD	Conf. Pz.
1 Q8 R Guarnitura Q8 ros. senza bocc. Lever handle 8mm on rose	55194280000	55194280001	55194280028	1
1 Q8 RB Guarnitura Q8 ros./bocc. patent Lever handle 8mm on rose key hole escutcheon	55194281000	55194281001	55194281028	1
1 Q8 RBY Guarnitura Q8 ros./bocc. yale Lever handle 8mm on rose - cyl. hole escutcheon	55194285000	55194285001	55194285028	1
1 Q8 RBWC Guarnitura Q8 ros./bocc. Wc Lever handle 8mm on rose wc hole escutcheon	55194288000	55194288001	55194288028	1
2 Q8 ROC Guarnitura Q8 ros.ovale senza bocc. Lever handle 8mm on oval rose	55194220500	55194220501	55194220528	1
2 Q8 RBOC Guarnitura Q8 ros/boc. ovale patent Lever handle 8mm on oval rose key hole escutcheon	55194221500	55194221501	55194221528	1
2 Q8 RBOYC Guarnitura Q8 ros/boc. ovale Yale Lever handle 8mm on oval rose - cyl. hole escutcheon	55194225500	55194225501	55194225528	1
3 Q8 RVV Guarnitura Q8 ros. senza bocc. Lever handle 8mm on rose	55194250000	55194250001	55194250028	1
3 Q8 RBVV Guarnitura Q8 ros./bocc. patent Lever handle 8mm on rose key hole escutcheon	55194251000	55194251001	55194251028	1
4 MART Martellina Q7 window handle	55194500000	55194500001	55194500028	2
5 DK X 40 Martellina DK Q7 x 40 window handle DK x 40 mm	55194557000	55194557001	55194557028	2
5 DK X 40 C/BUSS. Martellina DK Q7 x 40 con bussole D. 9,5 window handle DK x 40mm with pins D.9,5	55194558000	55194558001	55194558028	2

55194

Elite

## PORTA

## FINESTRA

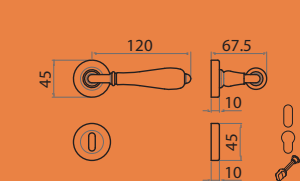

1 Ros 45X9

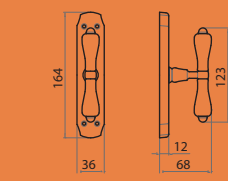

4

Mont. n°147

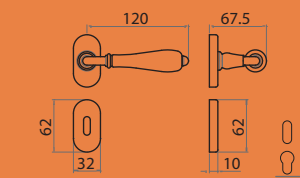

2 Ros 0006

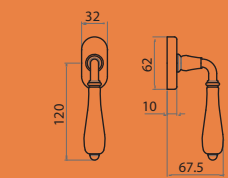

5

Mont. n°4

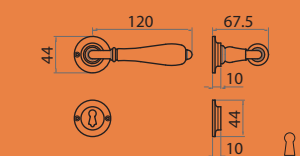

3 Ros 45x10 V.V.

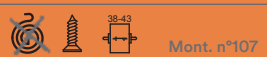

Per istruzioni di montaggio  
scansiona QR code,  
seleziona il numero di  
riferimento e segui le  
istruzioni.  
For assembly instructions  
scan the QR code, select the  
relevant assembly number  
and follow the instructions.

Ottone

Maniglie

# GINEVRA

DESIGN FABRIZIO BIANCHETTI

55846

Giavera

Brass



OCL-OCS



OLS



OCL-OCS



OCL-OCS

Handles

	OLS	OCL/OCS	Conf. Pz.
1 Q8R Guarnitura Q8 ros. senza bocc. Lever handle 8mm on rose	55846230302	5584623030703	1
1 Q8 RB Guarnitura Q8 ros./bocc. patent Lever handle 8mm on rose key hole escutcheon	55846231302	5584623130703	1
1 Q8 RBY Guarnitura Q8 ros./bocc. yale Lever handle 8mm on rose - cyl. hole escutcheon	55846235302	5584623530703	1
1 Q8 RBWC Guarnitura Q8 ros./bocc. Wc Lever handle 8mm on rose wc hole escutcheon	55846238302	5584623830703	1
2 Q8 ROC Guarnitura Q8 ros.ovale senza bocc molla Lever handle 8mm on springloaded oval rose	55846220502	5584622050703	1
2 Q8 RBOC Guarnitura Q8 ros/boc. ovale patent molla Lever handle 8mm on springloaded oval rose key hole escutcheon	55846221502	5584622150703	1
2 Q8 RBOYC Guarnitura Q8 ros/boc. ovale yale molla Lever handle 8mm on oval rose - cyl. hole escutcheon	55846225502	5584622550703	1
3 EZ IM Cremonese gioco EZ imp. maniglia Mechanism for window handle spindle 7 mm	55846456002	5584645600703	2
3 EZQ7 IM Cremonese gioco EZ + Q7 imp. maniglia Mechanism for window handle spindle 7 mm	55846457002	5584645700703	2
3 MART IM Martellina Q7 imp. Maniglia lever window handle	55846550002	5584655000703	2
4 DK x 40-35 Martellina DK Q7 x 40 window handle DK x 40 mm	55846557002	5584655700703	2
4 DK x 40-35 C/BUSS. Martellina DK Q7 x 40 con bussole D. 9,5 window handle DK x 40mm with pins D.9,5	55846558002	5584655800703	2

55846

Ginevra

## PORTA

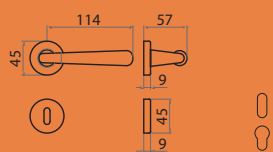

1 Ros 45x9



Mont. n°88-89

## FINESTRA

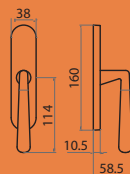

3

Mont. n°140-141

## PORTA

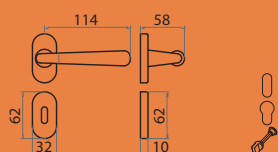

2 Ros 0006



Mont. n°25

## FINESTRA

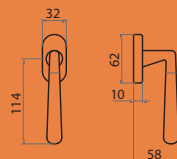

4



Mont. n°8



Per istruzioni di montaggio  
scansiona QR code,  
seleziona il numero di  
riferimento e segui le  
istruzioni.  
For assembly instructions  
scan the QR code, select the  
relevant assembly number  
and follow the instructions.

Ottone

Maniglie

# GOLF

55146

Golf

Brass



OCS



OCL



G-PLUS



OLV



OLV

Handles

	OLV	OCS	OCL	Conf. Pz.
1 Q8 R Guarnitura Q8 ros. senza bocc. Lever handle 8mm on rose	55146280001	55146280003	55146280050	1
1 Q8 RB Guarnitura Q8 ros./bocc. patent Lever handle 8mm on rose key hole escutcheon	55146281001	55146281003	55146281007	1
1 Q8 RBY Guarnitura Q8 ros./bocc. yale Lever handle 8mm on rose - cyl. hole escutcheon	55146285001	55146285003	55146285007	1
1 Q8 RBWC Guarnitura Q8 ros./bocc. Wc Lever handle 8mm on rose wc hole escutcheon	55146288001	55146288003	55146288007	1
2 Q8 ROC Guarnitura Q8 ros.ovale senza bocc molla Lever handle 8mm on springloaded oval rose	55146220501	55146220503	55146220507	1
2 Q8 RBOC Guarnitura Q8 ros/boc. ovale patent molla Lever handle 8mm on springloaded oval rose key hole escutcheon	55146221501	55146221503	55146221507	1
2 Q8 RBOYC Guarnitura Q8 ros/boc. ovale yale molla Lever handle 8mm on oval rose - cyl. hole escutcheon	55146225501	55146225503	55146225507	1
3 EZ IM Cremonese gioco EZ imp. maniglia Mechanism for window handle spindle 7 mm	55146456001	55146456003	55146456007	2
3 EZQ7 IM Cremonese gioco EZ + Q7 imp. maniglia Mechanism for window handle spindle 7 mm	55146457001	55146457003	55146457007	2
3 MART IM Martellina Q7 imp. Maniglia lever window handle	55146550001	55146550003	55146550007	2
4 DK X 40 Martellina DK Q7 x 40 window handle DK x 40 mm	55146557001	55146557003	55146557007	2

55146

Golf

## PORTA

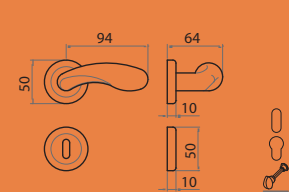

Ros GOLF



## FINESTRA

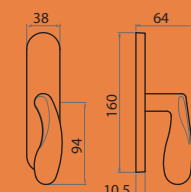

3

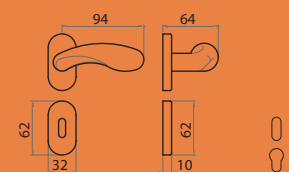

Ros 0006

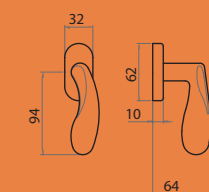

4



Per istruzioni di montaggio  
scansiona QR code,  
seleziona il numero di  
riferimento e segui le  
istruzioni.  
For assembly instructions  
scan the QR code, select the  
relevant assembly number  
and follow the instructions.

Ottone

Maniglie

# LADY

44394

Lady

Brass



OF



OF

Handles

	OF	Conf. Pz.
1 Q8 P90 Guarnitura Q8 placca patent 90 Lever handle 8mm on key plate 90	44394089006	4
1 Q8 P70 Guarnitura Q8 placca patent 70 Lever handle 8mm on key plate 70	44394087006	4
1 Q8 PY85 Guarnitura Q8 placca yale 85 Lever handle 8mm on cyl. plate 85	44394088506	4
2 GZ Cremonese gioco GZ Mechanism for window handle spindle 7 mm	44394401006	6
2 GZP Cremonese gioco GZ + PERNI Mechanism for window handle spindle 7 mm	44394402006	6
2 GZQ7 Cremonese gioco GZ + Q7 Mechanism for window handle spindle 7 mm	44394403006	6
2 MART Martellina Q7 window handle	44394500006	6
3 DK x 40 Martellina DK Q7 x 40 window handle DK x 40 mm	44394555006	2

44394

Lady

## PORTA

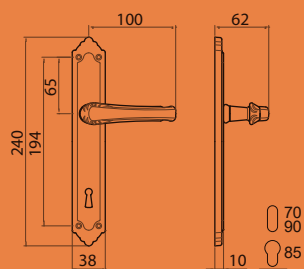

1 Placca LADY



Mont. n°41

## FINESTRA

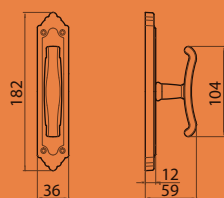

2

Mont. n°147

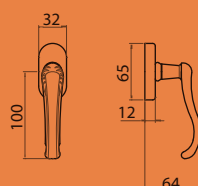

3



Mont. n°4



Per istruzioni di montaggio scansiona QR code, seleziona il numero di riferimento e segui le istruzioni.  
For assembly instructions scan the QR code, select the relevant assembly number and follow the instructions.

Ottone

Maniglie



# LINEA

DESIGN DILETTA CAUSIN

66540

Linea

Zamak



ZCL



ZNO



TITANIUM

Handles

	ZCL	ZNO	TITANIUM	Conf. Pz.
1 Q8 R Guarnitura Q8 ros. senza bocc. Lever handle 8mm on rose	66540210407	66540210416	66540210454	1
1 Q8 RB Guarnitura Q8 ros./bocc. patent Lever handle 8mm on rose key hole escutcheon	66540211407	66540211416	66540211454	1
1 Q8 RBY Guarnitura Q8 ros./bocc. yale Lever handle 8mm on rose - cyl. hole escutcheon	66540215407	66540215416	66540215454	1

66540

Linea

## PORTA

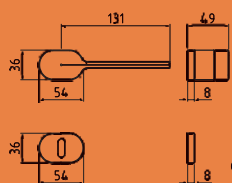

1 Ros 575



Mont. n°105

Zama



Per istruzioni di montaggio  
scansiona QR code,  
seleziona il numero di  
riferimento e segui le  
istruzioni.  
For assembly instructions  
scan the QR code, select the  
relevant assembly number  
and follow the instructions.

Maniglie

# MILENA

55744

Milena

Brass



OCL



OCS



OLV



OLV



OLV

Handles

	OLV	OCS	OGV	OCL	OS	Cont. Pz.
1 Q8 P90 Guarnitura Q8 placca patent 90 Lever handle 8mm on key plate 90	55744089001	55744089003	55744089004	55744089007	55744089008	1
1 Q8 P70 Guarnitura Q8 placca patent 70 Lever handle 8mm on key plate 70	55744087001	55744087003	55744087004	55744087007	55744087008	1
1 Q8 PY85 Guarnitura Q8 placca yale 85 Lever handle 8mm on cyl. plate 85	55744088501	55744088503	55744088504	55744088507	55744088508	1
2 Q8 P90RS Guarnitura Q8 placca stretta pat 90 Lever handle 8mm on reduced key plate 90	55744051001	55744051003	55744051004	55744051007	55744051008	1
2 Q8 P70RS Guarnitura Q8 placca stretta pat 70 Lever handle 8mm on reduced key plate 70	55744057001	55744057003	55744057004	55744057007	55744057008	1
2 Q8 PY85RS Guarnitura Q8 placca stretta yale 85 Lever handle 8mm on reduced cyl. plate 85	55744055001	55744055003	55744055004	55744055007	55744055008	1
3 Q8 R Guarnitura Q8 ros. senza bocc. Lever handle 8mm on rose	55744280501	55744280503	55744280504	55744280507	55744280508	1
3 Q8 RB Guarnitura Q8 ros./bocc. patent Lever handle 8mm on rose key hole escutcheon	55744281501	55744281503	55744281504	55744281507	55744281508	1
3 Q8 RBY Guarnitura Q8 ros./bocc. yale Lever handle 8mm on rose - cyl. hole escutcheon	55744285501	55744285503	55744285504	55744285507	55744285508	1
3 Q8 RBWC Guarnitura Q8 ros./bocc. Wc Lever handle 8mm on rose wc hole escutcheon	55744288001	55744288003	55744288004	55744288007	55744288008	1
4 Q8 ROC Guarnitura Q8 ros.ovale senza bocc. Lever handle 8mm on oval rose	55744220501	55744220503	55744220504	55744220507	55744220508	1
4 Q8 RBOC Guarnitura Q8 ros/boc. ovale patent Lever handle 8mm on oval rose key hole escutcheon	55744221501	55744221503	55744221504	55744221507	55744221508	1
4 Q8 RBOYC Guarnitura Q8 ros/boc. ovale Yale Lever handle 8mm on oval rose - cyl. hole escutcheon	55744225501	55744225503	55744225504	55744225507	55744225508	1
5 EZ Cremonese gioco EZ Mechanism for window handle spindle 7 mm	55744406001	55744406003	55744406004	55744406007	55744406008	2
5 EZQ7 Cremonese gioco EZ + Q7 Mechanism for window handle spindle 7 mm	55744407001	55744407003	55744407004	55744407007	55744407008	2
5 MART Martellina Q7 window handle	55744500001	55744500003	55744500004	55744500007	55744500008	2
6 DK x 40-35 Martellina DK Q7 x 40-35 window handle DK x 40-35mm	55744577001	55744577003	55744577004	55744577007	55744577008	2
6 DK x 40-35 C/BUSS Martellina DK Q7 x 40-35 con bussole window handle DK x 40-35 mm with pins D.9,5	55744578001	55744578003	55744578004	55744578007	55744578008	2

## PORTA

## FINESTRA

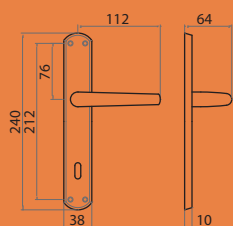

1 Placca MILENA Mont. n°38

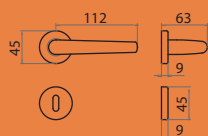

3 Ros 45X9 Mont. n°88-89

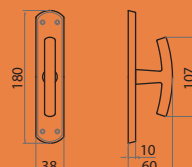

5 Mont. n°145-146

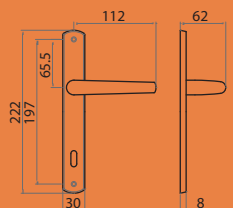

2 Placca STRETTA Mont. n°37

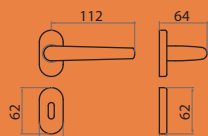

4 Ros 0006 Mont. n°25

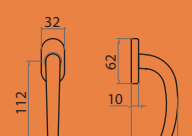

6 DK-2P Mont. n°8



Per istruzioni di montaggio scansiona QR code, seleziona il numero di riferimento e segui le istruzioni.  
For assembly instructions scan the QR code, select the relevant assembly number and follow the instructions.

# NOVECENTO

55196

Novecento

Brass



OLV



OBR



OCL



OLD



OFA



OLV



OLV



OLV

Handles

	OBR	OLV	OCL	OLD	OFA	Conf. Pz.
1 Q8 R Guarnitura Q8 ros. senza bocc. Lever handle 8mm on rose	55196280000	55196280001	55196280007	55196280028	55196280029	1
1 Q8 RB Guarnitura Q8 ros./bocc. patent Lever handle 8mm on rose key hole escutcheon	55196281000	55196281001	55196281007	55196281028	55196281029	1
1 Q8 RBY Guarnitura Q8 ros./bocc. yale Lever handle 8mm on rose - cyl. hole escutcheon	55196285000	55196285001	55196285007	55196285028	55196285029	1
1 Q8 RBWC Guarnitura Q8 ros./bocc. Wc Lever handle 8mm on rose wc hole escutcheon	55196288000	55196288001	55196288007	55196288028	55196288029	1
2 Q8 RVV Guarnitura Q8 ros. senza bocc. Lever handle 8mm on rose	55196250000	55196250001	55196250007	55196250028	55196250029	1
2 Q8 RBVV Guarnitura Q8 ros./bocc. patent Lever handle 8mm on rose key hole escutcheon	55196251000	55196251001	55196251007	55196251028	55196251029	1
3 Q8 ROC Guarnitura Q8 ros.ovale senza bocc. Lever handle 8mm on oval rose	55196220500	55196220501	55196220507	55196220528	55196220529	1
3 Q8 RBOC Guarnitura Q8 ros/boc. ovale patent Lever handle 8mm on oval rose key hole escutcheon	55196221500	55196221501	55196221507	55196221528	55196221529	1
3 Q8 RBOYC Guarnitura Q8 ros/boc. ovale Yale Lever handle 8mm on oval rose - cyl. hole escutcheon	55196225500	55196225501	55196225507	55196225528	55196225529	1
4 MART Martellina Q7 window handle	55196500000	55196500001	55196500007	55196500028	55196500029	2
5 DK x 40-35 Martellina DK Q7 x 40-35 window handle DK x 40-35mm	55196577000	55196577001	55196577007	55196577028	55196577029	2
5 DK x 40-35 C/BUSS Martellina DK Q7 x 40-35 con bussole window handle DK x 40-35 mm with pins D.9,5	55196578000	55196578001	55196578007	55196578028	55196578029	2

⚡ Servizio G48: Articolo a magazzino e disponibile entro 48 dall'elaborazione dell'ordine. In base a disponibilita' e condizioni di vendita.  
G48 service: Item in stock and available within 48 hours of order processing. Based on availability and sales conditions.

## PORTA

## FINESTRA

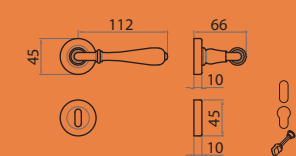

1 Ros 45X9  
Mont. n°88-89

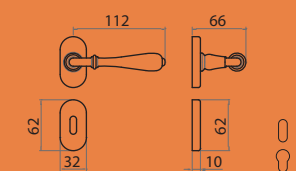

2 Ros 0006  
Mont. n°25

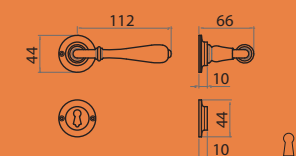

3 Ros 45x10 V.V.  
Mont. n°107

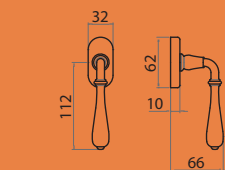

4  
Mont. n°8

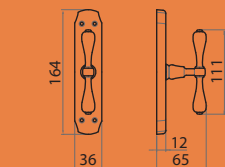

5  
Mont. n°147



Per istruzioni di montaggio  
scansiona QR code,  
seleziona il numero di  
riferimento e segui le  
istruzioni.  
For assembly instructions  
scan the QR code, select the  
relevant assembly number  
and follow the instructions.

# PIGNA

55442

Pigna

Brass



OLV



OCL



G-PLUS



OLV



OLV

Handles

	OLV	OCS	OCL	Conf. Pz.
1 Q8 R50 Guarnitura Q8 ros.50x7 senza bocc. Lever handle 8mm on rose 50x7mm	55442250501	55442250503	55442250507	1
1 Q8 RB50 Guarnitura Q8 ros./bocc. 50x7 patent Lever handle 8mm on rose 50X7 key hole escutcheon	55442251501	55442251503	55442251507	1
1 Q8 RBY50 Guarnitura Q8 ros./bocc. yale Lever handle 8mm on rose - cyl. hole escutcheon	55442255501	55442255503	55442255507	1
1 Q8 RBWC Guarnitura Q8 ros./bocc. Wc Lever handle 8mm on rose wc hole escutcheon	55442258501	55442258503	55442258507	1
2 Q8 ROC Guarnitura Q8 ros.ovale senza bocc molla Lever handle 8mm on springloaded oval rose	55442220501	55442220503	55442220507	1
2 Q8 RBOC Guarnitura Q8 ros/boc. ovale patent molla Lever handle 8mm on springloaded oval rose key hole escutcheon	55442221501	55442221503	55442221507	1
2 Q8 RBOYC Guarnitura Q8 ros/boc. ovale yale molla Lever handle 8mm on oval rose - cyl. hole escutcheon	55442225501	55442225503	55442225507	1
3 EZ IM Cremonese gioco EZ imp. maniglia Mechanism for window handle spindle 7 mm	55442456001	55442456003	55442456007	2
3 EZQ7 IM Cremonese gioco EZ + Q7 imp. maniglia Mechanism for window handle spindle 7 mm	55442457001	55442457003	55442457007	2
3 MART IM Martellina Q7 imp. Maniglia lever window handle	55442550001	55442550003	55442550007	2
4 DK X 40 Martellina DK Q7 x 40 window handle DK x 40 mm	55442557001	55442557003	55442557007	2
4 DK X 40 C/BUSS. Martellina DK Q7 x 40 con bussole D. 9,5 window handle DK x 40mm with pins D.9,5	55442558001	55442558003	55442558007	2

55442

Pigna

## PORTA

## FINESTRA

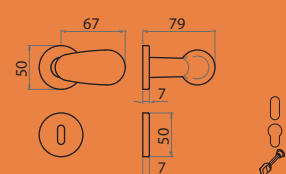

1 Ros 0005

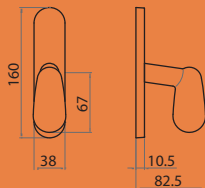

3

Mont. n°140-141

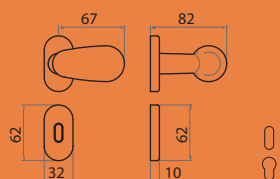

2 Ros 0006

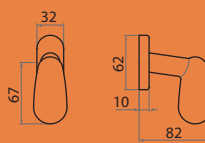

4



Per istruzioni di montaggio  
scansiona QR code,  
seleziona il numero di  
riferimento e segui le  
istruzioni.  
For assembly instructions  
scan the QR code, select the  
relevant assembly number  
and follow the instructions.

Ottone

Maniglie



# R5200

R5200

R5200

Brass



OCS



OCL



ONL/NO



OFA/NO



OCL/PB



OCL/PB

Handles

	OCS-PB	OCL-PB	OFA-NO	ONL-NO	Conf. Pz.
1 Q8 R Guarnitura Q8 ros. senza bocc. Lever handle 8mm on rose	R5200000505C360	R5200000505C760	R5200000505UF60	R5200000505UN60	1
1 Q8 RB BB Guarnitura Q8 ros./bocc. BB Lever handle 8mm on rose - key escutcheon	R5200000512C360	R5200000512C760	R5200000512UF60	R5200000512UN60	1
1 Q8 RBY Guarnitura Q8 ros./bocc. yale Lever handle 8mm on rose - cyl. hole escutcheon	R5200000550C360	R5200000550C760	R5200000550UF60	R5200000550UN60	1
1 Q8 RBWC Guarnitura Q8 ros./bocc. Wc Lever handle 8mm on rose - wc 6mm function	R5200000588C360	R5200000588C760	R5200000588UF60	R5200000588UN60	1
2 DK x 35 VM C/BUSS. Martellina DK Q7x35 c/bus D.9,5 mm viti metriche window handle DK x 35 mm with pins D.9,5 metric screws	R5200000480C390	R5200000480C790	R5200000480UF90	R5200000480UN90	1
3 DK x 42 C/CHIAVE VM C/BUSS. Martellina con chiave DK Q7x42 c/bus D.9,5 mm viti metriche window handle DK x 42mm with key / pins D.9,5 with screws	R520000A484C390	R520000A484C790	R520000A484UF90	R520000A484UN90	1

R5200

## PORTA

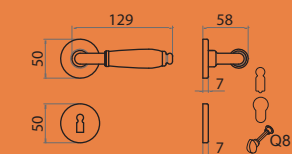

1 Ros 0005



## FINESTRA

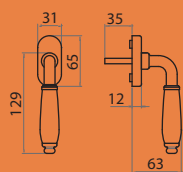

2 Gioco in ferro

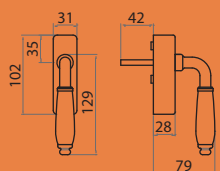

3 RG



R5200

Ottone



Per istruzioni di montaggio  
scansiona QR code,  
seleziona il numero di  
riferimento e segui le  
istruzioni.  
For assembly instructions  
scan the QR code, select the  
relevant assembly number  
and follow the instructions.

Maniglie

# R716

R716

R716

Brass



OFA



OLD



OANT



OANT



OANT

Handles

	OLD	OFA	OANT	Conf. Pz.
1 Q8 R Guarnitura Q8 ros. senza bocc. Lever handle 8mm on rose	R07160005052860	R07160005052960	R07160005054260	1
1 Q8 RB Guarnitura Q8 ros./bocc. BB Lever handle 8mm on rose - key escutcheon	R07160005122860	R07160005122960	R07160005124260	1
1 Q8 RBY Guarnitura Q8 ros./bocc. yale Lever handle 8mm on rose - cyl. hole escutcheon	R07160005502860	R07160005502960	R07160005504260	1
1 Q8 RBWC Guarnitura Q8 ros./bocc. Wc Lever handle 8mm on rose - wc 6mm function	R07160005802860	R07160005802960	R07160005804260	1
2 DK x 35 C/BUSS. Martellina DK Q7x35 c/bus D.9,5 mm viti metriche window handle DK x 35 mm with pins D.9,5 metric screws	R07160004802890	R07160004802990	R07160004804290	1
3 DK x 42 C/CHIAVE C/BUSS. Martellina con chiave DK Q7x42 c/bus D.9,5 mm viti metriche window handle DK x 42mm with key / pins D.9,5 with screws	R071600A4842890	R071600A4842990	R071600A4844290	1

R716

## PORTA

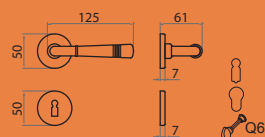

1 Ros 0005



Mont. n°93-94

## FINESTRA

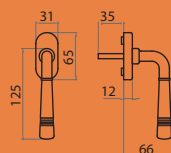

2 Gioco in ferro



Mont. n°4

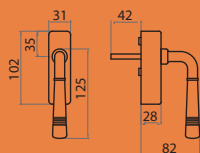

3 RG



Mont. n°11

R716

Ottone



Per istruzioni di montaggio  
scansiona QR code,  
seleziona il numero di  
riferimento e segui le  
istruzioni.  
For assembly instructions  
scan the QR code, select the  
relevant assembly number  
and follow the instructions.

Maniglie

# R716

R07160

R716

Brass



OCL-M4



OLV-M1



ONS-M9



OCL-M4



OCL-M4

Handles

	OLV	OCL	ONS	Conf. Pz.
1 Q8 R Guarnitura Q8 ros. senza bocc. Lever handle 8mm on rose	R07160005050160	R07160005050760	R07160005052760	1
1 Q8 RB Guarnitura Q8 ros./bocc. BB Lever handle 8mm on rose - key escutcheon	R07160005120160	R07160005120760	R07160005122760	1
1 Q8 RBY Guarnitura Q8 ros./bocc. yale Lever handle 8mm on rose - cyl. hole escutcheon	R07160005500160	R07160005500760	R07160005502760	1
1 Q8 RBWC Guarnitura Q8 ros./bocc. Wc Lever handle 8mm on rose - wc 6mm function	R07160005800160	R07160005800760	R07160005802760	1
2 DK x 35 C/BUSS. Martellina DK Q7x35 c/bus D.9,5 mm viti metriche window handle DK x 35 mm with pins D.9,5 metric screws	R07160004800190	R07160004800790	R07160004802790	1
3 DK x 42 C/CHIAVE C/BUSS. Martellina con chiave DK Q7x42 c/bus D.9,5 mm viti metriche window handle DK x 42mm with key / pins D.9,5 with screws	R071600A4840190	R071600A4840790	R071600A4842790	1

R07160

## PORTA

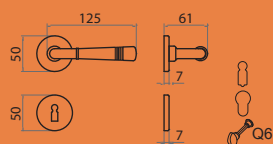

Ros 0005



Mont. n°93-94

## FINESTRA

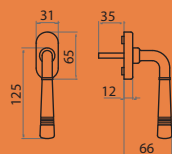

2

Gioco in ferro



Mont. n°4

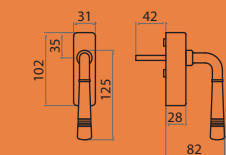

3 RG



Mont. n°11

R716

Ottone



Per istruzioni di montaggio  
scansiona QR code,  
seleziona il numero di  
riferimento e segui le  
istruzioni.  
For assembly instructions  
scan the QR code, select the  
relevant assembly number  
and follow the instructions.

Maniglie

# R771

R0771

R771

Brass



OLV



OCS



OCL



ONS

Handles



OLV



OLV

	OLV	OCS	OCL	ONS	Conf. Pz.
1 Q8 R Guarnitura Q8 ros. senza bocc. Lever handle 8mm on rose	R07710005050160	R07710005050360	R07710005050760	R07710005052760	1
1 Q8 RB Guarnitura Q8 ros./bocc. BB Lever handle 8mm on rose - key escutcheon	R07710005120160	R07710005120360	R07710005120760	R07710005122760	1
1 Q8 RBY Guarnitura Q8 ros./bocc. yale Lever handle 8mm on rose - cyl. hole escutcheon	R07710005500160	R07710005500360	R07710005500760	R07710005502760	1
1 Q8 RBWC Guarnitura Q8 ros./bocc. Wc Lever handle 8mm on rose - wc 6mm function	R07710005800160	R07710005800360	R07710005800760	R07710005802760	1
2 DK x 35 C/BUSS. Martellina DK Q7x35 c/bussole D.9,5 mm viti metriche window handle DK x 35 mm with pins D.9,5 metric screws	R07710004800190	R07710004800390	R07710004800790	R07710004802790	1
3 DK x 42 C/CHIAVE C/BUSS. Martellina con chiave DK Q7x42 c/bus D.9,5 mm viti metriche window handle DK x 42mm with key / pins D.9,5 with screws	R077100A4840190	R077100A4840390	R077100A4840790	R077100A4842790	1

## PORTA

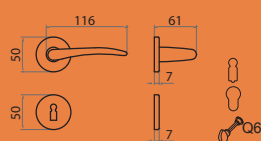

1 Ros 0005



Mont. n°93-94

## FINESTRA

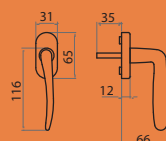

2

Gioco in ferro



Mont. n°4

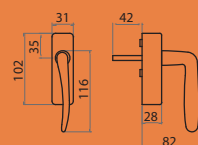

3 RG



Mont. n°11



Per istruzioni di montaggio  
scansiona QR code,  
seleziona il numero di  
riferimento e segui le  
istruzioni.  
For assembly instructions  
scan the QR code, select the  
relevant assembly number  
and follow the instructions.



# R775

R0775

R775

Zamak



ZCS



GCTOL



ZCL



ZNS



ZCS



ZCS

Handles

	ZCL	GCTOL	ZCS	ZNS	Conf. Pz.
1 Q8 R Guarnitura Q8 ros. senza bocc. Lever handle 8mm on rose	R07750005050760	R07750005051260	R07750005051360	R07750005052760	1
1 Q8 RB Guarnitura Q8 ros./bocc. BB Lever handle 8mm on rose - key escutcheon	R07750005120760	R07750005121260	R07750005121360	R07750005122760	1
1 Q8 RB Guarnitura Q8 ros./bocc. patent Lever handle 8mm on rose - key escutcheon	R07750005100760	R07750005101260	R07750005101360	R07750005102760	1
1 Q8 RBY Guarnitura Q8 ros./bocc. yale Lever handle 8mm on rose - cyl. hole escutcheon	R07750005500760	R07750005501260	R07750005501360	R07750005502760	1
1 Q8 RBWC Guarnitura Q8 ros./bocc. Wc Lever handle 8mm on rose - wc 6mm function	R07750005800760	R07750005801260	R07750005801360	R07750005802760	1
2 DK x 35 C/BUSS. Martellina DK Q7x35 c/bussole D.9,5 mm viti metriche window handle DK x 35 mm with pins D.9,5 metric screws	R07750004800790	R07750004801290	R07750004801390	R07750004802790	1
3 DK x 42 C/CHIAVE C/BUSS. Martellina con chiave DK Q7x42 c/bussole D.9,5 mm viti metriche window handle DK x 42mm with key / pins D.9,5 with screws	R077500A4840790	R077500A4841290	R077500A4841390	R077500A4842790	1

R 0775

R775

## PORTA

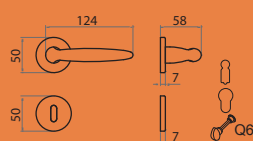

1 Ros 0005



Mont. n°93-94

## FINESTRA

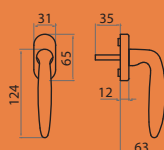

2

Gioco in ferro



Mont. n°4

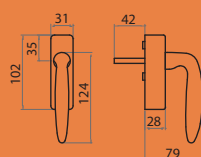

3 RG



Mont. n°11



Per istruzioni di montaggio  
scansiona QR code,  
seleziona il numero di  
riferimento e segui le  
istruzioni.  
For assembly instructions  
scan the QR code, select the  
relevant assembly number  
and follow the instructions.

Zama

Maniglie

# R901

R0901

R901

Brass



OLV



OCL



OLD



OFA



OANT



OLV



OLV

Handles

	OLV	OCL	OLD	OFA	OANT	Conf. Pz.
1 Q8 R Guarnitura Q8 ros. senza bocc. Lever handle 8mm on rose	R09010005050160	R09010005050760	R09010005052860	R09010005052960	R09010005054260	1
1 Q8 RB BB Guarnitura Q8 ros./bocc. BB Lever handle 8mm on rose - key escutcheon	R09010005120160	R09010005120760	R09010005122860	R09010005122960	R09010005124260	1
1 Q8 RBY Guarnitura Q8 ros./bocc. yale Lever handle 8mm on rose - cyl. hole escutcheon	R09010005500160	R09010005500760	R09010005502860	R09010005502960	R09010005504260	1
1 Q8 RBWC Guarnitura Q8 ros./bocc. Wc Lever handle 8mm on rose - wc 6mm function	R09010005800160	R09010005800760	R09010005802860	R09010005802960	R09010005804260	1
2 DK x 35 VM C/BUSS. Martellina DK Q7x35 c/bus D.9,5 mm viti metriche window handle DK x 35 mm with pins D.9,5 metric screws	R09010004800190	R09010004800790	R09010004802890	R09010004802990	R09010004804290	1
3 DK x 42 C/CHIAVE VM C/BUSS. Martellina con chiave DK Q7x42 c/bus D.9,5 mm viti metriche window handle DK x 42mm with key / pins D.9,5 with screws	R090100A4840190	R090100A4840790	R090100A4842890	R090100A4842990	R090100A4844290	1

R0901

R901

## PORTA

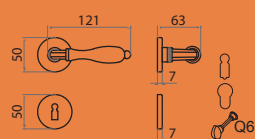

1 Ros 0005



Mont. n°93-94

## FINESTRA

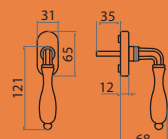

2

Gioco in ferro



Mont. n°4

3 RG



Mont. n°11

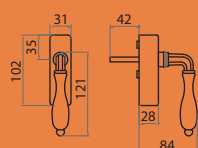

Per istruzioni di montaggio  
scansiona QR code,  
seleziona il numero di  
riferimento e segui le  
istruzioni.  
For assembly instructions  
scan the QR code, select the  
relevant assembly number  
and follow the instructions.

Ottone

Maniglie

# R988

R0988

R988

Brass



ONL



OCL



OCL



OCL



OCL

Handles

	OCS	OCL	ONS	Conf. Pz.
1 Q8 RQ Guarnitura Q8 ros. senza bocc. Lever handle 8mm on rose	R09880544050360	R09880544050760	R09880544052760	1
1 Q8 RBQ Guarnitura Q8 ros./bocc. patent Lever handle 8mm on rose - key escutcheon with wooden screw	R09880544100360	R09880544100760	R09880544102760	1
1 Q8 RBQY Guarnitura Q8 ros./bocc. yale Lever handle 8mm on rose - cyl. hole escutcheon	R09880544500360	R09880544500760	R09880544502760	1
1 Q8 RBQWC Guarnitura Q8 ros./bocc. Wc Lever handle 8mm on rose wc hole escutcheon	R09880544800360	R09880544800760	R09880544802760	1
2 DK X 35 C/BUSS. Martellina DK Q7x35 c/bussole D,9,5 mm viti metriche window handle DK x 35 mm with pins D,9,5 metric screws	R098800C4800390	R098800C4800790	R098800C4802790	1
3 DK X 42 C/CHIAVE C/BUSS. Martellina con chiave DK Q7x42 c/bussole D,9,5 mm viti metric window handle DK x 42mm with key / pins D,9,5 with screws	R098800A4840390	R098800A4840790	R098800A4842790	1

R0988

R988

## PORTA

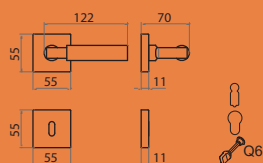

1 Ros 544



## FINESTRA

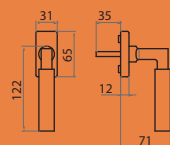

2 Gioco in ferro

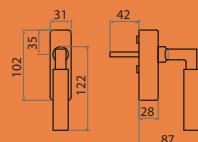

3 RG



Per istruzioni di montaggio  
scansiona QR code,  
seleziona il numero di  
riferimento e segui le  
istruzioni.  
For assembly instructions  
scan the QR code, select the  
relevant assembly number  
and follow the instructions.

Ottone

Maniglie

# R988

R0988

R988

Brass



OCL



OCS



ONS



OCL



OCL

Handles

	ONL	OCL-EB	ONL-EB	Conf. Pz.
1 Q8 RQ Guarnitura Q8 ros. senza bocc. Lever handle 8mm on rose	R09880544053060	R0988054405E760	R0988054405EN60	1
1 Q8 RBQ Guarnitura Q8 ros./bocc. patent Lever handle 8mm on rose - key escutcheon with wooden screw	R09880544103060	R0988054410E760	R0988054410EN60	1
1 Q8 RBQY Guarnitura Q8 ros./bocc. yale Lever handle 8mm on rose - cyl. hole escutcheon	R09880544503060	R0988054450E760	R0988054450EN60	1
1 Q8 RBQWC Guarnitura Q8 ros./bocc. Wc Lever handle 8mm on rose wc hole escutcheon	R09880544803060	R0988054480E760	R0988054480EN60	1
2 DK X 35 C/BUSS. Martellina DK Q7x35 c/bussole D.9,5 mm viti metriche window handle DK x 35 mm with pins D.9,5 metric screws	R098800C4803090	R098800C480E790	R098800C480EN90	1
3 DK X 42 C/CHIAVE C/BUSS. Martellina con chiave DK Q7x42 c/bussole D.9,5 mm viti metriche window handle DK x 42mm with key / pins D.9,5 with screws	R098800A4843090	R098800A484E790	R098800A484EN90	1

R0988

R988

## PORTA

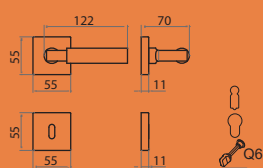

1 Ros 544



## FINESTRA

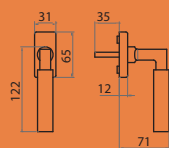

2 Gioco in ferro

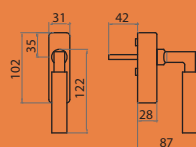

3 RG



Per istruzioni di montaggio  
scansiona QR code,  
seleziona il numero di  
riferimento e segui le  
istruzioni.  
For assembly instructions  
scan the QR code, select the  
relevant assembly number  
and follow the instructions.

Ottone

Maniglie



# TIROL



OLV



OCS



OCL



OLV

	OLV	OCS	OCL	Conf. Pz.
1 Q8 P90 Guarnitura Q8 placca patent 90 Lever handle 8mm on key plate 90	55452089001	55452089003	55452089007	1
1 Q8 P70 Guarnitura Q8 placca patent 70 Lever handle 8mm on key plate 70	55452087001	55452087003	55452087007	1
1 Q8 PY85 Guarnitura Q8 placca yale 85 Lever handle 8mm on cyl. plate 85	55452088501	55452088503	55452088507	1
2 Q8 P90RS Guarnitura Q8 placca stretta pat 90 Lever handle 8mm on reduced key plate 90	55452051001	55452051003	55452051007	1
2 Q8 P70RS Guarnitura Q8 placca stretta pat 70 Lever handle 8mm on reduced key plate 70	55452057001	55452057003	55452057007	1
2 Q8 PY85RS Guarnitura Q8 placca stretta yale 85 Lever handle 8mm on reduced cyl. plate 85	55452055001	55452055003	55452055007	1
3 Q8 R Guarnitura Q8 ros. senza bocc. Lever handle 8mm on rose	55452280001	55452280003	55452280007	1
3 Q8 RB Guarnitura Q8 ros./bocc. patent Lever handle 8mm on rose key hole escutcheon	55452281001	55452281003	55452281007	1
3 Q8 RBY Guarnitura Q8 ros./bocc. yale Lever handle 8mm on rose - cyl. hole escutcheon	55452285001	55452285003	55452285007	1
3 Q8 RBWC Guarnitura Q8 ros./bocc. Wc Lever handle 8mm on rose wc hole escutcheon	55452288001	55452288003	55452288007	1
4 Q8 ROC Guarnitura Q8 ros.ovale senza bocc. Lever handle 8mm on oval rose	55452220501	55452220503	55452220507	1
4 Q8 RBOC Guarnitura Q8 ros/boc. ovale patent Lever handle 8mm on oval rose key hole escutcheon	55452221501	55452221503	55452221507	1
4 Q8 RBOYC Guarnitura Q8 ros/boc. ovale Yale Lever handle 8mm on oval rose - cyl. hole escutcheon	55452225501	55452225503	55452225507	1

## PORTA

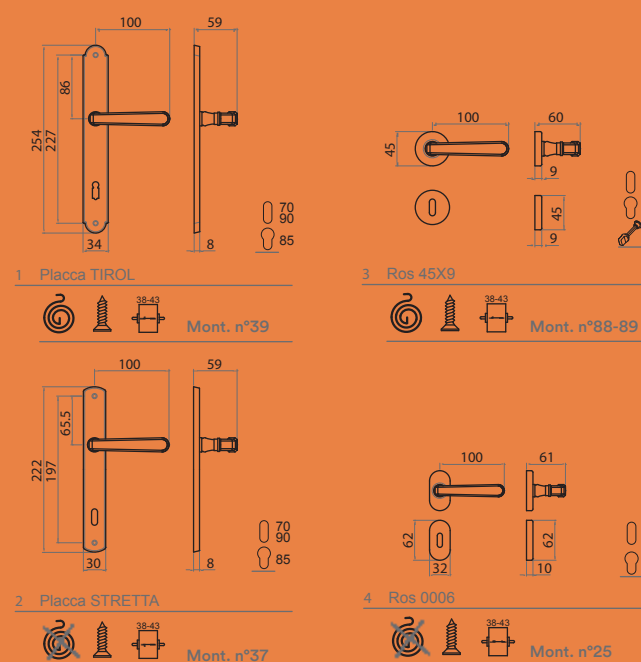

# UNO

55796

Uno

Brass



OLV



OGV



OCL



G-PLUS



OLV



OLV



OLV

Handles

	OLV	OCS	OGV	OCL	Conf. Pz.
1 Q8 P90 Guarnitura Q8 placca patent 90 Lever handle 8mm on key plate 90	55796089001	55796089003	55796089004	55796089007	1
1 Q8 P70 Guarnitura Q8 placca patent 70 Lever handle 8mm on key plate 70	55796087001	55796087003	55796087004	55796087007	1
1 Q8 PY85 Guarnitura Q8 placca yale 85 Lever handle 8mm on cyl. plate 85	55796088501	55796088503	55796088504	55796088507	1
2 Q8 P90RS Guarnitura Q8 placca stretta pat 90 Lever handle 8mm on reduced key plate 90	55796051001	55796051003	55796051004	55796051007	1
2 Q8 P70RS Guarnitura Q8 placca stretta pat 70 Lever handle 8mm on reduced key plate 70	55796057001	55796057003	55796057004	55796057007	1
2 Q8 PY85RS Guarnitura Q8 placca stretta yale 85 Lever handle 8mm on reduced cyl. plate 85	55796055001	55796055003	55796055004	55796055007	1
3 Q8 R Guarnitura Q8 ros. senza bocc. Lever handle 8mm on rose	55796280001	55796280003	55796280004	55796280007	1
3 Q8 RB Guarnitura Q8 ros./bocc. patent Lever handle 8mm on rose key hole escutcheon	55796281001	55796281003	55796281004	55796281007	1
3 Q8 RBY Guarnitura Q8 ros./bocc. yale Lever handle 8mm on rose - cyl. hole escutcheon	55796285001	55796285003	55796285004	55796285007	1
3 Q8 RBWC Guarnitura Q8 ros./bocc. Wc Lever handle 8mm on rose wc hole escutcheon	55796288001	55796288003	55796288004	55796288007	1
4 Q8 ROC Guarnitura Q8 ros.ovale senza bocc. Lever handle 8mm on oval rose	55796220501	55796220503	55796220504	55796220507	1
4 Q8 RBOC Guarnitura Q8 ros/boc. ovale patent Lever handle 8mm on oval rose key hole escutcheon	55796221501	55796221503	55796221504	55796221507	1
4 Q8 RBOYC Guarnitura Q8 ros/boc. ovale Yale Lever handle 8mm on oval rose - cyl. hole escutcheon	55796225501	55796225503	55796225504	55796225507	1
5 CREM/MART SG Cremonese-martellina Q7 senza gioco Window handle without mechanism	55796400001	55796400003	55796400004	55796400007	2
6 DK X 40 Martellina DK Q7 x 40 window handle DK x 40 mm	55796557001	55796557003	55796557004	55796557007	2
6 DK X 40 C/BUSS. Martellina DK Q7 x 40 con bussole D. 9,5 window handle DK x 40mm with pins D.9,5	55796558001	55796558003	55796558004	55796558007	2

55796

Uno

## PORTA

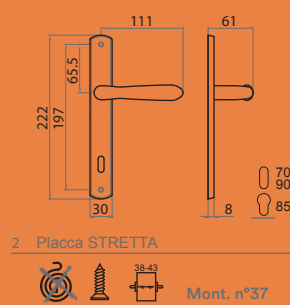
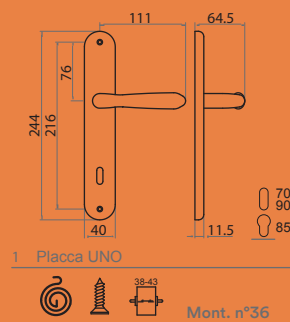

## FINESTRA

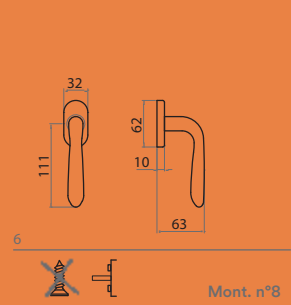
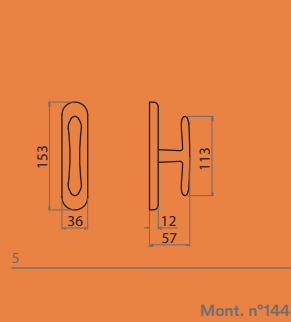
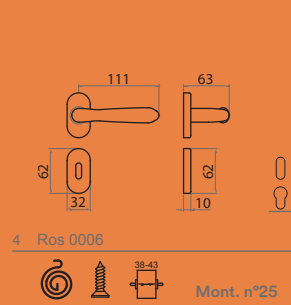
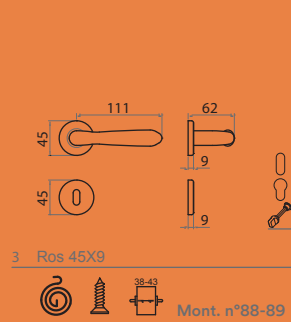

Per istruzioni di montaggio scansiona QR code, seleziona il numero di riferimento e segui le istruzioni.  
For assembly instructions scan the QR code, select the relevant assembly number and follow the instructions.

Ottone

Maniglie

# Alluminio

# Aluminum

170 Introduzione / Introduction  
172 Finiture / Finishes

174 142  
176 143  
178 144  
180 190  
182 239  
184 240  
186 7900  
188 7900  
190 ARCHIMEDE  
192 BRIXIA  
194 CARLO  
196 DELTA  
198 EUROPA 238  
200 GABRY  
202 ITACA 2005  
204 LEONARDO  
206 JOLLY 210  
208 PIGNA 2008  
210 SEVEN  
212 SEVEN Q  
214 SHARK  
216 SUSY - 2040  
218 UNIVERSAL  
220 UNO  
222 2071  
224 2006 CUORE



Aluminium

Handles

**L'alluminio é sicuramente uno dei metalli non ferrosi più interessanti grazie al suo basso peso specifico ed alla sua buona resistenza alla corrosione che viene notevolmente incrementata mediante ossidazione anodica ed ora anche con l'innovativo trattamento GHI.CO.TEC**

**L'alluminio è un materiale responsabile, grazie alla sua capacità di essere riutilizzato all'infinito con un basso consumo energetico, rendendolo fondamentale per un futuro più sostenibile.**

**Aluminium is definitely one of the most interesting non-ferrous metals due to its low specific weight and its strong resistance to corrosion. This feature is considerably increased by means of anodic oxidation and now also by using the innovative GHI.CO.TEC treatment.**

**Aluminum is a responsible material, thanks to its ability to be endlessly reused with low energy consumption, making it essential for a more sustainable future.**



# Finiture alluminio Aluminium finishing



05

04

01

02

03

Aluminium

Handles

F4	01
F9	02
ACP	03
ACS	04
F1	05
ANO	06
GCTOL	07
F3	08
F2	09
F1-SAT	10

07

06

08

09

10

Alluminio

Maniglie

# 142

70142

142

Aluminium



F1



F4

	F1	F3	F4	Conf. Pz.
1 Q8 BIL Coppia maniglie con Q8 (Bilancino) Pair handle with 8mm spindle	70142208001	70142208003	70142208004	10
2 Q8 R 45 Guarnitura Q8 ros. senza bocc. Lever handle 8mm on rose	70142280001	70142280003	70142280004	10
2 Q8 RB 45 Guarnitura Q8 ros./bocc. patent Lever handle 8mm on rose key hole escutcheon	70142281001	70142281003	70142281004	10
2 Q8 RBY 45 Guarnitura Q8 ros./bocc. yale Lever handle 8mm on rose - cyl. hole escutcheon	70142285001	70142285003	70142285004	10
3 Q8 R 50 Guarnitura Q8 ros. senza bocc. Lever handle 8mm on rose	70142230001	70142230003	70142230004	10
3 Q8 RB 50 Guarnitura Q8 ros./bocc. patent Lever handle 8mm on rose key hole escutcheon	70142231001	70142231003	70142231004	10
3 Q8 RBY 50 Guarnitura Q8 ros./bocc. yale Lever handle 8mm on rose - cyl. hole escutcheon	70142235001	70142235003	70142235004	10
4 Q8 RBWC Q6 50 Guarnitura Q8 ros./bocc. Wc Q6 Lever handle 8mm on wc key hole escutcheon 6mm	70142238001	70142238003	70142238004	10

70142

142

## PORTA

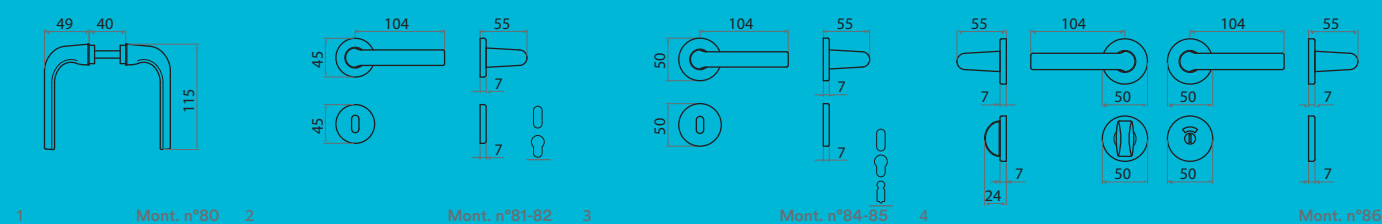

1 Mont. n°80 2 Mont. n°81-82 3 Mont. n°84-85 4 Mont. n°86



Guarnitura senza molla di ritorno - Handle without spring  
Viti non in dotazione - Screws not provided

Alluminio



Per istruzioni di montaggio  
scansiona QR code,  
seleziona il numero di  
riferimento e segui le  
istruzioni.  
For assembly instructions  
scan the QR code, select the  
relevant assembly number  
and follow the instructions.

Maniglie

# 143

70143

143 F4

Aluminum



F1



F4



F9

Handles

	F1	F3	F4	F9	Conf. Pz.
1 Q8 BIL Coppia maniglie con Q8 (Bilancino) Pair handle with 8mm spindle	70143208001	70143208003	70143208004	70143208009	10
2 Q8 R 45 Guarnitura Q8 ros. senza bocc. Lever handle 8mm on rose	70143280001	70143280003	70143280004	70143280009	10
2 Q8 RB 45 Guarnitura Q8 ros./bocc. patent Lever handle 8mm on rose key hole escutcheon	70143281001	70143281003	70143281004	70143281009	10
2 Q8 RBY 45 Guarnitura Q8 ros./bocc. yale Lever handle 8mm on rose - cyl. hole escutcheon	70143285001	70143285003	70143285004	70143285009	10
3 Q8 R 50 Guarnitura Q8 ros. senza bocc. Lever handle 8mm on rose	70143230001	70143230003	70143230004	70143230009	10
3 Q8 RB 50 Guarnitura Q8 ros./bocc. patent Lever handle 8mm on rose key hole escutcheon	70143231001	70143231003	70143231004	70143231009	10
3 Q8 RBY 50 Guarnitura Q8 ros./bocc. yale Lever handle 8mm on rose - cyl. hole escutcheon	70143235001	70143235003	70143235004	70143235009	10
4 Q8 RBWC Q6 50 Guarnitura Q8 ros./bocc. Wc Q6 Lever handle 8mm on wc key hole escutcheon 6mm	70143238001	70143238003	70143238004	70143238009	10

70143

143 F4

## PORTA

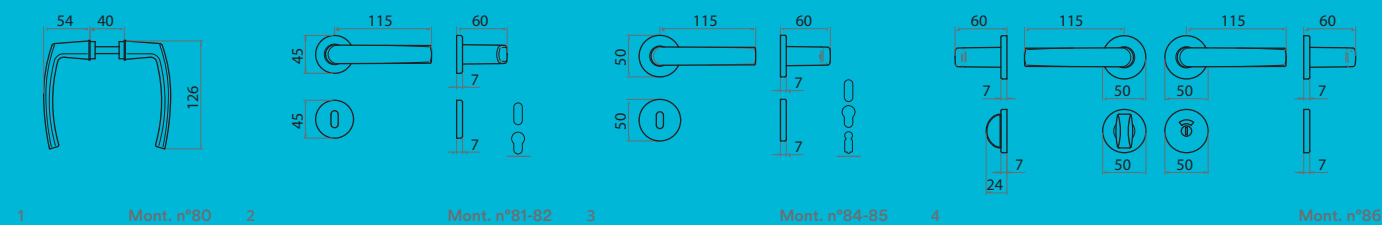

1 Mont. n°80      2 Mont. n°81-82      3 Mont. n°84-85      4 Mont. n°86



Guarnitura senza molla di ritorno - Handle without spring  
Viti non in dotazione - Screws not provided



Per istruzioni di montaggio  
scansiona QR code,  
seleziona il numero di  
riferimento e segui le  
istruzioni.  
For assembly instructions  
scan the QR code, select the  
relevant assembly number  
and follow the instructions.

Alluminio

Maniglie

# 144

70144

144

Aluminum



F1



F4



F9

Handles

	F1	F3	F4	F9	Conf. Pz.
1 Q8 BIL Coppia maniglie con Q8 (Bilancino) Pair handle with 8mm spindle	70144208001	70144208003	70144208004	70144208009	10
2 Q8 R 45 Guarnitura Q8 ros. senza bocc. Lever handle 8mm on rose	70144280001	70144280003	70144280004	70144280009	10
2 Q8 RB 45 Guarnitura Q8 ros./bocc. patent Lever handle 8mm on rose key hole escutcheon	70144281001	70144281003	70144281004	70144281009	10
2 Q8 RBY 45 Guarnitura Q8 ros./bocc. yale Lever handle 8mm on rose - cyl. hole escutcheon	70144285001	70144285003	70144285004	70144285009	10
3 Q8 R 50 Guarnitura Q8 ros. senza bocc. Lever handle 8mm on rose	70144230001	70144230003	70144230004	70144230009	10
3 Q8 RB 50 Guarnitura Q8 ros./bocc. patent Lever handle 8mm on rose key hole escutcheon	70144231001	70144231003	70144231004	70144231009	10
3 Q8 RBY 50 Guarnitura Q8 ros./bocc. yale Lever handle 8mm on rose - cyl. hole escutcheon	70144235001	70144235003	70144235004	70144235009	10
4 Q8 RBWC Q6 50 Guarnitura Q8 ros./bocc. Wc Q6 Lever handle 8mm on wc key hole escutcheon 6mm	70144238001	70144238003	70144238004	70144238009	10

70144

144

## PORTA

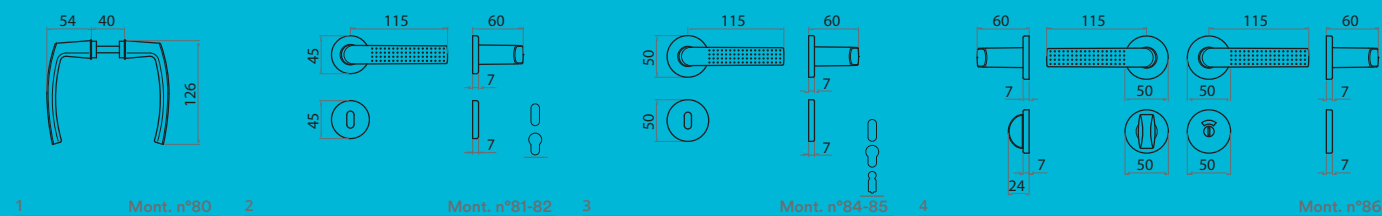

1 Mont. n°80      2 Mont. n°81-82      3 Mont. n°84-85      4 Mont. n°86



Guarnitura senza molla di ritorno - Handle without spring  
Viti non in dotazione - Screws not provided



Per istruzioni di montaggio  
scansiona QR code,  
seleziona il numero di  
riferimento e segui le  
istruzioni.  
For assembly instructions  
scan the QR code, select the  
relevant assembly number  
and follow the instructions.

Alluminio

Maniglie



# 190



F1



F9

	F1	F3	F4	F9	Conf. Pz.
1 Q8 BIL Coppia maniglie con Q8 (Bilancino) Pair handle with 8mm spindle	70190208001	70190208003	70190208004	70190208009	10
2 Q8 R 45 Guarnitura Q8 ros. senza bocc. Lever handle 8mm on rose	70190280001	70190280003	70190280004	70190280009	10
2 Q8 RB 45 Guarnitura Q8 ros./bocc. patent Lever handle 8mm on rose key hole escutcheon	70190281001	70190281003	70190281004	70190281009	10
2 Q8 RBY 45 Guarnitura Q8 ros./bocc. yale Lever handle 8mm on rose - cyl. hole escutcheon	70190285001	70190285003	70190285004	70190285009	10
3 Q8 R 50 Guarnitura Q8 ros. senza bocc. Lever handle 8mm on rose	70190230001	70190230003	70190230004	70190230009	10
3 Q8 RB 50 Guarnitura Q8 ros./bocc. patent Lever handle 8mm on rose key hole escutcheon	70190231001	70190231003	70190231004	70190231009	10
3 Q8 RBY 50 Guarnitura Q8 ros./bocc. yale Lever handle 8mm on rose - cyl. hole escutcheon	70190235001	70190235003	70190235004	70190235009	10
4 Q8 RBWC Q6 50 Guarnitura Q8 ros./bocc. Wc Q6 Lever handle 8mm on wc key hole escutcheon 6mm	70190238001	70190238003	70190238004	70190238009	10

70190

190

## PORTA

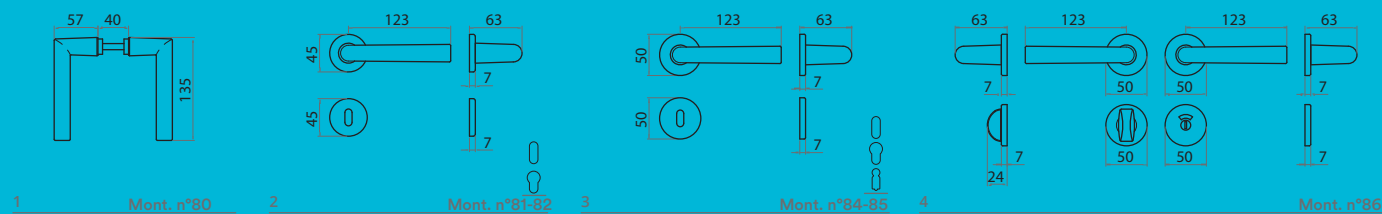

Guarnitura senza molla di ritorno - Handle without spring  
Viti non in dotazione - Screws not provided

Alluminio



Per istruzioni di montaggio  
scansiona QR code,  
seleziona il numero di  
riferimento e segui le  
istruzioni.  
For assembly instructions  
scan the QR code, select the  
relevant assembly number  
and follow the instructions.

Maniglie

# 239

70239

239

Aluminum



F1



F9

	F1	F3	F4	F9	Conf. Pz.
1 Q8 BIL Coppia maniglie con Q8 (Bilancino) Pair handle with 8mm spindle	70239208001	70239208003	70239208004	70239208009	10
2 Q8 R 45 Guarnitura Q8 ros. senza bocc. Lever handle 8mm on rose	70239280001	70239280003	70239280004	70239280009	10
2 Q8 RB 45 Guarnitura Q8 ros./bocc. patent Lever handle 8mm on rose key hole escutcheon	70239281001	70239281003	70239281004	70239281009	10
2 Q8 RBY 45 Guarnitura Q8 ros./bocc. yale Lever handle 8mm on rose - cyl. hole escutcheon	70239285001	70239285003	70239285004	70239285009	10
3 Q8 R 50 Guarnitura Q8 ros. senza bocc. Lever handle 8mm on rose	70239230001	70239230003	70239230004	70239230009	10
3 Q8 RB 50 Guarnitura Q8 ros./bocc. patent Lever handle 8mm on rose key hole escutcheon	70239231001	70239231003	70239231004	70239231009	10
3 Q8 RBY 50 Guarnitura Q8 ros./bocc. yale Lever handle 8mm on rose - cyl. hole escutcheon	70239235001	70239235003	70239235004	70239235009	10
4 Q8 RBWC Q6 50 Guarnitura Q8 ros./bocc. Wc Q6 Lever handle 8mm on wc key hole escutcheon 6mm	70239238001	70239238003	70239238004	70239238009	10

70239

239

## PORTA

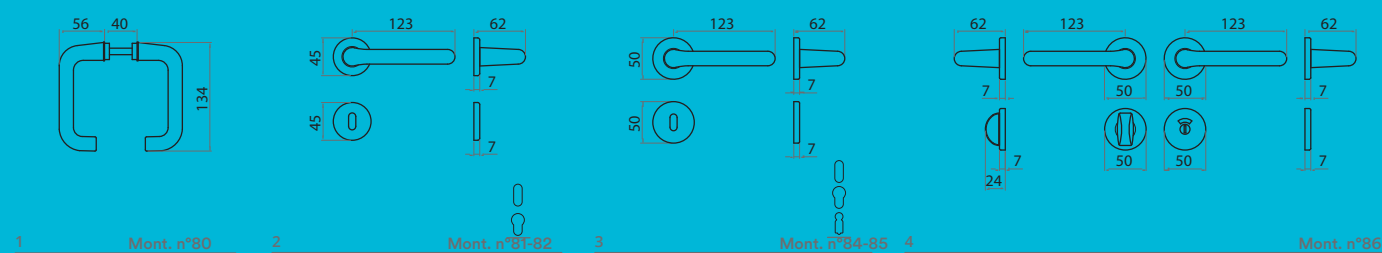

Guarnitura senza molla di ritorno - Handle without spring  
Viti non in dotazione - Screws not provided



Per istruzioni di montaggio  
scansiona QR code,  
seleziona il numero di  
riferimento e segui le  
istruzioni.  
For assembly instructions  
scan the QR code, select the  
relevant assembly number  
and follow the instructions.

Alluminio

Maniglie

# 240

70240

240

Aluminum



F1



GCTOL



F1

		F1	GCTOL	Conf Pz.
1	Q8 RB 50 C/M Guarnitura Q8 ros./bocc.patent con molla Lever handle 8mm on rose springloaded - key hole escutcheon	70240231001	70240231012	1
1	Q8 RBY 50 C/M Guarnitura Q8 ros./bocc. yale Lever handle 8mm on rose springloaded - cyl. hole escutcheon	70240235001	70240235012	1
2	Q8 RBOC C/M Guarnitura Q8 ros./bocc. ovale con molla Lever handle 8mm on oval rose w/spring key hole escutcheon	70240221601	70240221612	1
2	Q8 RBOYC C/M Guarnitura Q8 ros./bocc. ovale yale con molla Lever handle 8mm on oval rose w/spring cylinder key hole escutcheon	70240225601	70240225612	1
3	DK X 40 Martellina DK Q7 x 40 window handle DK x 40 mm	70240557001	70240557012	20
3	DK X 40 C/BUSS. Martellina DK Q7 x 40 con bussole D. 9,5 window handle DK x 40mm with pins D.9,5	70240558001	70240558012	20

70240

## PORTA

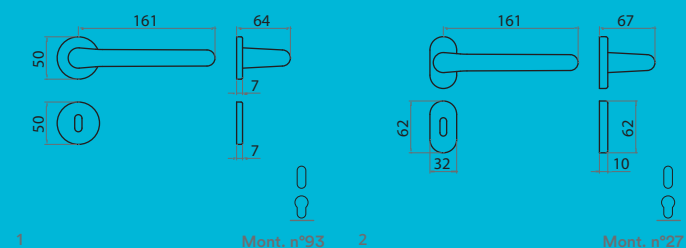

  Guarnitura con molla di ritorno - Handle with spring  
Viti non in dotazione - Screws not provided

240

## FINESTRA

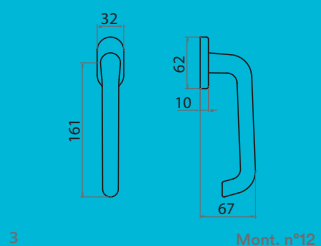

Per istruzioni di montaggio  
scansiona QR code,  
seleziona il numero di  
riferimento e segui le  
istruzioni.  
For assembly instructions  
scan the QR code, select the  
relevant assembly number  
and follow the instructions.

Alluminio

Maniglie

# 7900

77900

7900

Aluminum



F1



F4



F9



F1



F1



F1

Handles

	F1	F3	F4	F9	Conf. Pz.
1 Q8 BIL Coppia maniglie con Q8 (Bilancino) Pair handle with 8mm spindle	77900208001	77900208003	77900208004	77900208009	10
2 Q8 RQ50 Guarnitura Q8 ros. QUADRA senza bocc. Lever handle 8mm on square rose	77900210301	77900210303	77900210304	77900210309	10
2 Q8 RQ50 C/M Guarnitura Q8 ros. QUADRA senza bocc. con molla Lever handle 8mm on square rose spring loaded	77900210501	77900210503	77900210504	77900210509	10
2 Q8 RBQ 50 Guarnitura Q8 ros./bocc. QUADRA patent Lever handle 8mm on square rose key hole escutcheon	77900211301	77900211303	77900211304	77900211309	10
2 Q8 RBQ 50 C/M Guarnitura Q8 ros./bocc. QUADRA patent con molla Lever handle 8mm on square rose key hole escutcheon springloaded	77900211501	77900211503	77900211504	77900211509	10
2 Q8 RBQY 50 Guarnitura Q8 ros./bocc. QUADRA Yale Lever handle 8mm on square rose cyl hole escutcheon	77900215301	77900215303	77900215304	77900215309	10
2 Q8 RBQY 50 C/M Guarnitura Q8 ros./bocc. QUADRA Yale con molla Lever handle 8mm on square rose cyl hole escutcheon springloaded	77900215501	77900215503	77900215504	77900215509	10
3 Q8 RBQWC Q6 50 Guarnitura Q8 ros./bocc. QUADRA Wc Q6 Lever handle 8mm on square rose wc hole escutcheon 6mm	77900218001	77900218003	77900218004	77900218009	10
3 Q8 RBQWC Q6 50 C/M Guarnitura Q8 ros./bocc. QUADRA Wc Q6 con molla Lever handle 8mm on square rose wc hole escutcheon 6mm springloaded	77900218501	77900218503	77900218504	77900218509	10
4 Q8 RRC Guarnitura Q8 ros. RETT. senza bocc. con molla Lever handle 8mm on rectangular rose springloaded	77900280401	77900280403	77900280404	77900280409	10
4 Q8 RBR Guarnitura Q8 ros./bocc. RETT. Patent con molla Lever handle 8mm on springloaded rectangular rose key hole escutcheon	77900281401	77900281403	77900281404	77900281409	10
4 Q8 RBYR Guarnitura Q8 ros./bocc. rett.yale molla dx/sx Lever handle 8mm on rectangular springloaded rose key hole escutcheon	77900285401	77900285403	77900285404	77900285409	10
5 DK40-35 BUS, 9,5 7900 GHTEK DK40-35 BUS, 9,5 window handle DK x 40mm with pins D,9,5	77900583001	77900583003	77900583004	77900583009	20
6 DK X 40 BUS, 9,5 SECURPULL 7900 DK Q7 x 40 BUSS, 9,5 SECURPULL window handle DK x 40 mm with pins D,9,5 SECURPULL	77900575001	77900575003	77900575004	77900575009	20
7 BALCONY DOOR Guarnitura su rosetta bocchetta yale per porta balcone Q7 - viti pas Lever handle 7mm on rectangular rose key hole escutcheon with metric-thread screw	77900217301	77900217301	77900217304	77900217309	

77900

7900

## PORTA

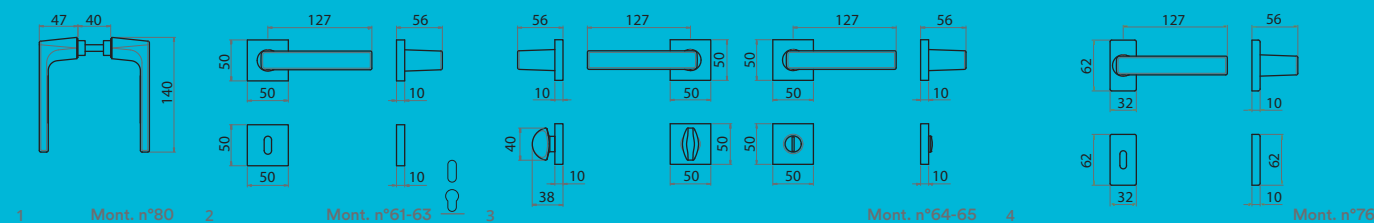

Guarnitura senza molla di ritorno - Handle without spring  
Viti non in dotazione - Screws not provided

## FINESTRA

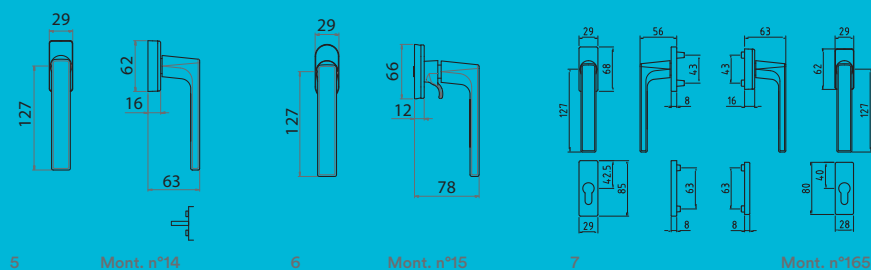

Per istruzioni di montaggio scansiona QR code, seleziona il numero di riferimento e segui le istruzioni.  
For assembly instructions scan the QR code, select the relevant assembly number and follow the instructions.

Alluminio

Maniglie



# 7900

77900

7900

Aluminum



F1-SAT



GCTOL



ANO



RAL9010

Handles



F1



F1



F1



# ARCHIMEDE

77696

Archimede

Aluminum



F1-SAT



Handles

	F1-SAT	Conf. Pz.
1 Q8 RBQ Guarnitura Q8 ros./bocc. patent Lever handle 8mm on rose key hole escutcheon	77696211333	1
2 Q8 RBQY Guarnitura Q8 ros./bocc. yale Lever handle 8mm on rose - cyl. hole escutcheon	77696215333	1
2 Q8 RBWCQ Guarnitura Q8 ros./bocc. Wc Lever handle 8mm on rose wc hole escutcheon	77696218333	1
2 DK x 40 Martellina DK Q7 x 40 window handle DK x 40 mm	77696555033	2
2 DK X 40 C/BUS Martellina DK Q7 x 40 con bussole D. 9,5 window handle DK x 40mm with pins D.9,5	77696556033	2

77696

Archimede

## PORTA

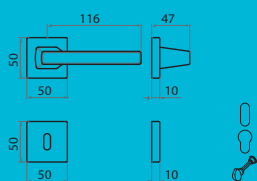

1 Ros 50x50x10 ALL



## FINESTRA

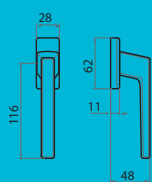

2 DK-3P

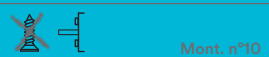

Per istruzioni di montaggio  
scansiona QR code,  
seleziona il numero di  
riferimento e segui le  
istruzioni.  
For assembly instructions  
scan the QR code, select the  
relevant assembly number  
and follow the instructions.

Alluminio

Maniglie

# BRIXIA

77438

Brixia

Aluminum



F1



F4



F9



F1



F1

Handles



# CARLO

77502

Carlo

Aluminum



F1



F4



F9



BIANCO/WHITE



NERO/BLACK



F4



F4



F4



F1

Handles



Per istruzioni di montaggio  
scansiona QR code,  
seleziona il numero di  
riferimento e segui le  
istruzioni.  
For assembly instructions  
scan the QR code, select the  
relevant assembly number  
and follow the instructions.

	F1	F4	F9	ANO	RAL9016	Conf. Pz.
1 Q8 BIL Coppia maniglie con Q8 (Bilancino) Pair handle with 8mm spindle	77502208001	77502208004	77502208009	77502208016	77502208080	10
2 Q8 RQ 45X45X10 Guarnitura Q8 ros. QUADRA senza bocc. Lever handle 8mm on square rose	77502240001	77502240004	77502240009	77502240016	77502240080	10
2 Q8 RQ 45X45X10 C/M Guarnitura Q8 ros. QUADRA senza bocc. con molla Lever handle 8mm on square rose springloaded	77502240501	77502240504	77502240509	77502240516	77502240580	10
2 Q8 RBQ 45X45X10 Guarnitura Q8 ros./bocc. QUADRA patent Lever handle 8mm on square rose key hole escutcheon	77502241001	77502241004	77502241009	77502241016	77502241080	10
2 Q8 RBQ 45X45X10 C/M Guarnitura Q8 ros./bocc. QUADRA patent con molla Lever handle 8mm on square rose key hole escutcheon springloaded	77502241501	77502241504	77502241509	77502241516	77502241580	10
2 Q8 RBQY 45X45X10 Guarnitura Q8 ros./bocc. QUADRA Yale Lever handle 8mm on square rose cyl hole escutcheon	77502245001	77502245004	77502245009	77502245016	77502245080	10
2 Q8 RBQY 45X45X10 C/M Guarnitura Q8 ros./bocc. QUADRA Yale con molla Lever handle 8mm on square rose cyl hole escutcheon springloaded	77502245501	77502245504	77502245509	77502245516	77502245580	10
3 Q8 RBR Guarnitura Q8 ros./bocc. RETT. patent Lever handle 8mm on springloaded rect rose key hole esc	77502281401	77502281404	77502281409	77502281416	77502281480	10
3 Q8 RBYR Guarnitura Q8 ros./bocc. rett.yale molla dx/sx Lever handle 8mm on springloaded rect rose - cyl. hole esc	77502285401	77502285404	77502285409	77502285416	77502285480	10
4 Q8 RBQWC Q6 45X45X10 Guarnitura Q8 ros./bocc. QUADRA Wc Q6 Lever handle 8mm on square rose wc hole escutcheon 6mm	77502248001	77502248004	77502248009	77502248016	77502248080	10
4 Q8 RBQWC Q6 45X45X10 C/M Guarnitura Q8 ros./bocc. QUADRA Wc Q6 con molla Lever handle 8mm on square rose wc hole escutcheon 6mm springloaded	77502248501	77502248504	77502248509	77502248516	77502248580	10
5 DK X 35 C/BUSS D.9,5 CARLO DKX35 8SC RET BUS.9,5 window handle DK x 35mm with pins D.9,5	7750255650108	7750255650408	7750255650908	7750255651608	7750255658008	100
5 DK X 40 C/BUSS D.9,5 CARLO DK Q7 x 40 con bussole D. 9,5 window handle DK x 40mm with pins D.9,5	7750255600108	7750255600408	7750255600908	7750255601608	7750255608008	20
5 DK X 45 C/BUSS D.9,5 CARLO DKX45 8SC RET BUS.9,5 window handle DK x 45mm with pins D.9,5	7750255640108	7750255640408	7750255640908	7750255641608	7750255648008	100
5 DK X 50 C/BUSS D.9,5 CARLO DKX50 8SC RET BUS.9,5 window handle DK x 50mm with pins D.9,5	7750255660108	7750255660408	7750255660908	7750255661608	7750255668008	100
6 DK X 40 C/BUSS D.9,5 CARLO con pulsante DK Q7 x 40 con bussole D. 9,5 window handle DK x 40mm with pins D.9,5	77502562501	77502562504	77502562509	77502562516	77502562580	5
7 DK X 45 C/BUSS D.9,5 CARLO con chiave DK Q7 x 45 con bussole D. 9,5 window handle DK x 45mm with pins D.9,5	77502563301	77502563304	77502563309	77502563316	77502563380	5
7 DK X 40 C/BUSS D.9,5 CARLO con chiave DK Q7 x 40 con bussole D. 9,5 window handle DK x 40mm with pins D.9,5	77502563501	77502563504	77502563509	77502563516	77502563580	5
8 BALCONY DOOR G.ra ros bocc yale per porta balcone Q7 - viti pass Lever handle 7mm on rect rose key hole esc metric-thread screw	77502217301	77502217304	77502217309	77502217316	77502217380	
9 BALCONY DOOR G.ra ros bocc yale per porta balcone Q7 - viti pass Lever handle 7mm on rect rose key hole esc metric-thread screw	77502217501	77502217504	77502217509	77502217516	77502217580	

## PORTA

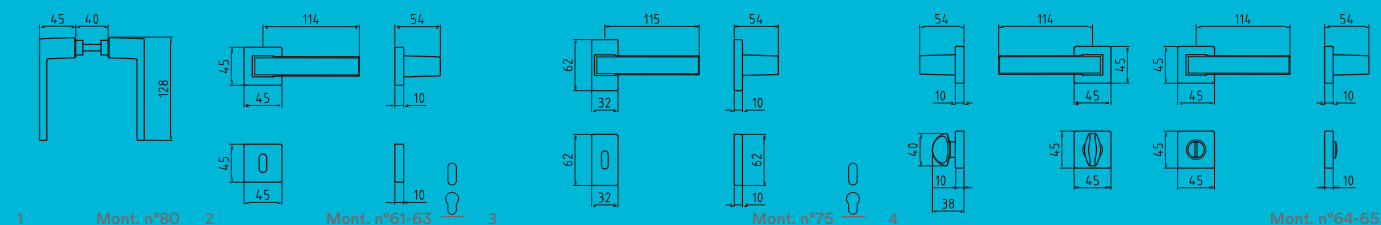

## FINESTRA

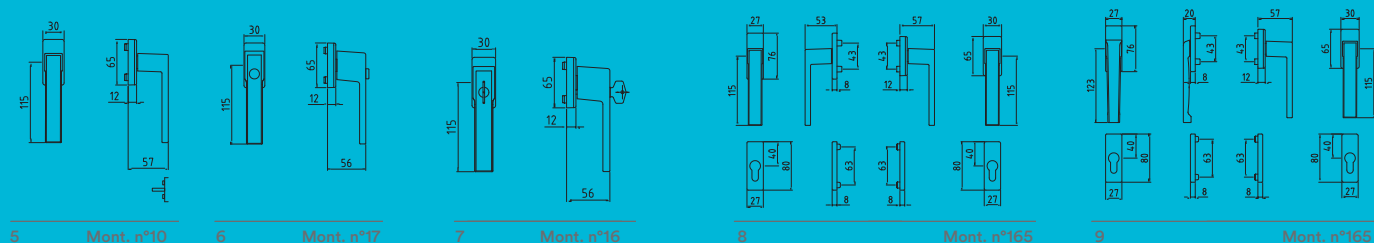



# DELTA

77210

Delta

Aluminum



F1



F4



F9



F41

Handles

	F1	F3	F4	RAL9010	F9	ANO	Conf. Pz.
1 Q8 BIL Coppia maniglie con Q8 (Bilancino) Pair handle with 8mm spindle	77210208001	77210208003	77210208004	77210208007	77210208009	77210208016	10
2 Q8 RQ 50 Guarnitura Q8 ros. QUADRA senza bocc. Lever handle 8mm on square rose	77210210301	77210210303	77210210304	77210210307	77210210309	77210210316	10
2 Q8 RBQ 50 Guarnitura Q8 ros./bocc. QUADRA patent Lever handle 8mm on square rose key hole escutcheon	77210211301	77210211303	77210211304	77210211307	77210211309	77210211316	10
2 Q8 RBQY 50 Guarnitura Q8 ros./bocc. QUADRA Yale Lever handle 8mm on square rose cyl hole escutcheon	77210215301	77210215303	77210215304	77210215307	77210215309	77210215316	10
3 Q8 RBQWC Guarnitura Q8 ros./bocc. QUADRA Wc Q6 Lever handle 8mm on square rose wc hole escutcheon 6mm	77210218001	77210218003	77210218004	77210218007	77210218009	77210218016	10
3 DK x 45 C/BUSS D.9,5 DELTA DK X 45 C/BUSS D.9,5 window handle DK x 45 mm with pins D.9,5	7721055600158	7721055600358	7721055600458	7721055600758	7721055600958	7721055601658	100
4 DK X 45 BUS. 9,5 GHTECH DELTA DK X 45 BUS. 9,5 GHTECH window handle DK x 45 mm with pins D.9,5 GHTECH	77210583001	77210583003	77210583004	77210583007	77210583009	77210583016	10

77210

Delta

## PORTA

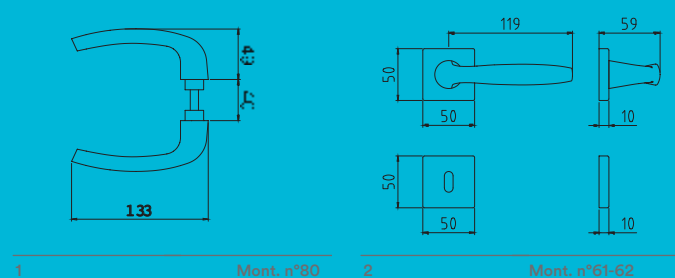

## FINESTRA

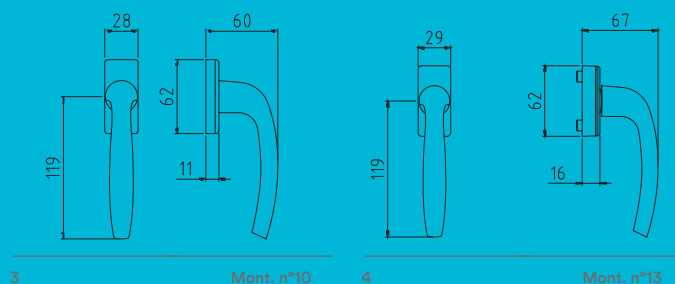

Per istruzioni di montaggio  
scansiona QR code,  
seleziona il numero di  
riferimento e segui le  
istruzioni.  
For assembly instructions  
scan the QR code, select the  
relevant assembly number  
and follow the instructions.

Alluminio

Maniglie

# EUROPA 238

70238

Europa

Aluminium



F1



F4



F9

Handles



F4

	F1	F3	F4	F9	Conf. Pz.
1 Q8 BIL Coppia maniglie con Q8 (Bilancino) Pair handle with 8mm spindle	70238208001	70238208003	70238208004	70238208009	10
2 Q8 P90 Guarnitura Q8 placca patent 90 Lever handle 8mm on key plate 90	70238089001	70238089003	70238089004	70238089009	10
2 Q8 P70 Guarnitura Q8 placca patent 70 Lever handle 8mm on key plate 70	70238087001	70238087003	70238087004	70238087009	10
2 Q8 PY85 Guarnitura Q8 placca yale 85 Lever handle 8mm on cyl. plate 85	70238088501	70238088503	70238088504	70238088509	10
3 Q8 R 45 Guarnitura Q8 ros. senza bocc. Lever handle 8mm on rose	70238280001	70238280003	70238280004	70238280009	10
3 Q8 RB 45 Guarnitura Q8 ros./bocc. patent Lever handle 8mm on rose key hole escutcheon	70238281001	70238281003	70238281004	70238281009	10
3 Q8 RBY 45 Guarnitura Q8 ros./bocc. yale Lever handle 8mm on rose - cyl. hole escutcheon	70238285001	70238285003	70238285004	70238285009	10
4 Q8 R 50 Guarnitura Q8 ros. senza bocc. Lever handle 8mm on rose	70238230001	70238230003	70238230004	70238230009	10
4 Q8 RB 50 Guarnitura Q8 ros./bocc. patent Lever handle 8mm on rose key hole escutcheon	70238231001	70238231003	70238231004	70238231009	10
4 Q8 RBY 50 Guarnitura Q8 ros./bocc. yale Lever handle 8mm on rose - cyl. hole escutcheon	70238235001	70238235003	70238235004	70238235009	10
5 Q8 RBWC Q6 50 Guarnitura Q8 ros./bocc. Wc Q6 Lever handle 8mm on wc. key hole escutcheon 6mm	70238238001	70238238003	70238238004	70238238009	10
6 DKx33 8SC BUS. 9,5 4038 DKx33 8SC BUS. 9,5 window handle DK x 33mm with pins D.9,5	7403855830158	7403855830358	7403855830458	7403855830958	100
6 DKx35 8SC BUS. 9,5 4038 DKx35 8SC BUS. 9,5 window handle DK x 35mm with pins D.9,5	7403855850158	7403855850358	7403855850458	7403855850958	100
6 DKx40 8SC BUS. 9,5 4038 DKx40 8SC BUS. 9,5 window handle DK x 40mm with pins D.9,5	7403855800158	7403855800358	7403855800458	7403855800958	100
6 DKx45 8SC BUS. 9,5 4038 DKx45 8SC BUS. 9,5 window handle DK x 45mm with pins D.9,5	7403855840158	7403855840358	7403855840458	7403855840958	100

70238

Europa

## PORTA

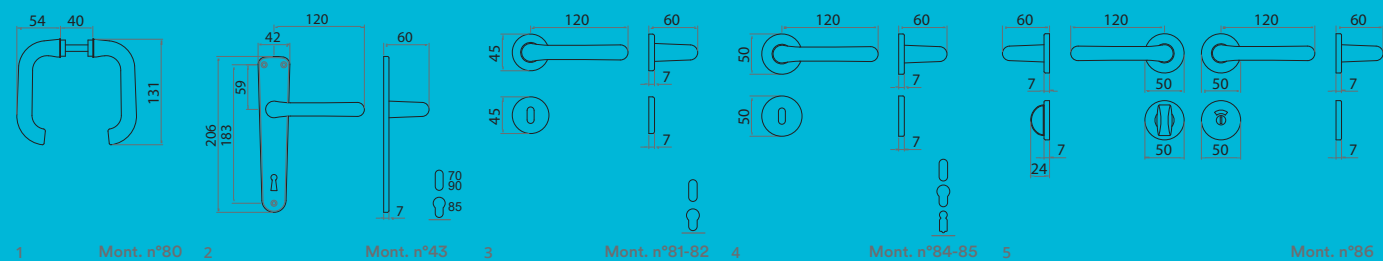

1 Mont. n°80 2 Mont. n°43 3 Mont. n°81-82 4 Mont. n°84-85 5 Mont. n°86

Guarnitura senza molla di ritorno - Handle without spring  
Viti non in dotazione - Screws not provided

## FINESTRA

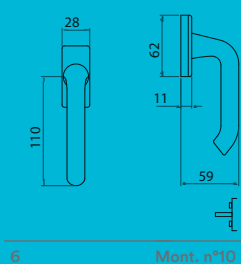

6 Mont. n°10



Per istruzioni di montaggio  
scansiona QR code,  
seleziona il numero di  
riferimento e segui le  
istruzioni.  
For assembly instructions  
scan the QR code, select the  
relevant assembly number  
and follow the instructions.

Alluminio

Maniglie

# GABRY

77400

Gabry

Aluminum



F1



F4



F4

Handles

	F1	F3	F4	Conf. Pz.
1 Q8 BIL Coppia maniglie con Q8 (Bilancino) Pair handle with 8mm spindle	77400208001	77400208003	77400208004	10
2 Q8 P90 Guarnitura Q8 placca patent 90 Lever handle 8mm on key plate 90	77400089001	77400089003	77400089004	10
2 Q8 P70 Guarnitura Q8 placca patent 70 Lever handle 8mm on key plate 70	77400087001	77400087003	77400087004	10
2 Q8 PY85 Guarnitura Q8 placca yale 85 Lever handle 8mm on cyl. plate 85	77400088501	77400088503	77400088504	10
2 Q8 P90 fissa Guarnitura Q8 placca patent 90 fissa Lever handle 8mm on fixed key plate 90	7740008900153	7740008900353	7740008900453	10
2 Q8 P70 fissa Guarnitura Q8 placca patent 70 fissa Lever handle 8mm on key plate 70	7740008700153	7740008700353	7740008700453	10
2 Q8 PY85 fissa Guarnitura Q8 placca yale 85 fissa Lever handle 8mm on fixed cylinder plate 85 packing 50 pairs	7740008850153	7740008850353	7740008850453	10
3 Q8 R 45 Guarnitura Q8 ros. senza bocc. Lever handle 8mm on rose	77400280001	77400280003	77400280004	10
3 Q8 RB 45 Guarnitura Q8 ros./bocc. patent Lever handle 8mm on rose key hole escutcheon	77400281001	77400281003	77400281004	10
3 Q8 RBY 45 Guarnitura Q8 ros./bocc. yale Lever handle 8mm on rose - cyl. hole escutcheon	77400285001	77400285003	77400285004	10
4 Q8 R 50 Guarnitura Q8 ros. senza bocc. Lever handle 8mm on rose	77400230001	77400230003	77400230004	10
4 Q8 RB 50 Guarnitura Q8 ros./bocc. patent Lever handle 8mm on rose key hole escutcheon	77400231001	77400231003	77400231004	10
4 Q8 RBY 50 Guarnitura Q8 ros./bocc. yale Lever handle 8mm on rose - cyl. hole escutcheon	77400235001	77400235003	77400235004	10
5 Q8 RBWC Q6 50 Guarnitura Q8 ros./bocc. Wc Q6 Lever handle 8mm on wc key hole escutcheon 6mm	77400238001	77400238003	77400238004	10
6 DK X 33 C/BUSS D.9,5 GABRY TN DKx33 RETT BUS window handle DK x 33mm with pins D.9,5	7740055600158	7740055600358	7740055600458	100
6 DK X 35 C/BUSS D.9,5 GABRY TN DKx35 RETT BUS window handle DK x 35mm with pins D.9,5	7740055650158	7740055650358	7740055650458	100
6 DK X 40 C/BUSS D.9,5 GABRY TN DKx40 RETT BUS window handle DK x 40mm with pins D.9,5	7740055630158	7740055630358	7740055630458	100
6 DK X 45 C/BUSS D.9,5 GABRY TN DKx45 RETT BUS window handle DK x 45mm with pins D.9,5	7740055640158	7740055640358	7740055640458	100

## PORTA

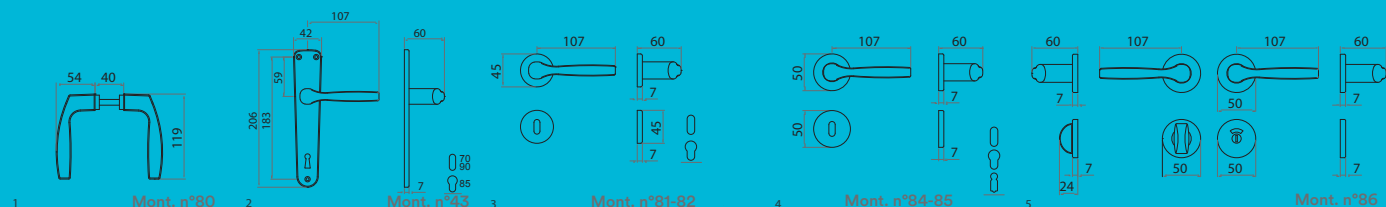

## FINESTRA

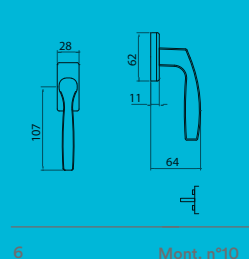

Per istruzioni di montaggio scansiona QR code, seleziona il numero di riferimento e segui le istruzioni.  
For assembly instructions scan the QR code, select the relevant assembly number and follow the instructions.

# ITACA 2005



F1



F4



F9



F4



F1



F1



Per istruzioni di montaggio  
scansiona QR code,  
seleziona il numero di  
riferimento e segui le  
istruzioni.  
For assembly instructions  
scan the QR code, select the  
relevant assembly number  
and follow the instructions.

		F1	F3	F4	F9	Conf. Pz.
1	Q8 BIL Coppia maniglie con Q8 (Bilancino) Pair handle with 8mm spindle	72005208001	72005208003	72005208004	72005208009	10
2	Q8 P90 Guarnitura Q8 placca patent 90 Lever handle 8mm on key plate 90	72005089001	72005089003	72005089004	72005089009	10
2	Q8 P70 Guarnitura Q8 placca patent 70 Lever handle 8mm on key plate 70	72005087001	72005087003	72005087004	72005087009	10
2	Q8 PY85 Guarnitura Q8 placca yale 85 Lever handle 8mm on cyl. plate 85	72005088501	72005088503	72005088504	72005088509	10
3	Q8 R 45 Guarnitura Q8 ros. senza bocc. Lever handle 8mm on rose	72005280001	72005280003	72005280004	72005280009	10
3	Q8 RB 45 Guarnitura Q8 ros./bocc. patent Lever handle 8mm on rose key hole escutcheon	72005281001	72005281003	72005281004	72005281009	10
3	Q8 RBY 45 Guarnitura Q8 ros./bocc. yale Lever handle 8mm on rose - cyl. hole escutcheon	72005285001	72005285003	72005285004	72005285009	10
4	Q8 R 50 Guarnitura Q8 ros. senza bocc. Lever handle 8mm on rose	72005230001	72005230003	72005230004	72005230009	10
4	Q8 RB 50 Guarnitura Q8 ros./bocc. patent Lever handle 8mm on rose key hole escutcheon	72005231001	72005231003	72005231004	72005231009	10
4	Q8 RBY 50 Guarnitura Q8 ros./bocc. yale Lever handle 8mm on rose - cyl. hole escutcheon	72005235001	72005235003	72005235004	72005235009	10
5	Q8 RBWC Q6 50 Guarnitura Q8 ros./bocc. Wc Q6 Lever handle 8mm on wc key hole escutcheon 6mm	72005238001	72005238003	72005238004	72005238009	10
6	DK X 33 C/BUSS D.9,5 ITACA DKX33 BUS window handle DK x 33mm with pins D.9,5	7200555830158	7200555830358	7200555830458	7200555830958	100
6	DK X 35 C/BUSS D.9,5 ITACA DKX35 BUS window handle DK x 35mm with pins D.9,5	7200555850158	7200555850358	7200555850458	7200555850958	100
6	DK X 40 C/BUSS D.9,5 ITACA DKX40 BUS window handle DK x 40mm with pins D.9,5	7200555800158	7200555800358	7200555800458	7200555800958	100
6	DK X 45 C/BUSS D.9,5 ITACA DKX45 BUS window handle DK x 45mm with pins D.9,5	7200555840158	7200555840358	7200555840458	7200555840958	100
7	DK X 40 SECURPULL ITACA SECURPULL DK40 window handle DK x 40mm SECURPULL	72005575001	72005575003	72005575004	72005575009	20
8	DK X 40-35 GHTECH ITACA GHTEK DK40-35 window handle DK x 40mm GHTECH	72005574001	72005574003	72005574004	72005574009	20
9	BALCONY DOOR G.ra ros bocc yale per porta balcone Q7 - viti pass Lever handle 7mm on rect rose key hole esc metric-thread screw	72005227301	72005227303	72005227304	72005227309	

## PORTA

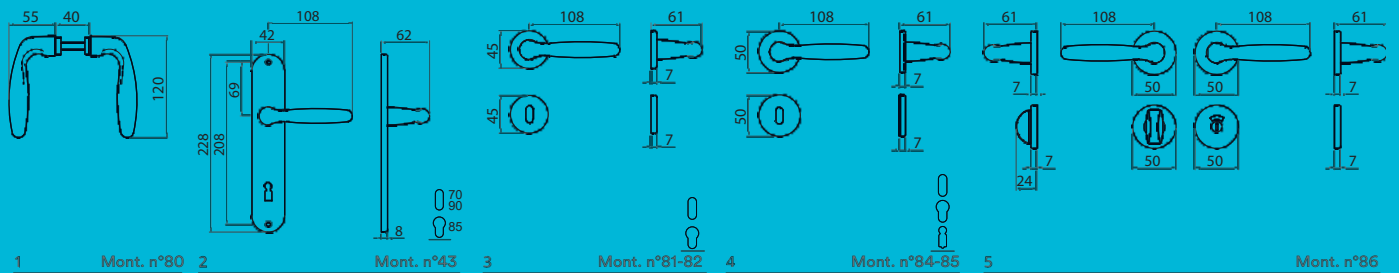

Guarnitura senza molla di ritorno - Handle without spring  
Viti non in dotazione - Screws not provided

## FINESTRA

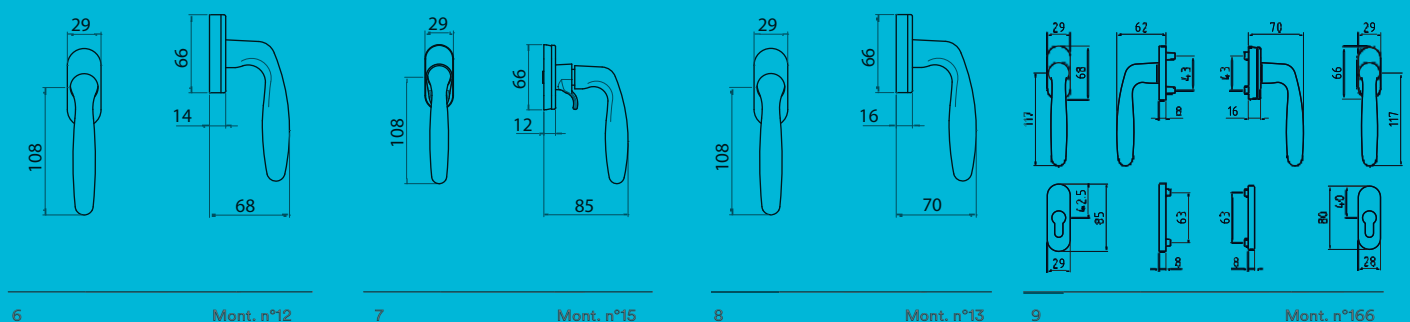



# LEONARDO

DESIGN FABRIZIO BIANCHETTI

DESIGN FOR ALL

77042

Leonardo

Aluminium



ACL



ANO



ACP

Handles



Per istruzioni di montaggio  
scansiona QR code,  
seleziona il numero di  
riferimento e segui le  
istruzioni.  
For assembly instructions  
scan the QR code, select the  
relevant assembly number  
and follow the instructions.

	ACP	ANO	ACL	Conf. Pz.
1 Q8 R Guarnitura Q8 ros. senza bocc. Lever handle 8mm on rose	77042280013	77042280016	77042280017	1
1 Q8 RB Guarnitura Q8 ros./bocc. patent Lever handle 8mm on rose key hole escutcheon	77042281013	77042281016	77042281017	1
1 Q8 RBY Guarnitura Q8 ros./bocc. yale Lever handle 8mm on rose - cyl. hole escutcheon	77042285013	77042285016	77042285017	1
1 Q8 RBWC Guarnitura Q8 ros./bocc. Wc Lever handle 8mm on rose wc hole escutcheon	77042288013	77042288016	77042288017	1
2 Q8 ROC Guarnitura Q8 ros.ovale senza bocc. Lever handle 8mm on oval rose	77042220513	77042220516	77042220517	1
2 Q8 RBOC Guarnitura Q8 ros/boc. ovale patent Lever handle 8mm on oval rose key hole escutcheon	77042221513	77042221516	77042221517	1
2 Q8 RBOYC Guarnitura Q8 ros/boc. ovale Yale Lever handle 8mm on oval rose - cyl. hole escutcheon	77042225513	77042225516	77042225517	1

77042

Leonardo

Il Progetto Leonardo rinnova il rapporto con l'oggetto maniglia indirizzandolo verso un uso ampliato realmente utilizzabile da bambini, adulti, anziani o persone con sedia a ruote. Un disegno semplice e "voluminoso" determina con eleganza le forme della maniglia e consente l'impugnarla a diverse altezze. Una forma innovativa e gradevole risolve i temi dell'accessibilità e della praticità d'uso senza barriere formali o psicologiche.

Design for all = utenza universale

Il mondo della progettazione si è sempre rivolto ad un modello ideale di utente (ipotizzato già negli studi dell'uomo vitruviano di Leonardo e sino in tempi più recenti dal Modulor di Le Corbusier): un uomo di età media, di buona costituzione fisica che non ammette varianti. Il mondo reale invece è abitato da bambini, giovani, adulti ed anziani, pertanto anche senza tener conto di disabilità gravi l'utente reale non è in grado di usufruire a pienamente ed in modo autonomo le strutture ed i prodotti che la società gli offre. L'uomo di Leonardo non è superato ma deve essere integrato seguendo l'evoluzione di una società che è più attenta alle esigenze di un design for all e cioè universale (per tutti gli utenti). Il progetto deve quindi rivolgersi verso un'utenza più ampia per soddisfare senza barriere fisiche o psicologiche le diverse esigenze abitative di una società reale. La normativa vigente in tema di accessibilità prevede che le maniglie delle porte, solitamente applicate dalla produzione di serie a 105 cm, sia collocata ad altezza 90 cm. Con la maniglia Leonardo si ha la possibilità di impugnare la maniglia a diverse altezze.

Dfa Italia (Design for All Italia, membro di EIDD - Design for All Europe) ha assegnato alla maniglia Leonardo il prestigioso marchio di qualità Dfa.

The Leonardo Project takes a new look at our relationship with the handle as an object aimed at a wide range of uses. It really can be used by children, adults, old people and people in wheelchairs. A simple, voluminous design determines the elegant shape of the handle and makes it possible to grip it at different heights. An innovative and pleasing shape answers the need for accessibility and ease of use without formal or psychological barriers.

Dfa Italy (Design for All Italy, member of EIDD - Design for all Europe) has assigned to Leonardo handle the prestigious DFA quality marks for its ability to be used by the largest category of users without placing functional or psychological barriers.

#### PORTA

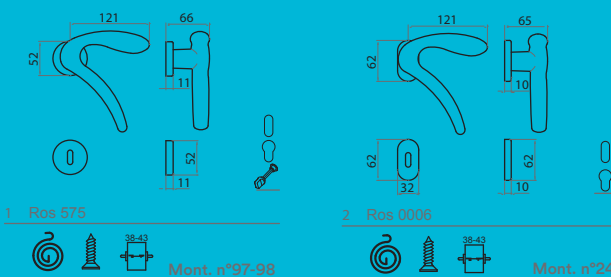

Alluminio

Maniglie

# JOLLY 210

70210

Jolly

Aluminum



F1



F4

	F1	F3	F4	Conf. Pz.
1 Q8 BIL Coppia maniglie con Q8 (Bilancino) Pair handle with 8mm spindle	70210208001	70210208003	70210208004	10
2 Q8 P90 Guarnitura Q8 placca patent 90 Lever handle 8mm on key plate 90	70210089001	70210089003	70210089004	10
2 Q8 P70 Guarnitura Q8 placca patent 70 Lever handle 8mm on key plate 70	70210087001	70210087003	70210087004	10
2 Q8 PY85 Guarnitura Q8 placca yale 85 Lever handle 8mm on cyl. plate 85	70210088501	70210088503	70210088504	10
3 Q8 R 45 Guarnitura Q8 ros. senza bocc. Lever handle 8mm on rose	70210280001	70210280003	70210280004	10
3 Q8 RB 45 Guarnitura Q8 ros./bocc. patent Lever handle 8mm on rose key hole escutcheon	70210281001	70210281003	70210281004	10
3 Q8 RBY 45 Guarnitura Q8 ros./bocc. yale Lever handle 8mm on rose - cyl. hole escutcheon	70210285001	70210285003	70210285004	10
4 Q8 R 50 Guarnitura Q8 ros. senza bocc. Lever handle 8mm on rose	70210230001	70210230003	70210230004	10
4 Q8 RB 50 Guarnitura Q8 ros./bocc. patent Lever handle 8mm on rose key hole escutcheon	70210231001	70210231003	70210231004	10
4 Q8 RBY 50 Guarnitura Q8 ros./bocc. yale Lever handle 8mm on rose - cyl. hole escutcheon	70210235001	70210235003	70210235004	10
5 Q8 RBWC Q6 50 Guarnitura Q8 ros./bocc. Wc Q6 Lever handle 8mm on wc key hole escutcheon 6mm	70210238001	70210238003	70210238004	10

70210

Jolly

## PORTA

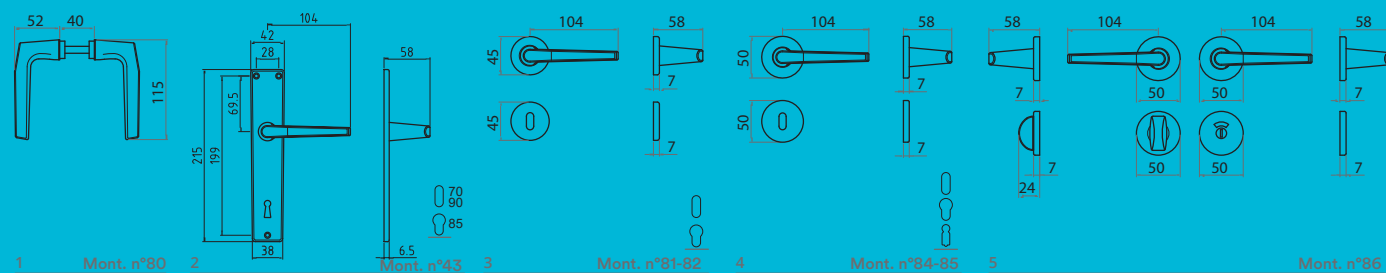

  Guarnitura senza molla di ritorno - Handle without spring  
Viti non in dotazione - Screws not provided

Alluminio



Per istruzioni di montaggio  
scansiona QR code,  
seleziona il numero di  
riferimento e segui le  
istruzioni.  
For assembly instructions  
scan the QR code, select the  
relevant assembly number  
and follow the instructions.

Maniglie

# PIGNA 2008

72008

Pigna 2008

Aluminum



F1



F4



F1-SAT



F9



GCTOS



GCTOL

Handles

	F1	F3	F4	F9	Conf. Pz.
1 Q8 BIL Coppia maniglie con Q8 (Bilancino) Pair handle with 8mm spindle	72008208001	72008208003	72008208004	72008208009	10
2 Q8 R 45 Guarnitura Q8 ros. senza bocc. Lever handle 8mm on rose	72008280001	72008280003	72008280004	72008280009	10
2 Q8 RB 45 Guarnitura Q8 ros./bocc. patent Lever handle 8mm on rose key hole escutcheon	7200	72008281003	72008281004	72008281009	10
2 Q8 RBY 45 Guarnitura Q8 ros./bocc. yale Lever handle 8mm on rose - cyl. hole escutcheon	72008285001	72008285003	72008285004	72008285009	10
3 Q8 R 50 Guarnitura Q8 ros. senza bocc. Lever handle 8mm on rose	72008230001	72008230003	72008230004	72008230009	10
3 Q8 RB 50 Guarnitura Q8 ros./bocc. patent Lever handle 8mm on rose key hole escutcheon	72008231001	72008231003	72008231004	72008231009	10
3 Q8 RBY 50 Guarnitura Q8 ros./bocc. yale Lever handle 8mm on rose - cyl. hole escutcheon	72008235001	72008235003	72008235004	72008235009	10
4 Q8 RBWC Q6 50 Guarnitura Q8 ros./bocc. Wc Q6 Lever handle 8mm on wc key hole escutcheon 6mm	72008238001	72008238003	72008238004	72008238009	10

	GCTOL	GCTOS	F1-SAT	Conf. Pz.
2 Q8 R Guarnitura Q8 ros. senza bocc. Lever handle 8mm on rose	77450280012	77450280023	77450280033	1
2 Q8 RB Guarnitura Q8 ros./bocc. patent Lever handle 8mm on rose key hole escutcheon	77450281012	77450281023	77450281033	1
2 Q8 RBY Guarnitura Q8 ros./bocc. yale Lever handle 8mm on rose - cyl. hole escutcheon	77450285012	77450285023	77450285033	1
5 Q8 ROC Guarnitura Q8 ros.ovale senza bocc. Lever handle 8mm on oval rose	77450220512	77450220523	77450220533	1
5 Q8 RBOC Guarnitura Q8 ros/boc. ovale patent Lever handle 8mm on oval rose key hole escutcheon	77450221512	77450221523	77450221533	1
5 Q8 RBOY Guarnitura Q8 ros/boc. ovale yale Lever handle 8mm on oval rose - cyl. hole escutcheon	77450225512	77450225523	77450225533	1

## PORTA

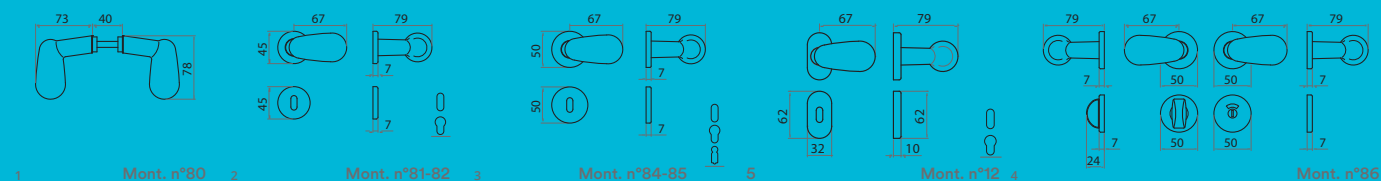

Guarnitura senza molla di ritorno - Handle without spring  
Viti non in dotazione - Screws not provided



Per istruzioni di montaggio  
scansiona QR code,  
seleziona il numero di  
riferimento e segui le  
istruzioni.  
For assembly instructions  
scan the QR code, select the  
relevant assembly number  
and follow the instructions.

# SEVEN

77470

Seven

Aluminum



F1



F4



F9

Handles



F1

	F1	F3	F4	F9	Conf. Pz.
1 Q8 BIL Coppia maniglie con Q8 (Bilancino) Pair handle with 8mm spindle	77470208001	77470208003	77470208004	77470208009	10
2 Q8 R 45 Guarnitura Q8 ros. senza bocc. Lever handle 8mm on rose	77470280001	77470280003	77470280004	77470280009	10
2 Q8 RB 45 Guarnitura Q8 ros./bocc. patent Lever handle 8mm on rose - key hole escutcheon	77470281001	77470281003	77470281004	77470281009	10
2 Q8 RBY 45 Guarnitura Q8 ros./bocc. yale Lever handle 8mm on rose - cyl. hole escutcheon	77470285001	77470285003	77470285004	77470285009	10
3 Q8 R 50 Guarnitura Q8 ros. senza bocc. Lever handle 8mm on rose	77470230001	77470230003	77470230004	77470230009	10
3 Q8 RB 50 Guarnitura Q8 ros./bocc. patent Lever handle 8mm on rose - key hole escutcheon	77470231001	77470231003	77470231004	77470231009	10
3 Q8 RBY 50 Guarnitura Q8 ros./bocc. yale Lever handle 8mm on rose - cyl. hole escutcheon	77470235001	77470235003	77470235004	77470235009	10
4 Q8 RBWC Q6 50 Guarnitura Q8 ros./bocc. Wc Q6 Lever handle 8mm on wc - key hole - escutcheon 6mm	77470238001	77470238003	77470238004	77470238009	10
5 DKx33 8SC BUS. 9,5 SEVEN DKx33 8SC BUS. 9,5 window handle DK x 33mm with pins D.9,5	7747055830158	7747055830358	7747055830458	7747055830958	100
5 DKx35 8SC BUS. 9,5 SEVEN DKx35 8SC BUS. 9,5 window handle DK x 35 mm with pins D.9,5	7747055850158	7747055850358	7747055850458	7747055850958	100
5 DKx40 8SC BUS. 9,5 SEVEN DKx40 8SC BUS. 9,5 window handle DK x 40 mm with pins D.9,5	7747055800158	7747055800358	7747055800458	7747055800958	100
5 DKx45 8SC BUS. 9,5 SEVEN DKx45 8SC BUS. 9,5 window handle DK x 45 mm with pins D.9,5	7747055840158	7747055840358	7747055840458	7747055840958	100

77470

Seven

## PORTA

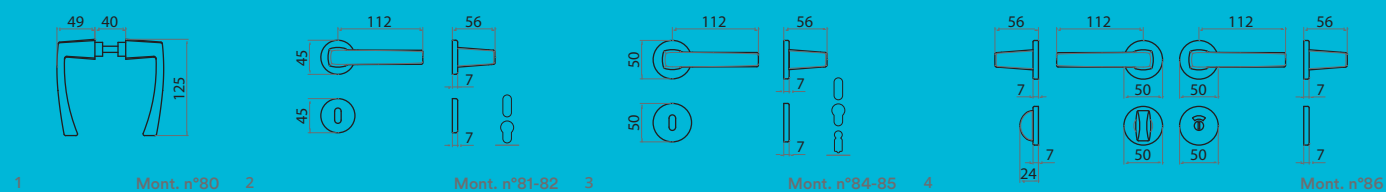

  Guarnitura senza molla di ritorno - Handle without spring  
Viti non in dotazione - Screws not provided

## FINESTRA

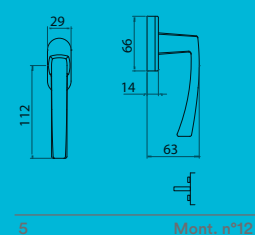

Per istruzioni di montaggio  
scansiona QR code,  
seleziona il numero di  
riferimento e segui le  
istruzioni.  
For assembly instructions  
scan the QR code, select the  
relevant assembly number  
and follow the instructions.

Alluminio

Maniglie



# SEVEN Q

77470

Seven Q

Aluminum



F1



F4



F9



F1

Handles

	F1	F3	F4	F9	Conf. Pz.
1 Q8 BIL Coppia maniglie con Q8 (Bilancino) Pair handle with 8mm spindle	77470208001	77470208003	77470208004	77470208009	10
2 Q8 RQ 50 Guarnitura Q8 ros. QUADRA senza bocc. Lever handle 8mm on square rose	77470210301	77470210303	77470210304	77470210309	10
2 Q8 RBQ 50 Guarnitura Q8 ros./bocc. QUADRA patent Lever handle 8mm on square rose key hole escutcheon	77470211301	77470211303	77470211304	77470211309	10
2 Q8 RBQY 50 Guarnitura Q8 ros./bocc. QUADRA Yale Lever handle 8mm on square rose cyl hole escutcheon	77470215301	77470215303	77470215304	77470215309	10
3 Q8 RBQWC Q6 50 Guarnitura Q8 ros./bocc. QUADRA Wc Q6 Lever handle 8mm on square rose wc hole escutcheon 6mm	77470218001	77470218003	77470218004	77470218009	10
4 DK X 33 C/BUSS D.9,5 SEVEN DKX33 8SC RETT C/BUSS D.9,5 window handle DK x 33mm with pins D.9,5	7747055630158	7747055630358	7747055630458	7747055630958	100
4 DK X 35 C/BUSS D.9,5 SEVEN DKX35 8SC RETT C/BUSS D.9,5 window handle DK x 35mm with pins D.9,5	7747055650158	7747055650358	7747055650458	7747055650958	100
4 DK X 40 C/BUSS D.9,5 SEVEN DKX40 8SC RETT C/BUSS D.9,5 window handle DK x 40mm with pins D.9,5	7747055600158	7747055600358	7747055600458	7747055600958	100
4 DK X 45 C/BUSS D.9,5 SEVEN DKX45 8SC RETT C/BUSS D.9,5 window handle DK x 45mm with pins D.9,5	7747055640158	7747055640358	7747055640458	7747055640958	100

77470

Seven Q

## PORTA

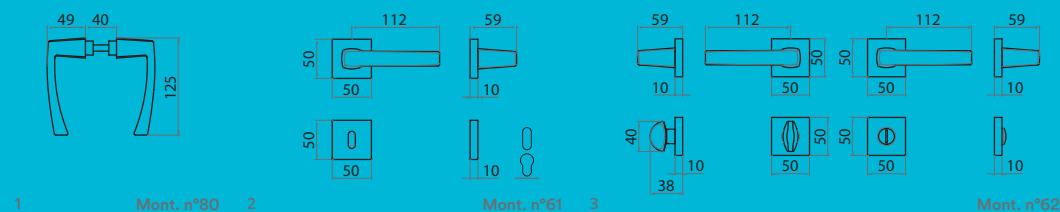

Guarnitura senza molla di ritorno - Handle without spring  
Viti non in dotazione - Screws not provided

## FINESTRA

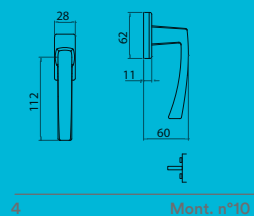

Alluminio



Per istruzioni di montaggio  
scansiona QR code,  
seleziona il numero di  
riferimento e segui le  
istruzioni.  
For assembly instructions  
scan the QR code, select the  
relevant assembly number  
and follow the instructions.

Maniglie

# SHARK

77080

Shark

Aluminum



F1



F4



F9



F1

Handles

	F1	F3	F4	F9	Conf. Pz.
1 Q8 BIL Coppia maniglie con Q8 (Bilancino) Pair handle with 8mm spindle	77080208001	77080208003	77080208004	77080208009	10
2 Q8 R 45 Guarnitura Q8 ros. senza bocc. Lever handle 8mm on rose	77080280001	77080280003	77080280004	77080280009	10
2 Q8 RB 45 Guarnitura Q8 ros./bocc. patent Lever handle 8mm on rose key hole escutcheon	77080281001	77080281003	77080281004	77080281009	10
2 Q8 RBY 45 Guarnitura Q8 ros./bocc. yale Lever handle 8mm on rose - cyl. hole escutcheon	77080285001	77080285003	77080285004	77080285009	10
3 Q8 R 50 Guarnitura Q8 ros. senza bocc. Lever handle 8mm on rose	77080230001	77080230003	77080230004	77080230009	10
3 Q8 RB 50 Guarnitura Q8 ros./bocc. patent Lever handle 8mm on rose key hole escutcheon	77080231001	77080231003	77080231004	77080231009	10
3 Q8 RBY 50 Guarnitura Q8 ros./bocc. yale Lever handle 8mm on rose - cyl. hole escutcheon	77080235001	77080235003	77080235004	77080235009	10
4 Q8 RBWC Q6 50 Guarnitura Q8 ros./bocc. Wc Q6 Lever handle 8mm on wc key hole escutcheon 6mm	77080238001	77080238003	77080238004	77080238009	10
5 DKx33 8SC BUS. 9,5 SHARK DKx33 8SC BUS. 9,5 window handle DK x 33mm with pins D.9,5	7708055830158	7708055830358	7708055830458	7708055830958	100
5 DKx35 8SC BUS. 9,5 SHARK DKx35 8SC BUS. 9,5 window handle DK x 35mm with pins D.9,5	7708055850158	7708055850358	7708055850458	7708055850958	100
5 DKx40 8SC BUS. 9,5 SHARK DKx40 8SC BUS. 9,5 window handle DK x 40mm with pins D.9,5	7708055800158	7708055800358	7708055800458	7708055800958	100
5 DKx45 8SC BUS. 9,5 SHARK DKx45 8SC BUS. 9,5 window handle DK x 45mm with pins D.9,5	7708055840158	7708055840358	7708055840458	7708055840958	100
6 DK X 40-35 GHTECH SHARK GHTEK DK40-35 window handle DK x 40mm GHTECH	77080574001	77080574003	77080574004	77080574009	20
6 DK X 40-35 BUS. 9,5 GHTECH SHARK GHTEK DK40-35 BUS. 9,5 window handle DK x 40 mm with pins D.9,5 GHTECH	77080584001	77080584003	77080584004	77080584009	20

77080

Shark

## PORTA

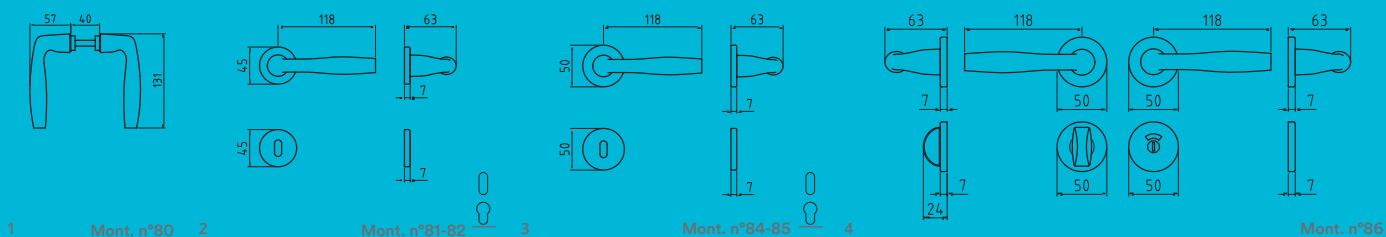

Guarnitura senza molla di ritorno - Handle without spring  
Viti non in dotazione - Screws not provided

## PORTA

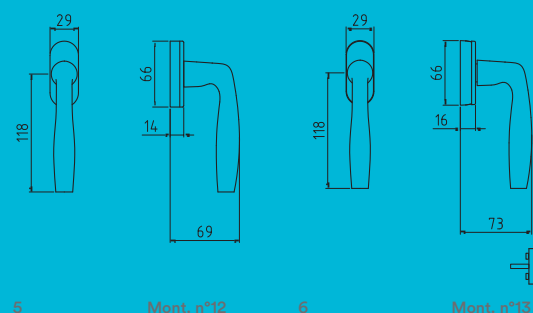

Per istruzioni di montaggio  
scansiona QR code,  
seleziona il numero di  
riferimento e segui le  
istruzioni.  
For assembly instructions  
scan the QR code, select the  
relevant assembly number  
and follow the instructions.

Alluminio

Maniglie

# SUSY - 2040

72040

Susy 2040

Aluminium



F1



F4



F9

	F1	F3	F4	F9	Conf. Pz.
1 Q8 BIL Coppia maniglie con Q8 (Bilancino) Pair handle with 8mm spindle	72040208001	72040208003	72040208004	72040208009	10
2 Q8 P90 Guarnitura Q8 placca patent 90 Lever handle 8mm on key plate 90	72040089001	72040089003	72040089004	72040089009	10
2 Q8 P70 Guarnitura Q8 placca patent 70 Lever handle 8mm on key plate 70	72040087001	72040087003	72040087004	72040087009	10
2 Q8 PY85 Guarnitura Q8 placca yale 85 Lever handle 8mm on cyl. plate 85	72040088501	72040088503	72040088504	72040088509	10
2 Q8 R 45 Guarnitura Q8 ros. senza bocc. Lever handle 8mm on rose	72040280001	72040280003	72040280004	72040280009	10
2 Q8 RB 45 Guarnitura Q8 ros./bocc. patent Lever handle 8mm on rose key hole escutcheon	72040281001	72040281003	72040281004	72040281009	10
2 Q8 RBY 45 Guarnitura Q8 ros./bocc. yale Lever handle 8mm on rose - cyl. hole escutcheon	72040285001	72040285003	72040285004	72040285009	10
2 Q8 R 50 Guarnitura Q8 ros. senza bocc. Lever handle 8mm on rose	72040230001	72040230003	72040230004	72040230009	10
2 Q8 RB 50 Guarnitura Q8 ros./bocc. patent Lever handle 8mm on rose key hole escutcheon	72040231001	72040231003	72040231004	72040231009	10
2 Q8 RBY 50 Guarnitura Q8 ros./bocc. yale Lever handle 8mm on rose - cyl. hole escutcheon	72040235001	72040235003	72040235004	72040235009	10
2 Q8 RBWC Q6 50 Guarnitura Q8 ros./bocc. Wc Q6 Lever handle 8mm on wc key hole escutcheon 6mm	72040238001	72040238003	72040238004	72040238009	10

72040

Susy 2040

## PORTA

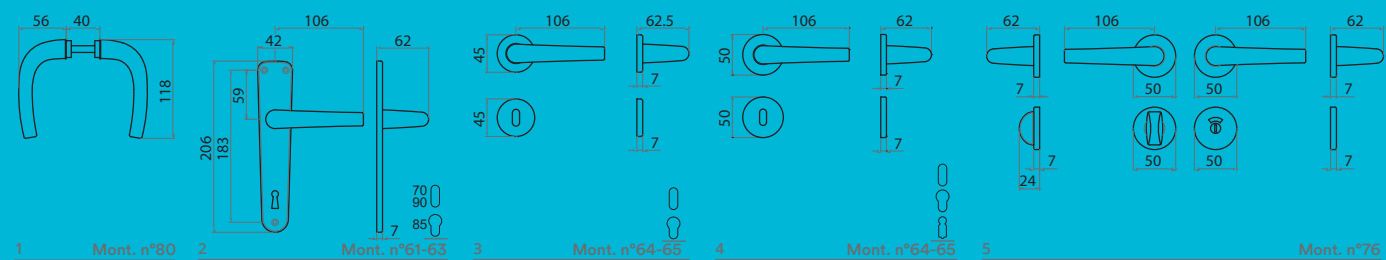

Guarnitura senza molla di ritorno - Handle without spring  
Viti non in dotazione - Screws not provided



Per istruzioni di montaggio  
scansiona QR code,  
seleziona il numero di  
riferimento e segui le  
istruzioni.  
For assembly instructions  
scan the QR code, select the  
relevant assembly number  
and follow the instructions.

Alluminio

Maniglie

# UNIVERSAL

77486

Universal

Aluminum



F1



F4



F9

Handles



F4

	F1	F3	F4	F9	Conf. Pz.
1A Q8 BIL Coppia maniglie con Q8 Pair handle with 8mm spindle	77486208001	77486208003	77486208004	77486208009	10
1B Q8 BIL CB+CA Coppia maniglie collo alto/ collo basso con Q8 special pair of handle for balcony door	77490208001	77490208003	77490208004	77490208009	10
1C Q8 BIL CB Coppia maniglie collo basso con Q8 special pair of handle for balcony door	77488208001	77488208003	77488208004	77488208009	10
2 Q8 P90 Guarnitura Q8 placca patent 90 Lever handle 8mm on key plate 90	77486089001	77486089003	77486089004	77486089009	10
2 Q8 P70 Guarnitura Q8 placca patent 70 Lever handle 8mm on key plate 70	77486087001	77486087003	77486087004	77486087009	10
2 Q8 PY85 Guarnitura Q8 placca yale 85 Lever handle 8mm on cyl. plate 85	77486088501	77486088503	77486088504	77486088509	10
3 Q8 R 45 Guarnitura Q8 ros. senza bocc. Lever handle 8mm on rose	77486280001	77486280003	77486280004	77486280009	10
3 Q8 RB 45 Guarnitura Q8 ros./bocc. patent Lever handle 8mm on rose key hole escutcheon	77486281001	77486281003	77486281004	77486281009	10
3 Q8 RBY 45 Guarnitura Q8 ros./bocc. yale Lever handle 8mm on rose - cyl. hole escutcheon	77486285001	77486285003	77486285004	77486285009	10
4 Q8 R 50 Guarnitura Q8 ros. senza bocc. Lever handle 8mm on rose	77486230001	77486230003	77486230004	77486230009	10
4 Q8 RB 50 Guarnitura Q8 ros./bocc. patent Lever handle 8mm on rose key hole escutcheon	77486231001	77486231003	77486231004	77486231009	10
4 Q8 RBY 50 Guarnitura Q8 ros./bocc. yale Lever handle 8mm on rose - cyl. hole escutcheon	77486235001	77486235003	77486235004	77486235009	10
5 Q8 RBWC Q6 50 Guarnitura Q8 ros./bocc. Wc Q6 Lever handle 8mm on wc key hole escutcheon 6mm	77486238001	77486238003	77486238004	77486238009	10
6 DKx33 8SC BUS. 9,5 UNIVERSAL DKx33 8SC BUS. 9,5 window handle DK x 33mm with pins D.9,5	7748655830158	7748655830358	7748655830458	7748655830958	100
6 DKx35 8SC BUS. 9,5 UNIVERSAL DKx35 8SC BUS. 9,5 window handle DK x 35mm with pins D.9,5	7748655850158	7748655850358	7748655850458	7748655850958	100
6 DKx40 8SC BUS. 9,5 UNIVERSAL DKx40 8SC BUS. 9,5 window handle DK x 40mm with pins D.9,5	7748655800158	7748655800358	7748655800458	7748655800958	100
6 DKx45 8SC BUS. 9,5 UNIVERSAL DKx45 8SC BUS. 9,5 window handle DK x 45mm with pins D.9,5	7748655840158	7748655840358	7748655840458	7748655840958	100

PORTA

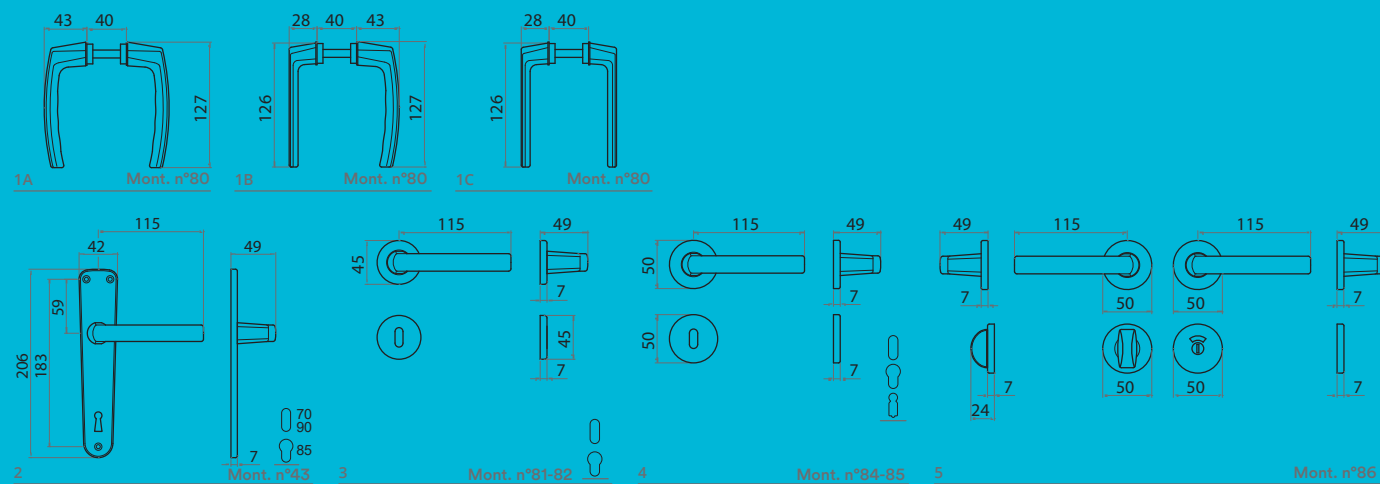

Guarnitura senza molla di ritorno - Handle without spring  
Viti non in dotazione - Screws not provided

FINESTRA

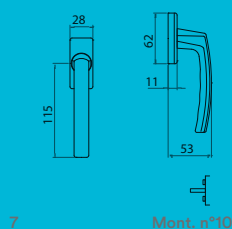

Per istruzioni di montaggio scansiona QR code, seleziona il numero di riferimento e segui le istruzioni.  
For assembly instructions scan the QR code, select the relevant assembly number and follow the instructions.



# UNO

77796

Uno

Aluminum



F1



F4



F9

	F1	F3	F4	F9	Conf. Pz.
1 Q8 BIL Coppia maniglie con Q8 (Bilancino) Pair handle with 8mm spindle	77796208001	77796208003	77796208004	77796208009	10
2 Q8 R 45 Guarnitura Q8 ros. senza bocc. Lever handle 8mm on rose	77796280001	77796280003	77796280004	77796280009	10
2 Q8 RB 45 Guarnitura Q8 ros./bocc. patent Lever handle 8mm on rose key hole escutcheon	77796281001	77796281003	77796281004	77796281009	10
2 Q8 RBY 45 Guarnitura Q8 ros./bocc. yale Lever handle 8mm on rose - cyl. hole escutcheon	77796285001	77796285003	77796285004	77796285009	10
3 Q8 R 50 Guarnitura Q8 ros. senza bocc. Lever handle 8mm on rose	77796230001	77796230003	77796230004	77796230009	10
3 Q8 RB 50 Guarnitura Q8 ros./bocc. patent Lever handle 8mm on rose key hole escutcheon	77796231001	77796231003	77796231004	77796231009	10
3 Q8 RBY 50 Guarnitura Q8 ros./bocc. yale Lever handle 8mm on rose - cyl. hole escutcheon	77796235001	77796235003	77796235004	77796235009	10
4 Q8 RBWC Q6 50 Guarnitura Q8 ros./bocc. Wc Q6 Lever handle 8mm on wc key hole escutcheon 6mm	77796238001	77796238003	77796238004	77796238009	10

77796

Uno

## PORTA

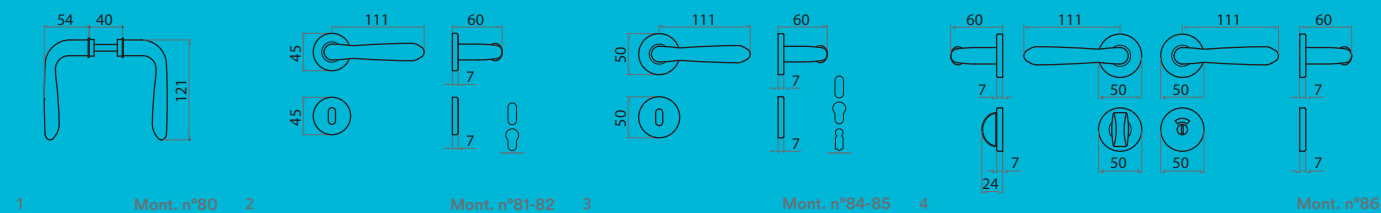

1 Mont. n°80 2 Mont. n°81-82 3 Mont. n°84-85 4 Mont. n°86



Guarnitura senza molla di ritorno - Handle without spring  
Viti non in dotazione - Screws not provided

Alluminio



Per istruzioni di montaggio  
scansiona QR code,  
seleziona il numero di  
riferimento e segui le  
istruzioni.  
For assembly instructions  
scan the QR code, select the  
relevant assembly number  
and follow the instructions.

Maniglie

# 2071

72071

2071

Aluminum



	F1	F3	F4	F9	Conf. Pz.
Q8 BIL	72071208001	72071208003	72071208004	72071208009	10
2071 Q8 BIL					
Pair handle with 8mm spindle					

72071

2071

PORTA



Alluminio

Maniglie

# 2006 CUORE

72006

2006 Cuore

Aluminum



	F1	F3	F4	Conf. Pz.
Q8 BIL	72006208001	72006208003	72006208004	
2006 Q8 BIL				10
Pair handle with 8mm spindle				

72006

2006 Cuore

## PORTA

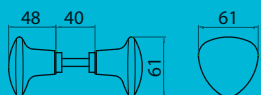

Alluminio

Maniglie

# 2

**Serramenti**

**Windows**

228 Indice alfabetico serramenti / Alphabetical index windows

230 Alluminio galattico / Galactic Aluminum  
232 Zama / Zamak  
268 Ottone / Brass  
286 Alluminio / Aluminum  
308 Alluminio galattico / Galactic Aluminum  
309 Zama / Zamak  
310 Ottone / Brass  
312 Alluminio / Aluminum



# Indice alfabetico serramenti

141	AL. GALATTICO	231	SEVEN	ALLUMINIO	298
4038	ALLUMINIO	302	SEVEN Q	ZAMA	257
7900	AL. GALATTICO	230	SEVEN Q	ALLUMINIO	299
7900	ALLUMINIO	286	SHARK	ALLUMINIO	300
7900 ALZANTE	AL. GALATTICO	308	SHARK ALZANTE	OTTONE	310
7900 ALZANTE	ALLUMINIO	313	SHARK	ZAMA	258
2005 ITACA	ALLUMINIO	295	SWING	ZAMA	259
2010 - 3013	ALLUMINIO	304	TOY	ZAMA	260
6008 - 6010	ALLUMINIO	305	TOY Q	ZAMA	261
ARCHIMEDE	ALLUMINIO	286	UNIVERSAL	ALLUMINIO	301
(BALCONY)	ALLUMINIO	306	UNIVERSALE	ALLUMINIO	303
(BALCONY)	ALLUMINIO	307	UNO	OTTONE	284
BAROCCO	OTTONE	268	UNO Z	ZAMA	262
BRIXIA	ALLUMINIO	288	VICTORIA	ZAMA	263
BRIXIA 2	ALLUMINIO	289	WING	ZAMA	264
CARLO	ALLUMINIO	290	YORK	ZAMA	265
CARTER	ZAMA	232	YORK ALZANTE	ZAMA	309
CARTESIO	ZAMA	233	YORK BERRY	ZAMA	266
CARTESIO B/W	ZAMA	234	YORK Q	ZAMA	267
CARTESIO Q	ZAMA	235			
CARTESIO Q B/W	ZAMA	236			
CLIP	ZAMA	237			
DELTA	ALLUMINIO	291			
EASY	OTTONE	269			
EASY Q	OTTONE	270			
ELITE	OTTONE	271			
EUROPA ALZANTE	ALLUMINIO	312			
FARFALLA	ZAMA	238			
FERGIE	ZAMA	239			
FLY 24	ALLUMINIO	292			
FLY SCREEN	ALLUMINIO	293			
GABRY	ALLUMINIO	294			
GALILEO	ZAMA	240			
GALILEO Q	ZAMA	241			
GINEVRA	OTTONE	272			
GIOCHI PER CR.	FERRO	285			
GM05	ZAMA	242			
GM07	ZAMA	243			
GM08	ZAMA	244			
GM10	ZAMA	245			
GM11	ZAMA	246			
GOLF	OTTONE	273			
IDEA	ZAMA	247			
IDEA Q	ZAMA	248			
ITACA ALZANTE	ALLUMINIO	314			
KEY	ALLUMINIO	296			
LADY	OTTONE	274			
LEAF	ZAMA	249			
LITZ	ZAMA	250			
MILENA	OTTONE	275			
MILENA ALZANTE	OTTONE	311			
MILENA Z	ZAMA	251			
NION	ZAMA	252			
NION Q	ZAMA	253			
NOVECENTO	OTTONE	276			
PIGNA	OTTONE	277			
R5200	OTTONE	278			
R716	OTTONE	279			
R771	OTTONE	280			
R775	OTTONE	281			
R901	OTTONE	282			
R938	ZAMA	254			
R988	OTTONE	283			
RIALTO	ZAMA	255			
ROOF	ALLUMINIO	297			
SEVEN	ZAMA	256			

# Alphabetical index windows

141	GALACTICAL AL.	231	SEVEN	ALUMINUM	298
4038	ALUMINUM	302	SEVEN Q	ZAMAK	257
7900	GALACTICAL AL.	230	SEVEN Q	ALUMINUM	299
7900	ALUMINUM	286	SHARK	ALUMINUM	300
7900 PULL H.	GALACTICAL AL.	308	SHARK PULL H.	BRASS	310
7900 PULL H.	ALUMINUM	313	SHARK	ZAMAK	258
2005 ITACA	ALUMINUM	295	SWING	ZAMAK	259
2010 - 3013	ALUMINUM	304	TOY	ZAMAK	260
6008 - 6010	ALUMINUM	305	TOY Q	ZAMAK	261
ARCHIMEDE	ALUMINUM	287	UNIVERSAL	ALUMINUM	301
(BALCONY)	ALUMINUM	306	UNIVERSALE	ALUMINUM	303
(BALCONY)	ALUMINUM	307	UNO	BRASS	284
BAROCCO	BRASS	268	UNO Z	ZAMAK	262
BRIXIA	ALUMINUM	288	VICTORIA	ZAMAK	263
BRIXIA 2	ALUMINUM	289	WING	ZAMAK	264
CARLO	ALUMINUM	290	YORK	ZAMAK	265
CARTER	ZAMAK	232	YORK PULL H.	ZAMAK	309
CARTESIO	ZAMAK	233	YORK BERRY	ZAMAK	266
CARTESIO B/W	ZAMAK	234	YORK Q	ZAMAK	267
CARTESIO Q	ZAMAK	235			
CARTESIO Q B/W	ZAMAK	236			
CLIP	ZAMAK	237			
DELTA	ALUMINUM	291			
EASY	BRASS	269			
EASY Q	BRASS	270			
ELITE	BRASS	271			
EUROPA PULL H.	ALUMINUM	312			
FARFALLA	ZAMAK	238			
FERGIE	ZAMAK	239			
FLY 24	ALUMINUM	292			
FLY SCREEN	ALUMINUM	293			
GABRY	ALUMINUM	294			
GALILEO	ZAMAK	240			
GALILEO Q	ZAMAK	241			
GINEVRA	BRASS	272			
GIOCHI PER CR.	IRON	285			
GM05	ZAMAK	242			
GM07	ZAMAK	243			
GM08	ZAMAK	244			
GM10	ZAMAK	245			
GM11	ZAMAK	246			
GOLF	BRASS	273			
IDEA	ZAMAK	247			
IDEA Q	ZAMAK	248			
ITACA PULL H.	ALUMINUM	314			
KEY	ALUMINUM	296			
LADY	BRASS	274			
LEAF	ZAMAK	249			
LITZ	ZAMAK	250			
MILENA	BRASS	275			
MILENA PULL H.	BRASS	311			
MILENA Z	ZAMAK	251			
NION	ZAMAK	252			
NION Q	ZAMAK	253			
NOVECENTO	BRASS	276			
PIGNA	BRASS	277			
R5200	BRASS	278			
R716	BRASS	279			
R771	BRASS	280			
R775	BRASS	281			
R901	BRASS	282			
R938	ZAMAK	254			
R988	BRASS	283			
RIALTO	ZAMAK	255			
ROOF	ALUMINUM	297			
SEVEN	ZAMAK	256			

# 7900

ALLUMINIO GALATTICO

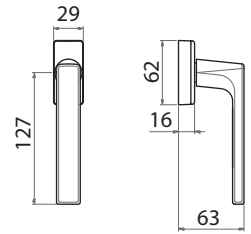

		MERCURY	URANUS	JUPITER	SPACE	Conf. Pz.
1	DK40 BUS, 9,5 7900 GHTEK DK40 BUS. 9,5 window handle DK x 40mm with pins D.9,5	77900583033	77900583034	77900583041	77900583076	20
2	DK45 BUS, 9,5 c/viti 7900 GHTEK DK45 BUS. 9,5 c/viti window handle DK x 45mm with pins D.9,5 and screws	7790058333391	7790058333491	7790058334191	7790058337691	20

⚡ Servizio G48: Articolo a magazzino e disponibile entro 48 dall'elaborazione dell'ordine. In base a disponibilita' e condizioni di vendita.  
G48 service: Item in stock and available within 48 hours of order processing. Based on availability and sales conditions.



Per istruzioni di montaggio  
scansiona QR code,  
seleziona il numero di  
riferimento e segui le  
istruzioni.  
For assembly instructions  
scan the QR code, select the  
relevant assembly number  
and follow the instructions.

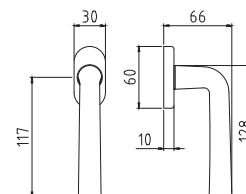

Mont. n°4

		MERCURY	URANUS	JUPITER	SPACE	Conf. Pz.
1	DK x 40 C/BUSS D.9,5 141 DKx40 C/BUSS D.9,5 window handle DK x 40 mm with pins D.9,5	7014155803395	7014155803495	7014155804195	7014155807695	2
2	DK x 45 C/BUSS D.9,5 C/viti 141 DKx45 C/BUSS D.9,5 C/viti window handle DK x 45 mm with pins D.9,5 with screws	7014155843395	7014155843495	7014155844195	7014155847695	2



Per istruzioni di montaggio scansiona QR code, seleziona il numero di riferimento e segui le istruzioni.  
For assembly instructions scan the QR code, select the relevant assembly number and follow the instructions.

# CARTER

DESIGN MESSINEO E SETTIMELLI

ZAMA

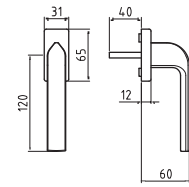

3 Gioco in ferro



Mont. n°6

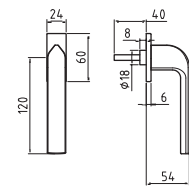

4 Mont. n°7



Mont. n°7

	ZCL	ZCS	ZNO	Conf. Pz.
3 DK X 40 C/BUSS Martellina DK Q7 x 40 con bussole D. 9,5 gioco in ferro window handle DK x 40mm with pins D.9,5 iron mechanism	66510553807	66510553813	66510553816	2
4 DK X 40 ribassato Martellina DK Q7 x 40 ribassato window handle DK x 40 mm thin mechanism	66510594007	66510594013	66510594016	2



Per istruzioni di montaggio  
scansiona QR code,  
seleziona il numero di  
riferimento e segui le  
istruzioni.  
For assembly instructions  
scan the QR code, select the  
relevant assembly number  
and follow the instructions.

# CARTESIO

DESIGN FABRIZIO BIANCHETTI

ZAMA

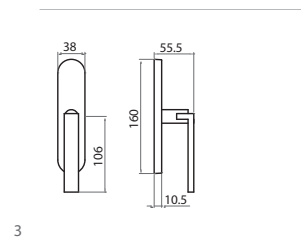

3

Mont. n°140-141

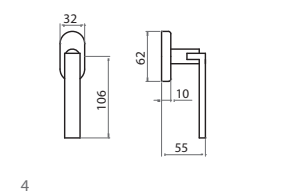

4



Mont. n°4

		ZCL-F1-SAT	Conf. Pz.
3	<b>EZ IM</b> Cremonese gioco EZ imp. maniglia Mechanism for window handle spindle 7 mm	55012456054	2
3	<b>EZQ7 IM</b> Cremonese gioco EZ + Q7 imp. maniglia Mechanism for window handle spindle 7 mm	55012457054	2
3	<b>MART IM</b> Martellina Q7 imp. Maniglia lever window handle	55012550054	2
4	<b>DK X 40</b> Martellina DK Q7 x 40 window handle DK x 40 mm	55012557054	2
4	<b>DK X 40 C/BUSS</b> Martellina DK Q7 x 40 con bussole D. 9,5 window handle DK x 40mm with pins D.9,5	55012558054	2



Per istruzioni di montaggio  
scansiona QR code,  
seleziona il numero di  
riferimento e segui le  
istruzioni.  
For assembly instructions  
scan the QR code, select the  
relevant assembly number  
and follow the instructions.

# CARTESIO B/W

DESIGN FABRIZIO BIANCHETTI

ZAMA

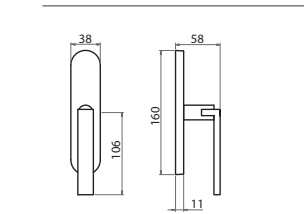

3

Mont. n°140-141

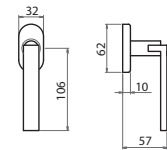

4



Mont. n°4

	ZCL-WHITE	ZCL-BLACK	Conf. Pz.
3 EZ IM Cremonese gioco EZ imp. maniglia Mechanism for window handle spindle 7 mm	55012456077	55012456086	2
3 EZQ7 IM Cremonese gioco EZ + Q7 imp. maniglia Mechanism for window handle spindle 7 mm	55012457077	55012457086	2
3 MART IM Martellina Q7 imp. Maniglia lever window handle	55012550077	55012550086	2
4 DK X 40 Martellina DK Q7 x 40 window handle DK x 40 mm	55012557077	55012557086	2
4 DK X 40 C/BUSS Martellina DK Q7 x 40 con bussole D. 9,5 window handle DK x 40mm with pins D.9,5	55012558077	55012558086	2



Per istruzioni di montaggio  
scansiona QR code,  
seleziona il numero di  
riferimento e segui le  
istruzioni.

For assembly instructions  
scan the QR code, select the  
relevant assembly number  
and follow the instructions.

# CARTESIO Q

DESIGN FABRIZIO BIANCHETTI

ZAMA

235

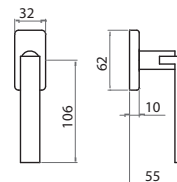

3 DK-1P



Mont. n°6

		ZCL-F1-SAT	Conf. Pz.
3	DK X 40 Martellina DK Q7 x 40 window handle DK x 40 mm	44994557054	2
3	DK X 40 C/BUSS Martellina DK Q7 x 40 con bussole D. 9,5 window handle DK x 40mm with pins D.9,5	44994558054	2



Per istruzioni di montaggio  
scansiona QR code,  
seleziona il numero di  
riferimento e segui le  
istruzioni.  
For assembly instructions  
scan the QR code, select the  
relevant assembly number  
and follow the instructions.



# CARTESIO Q B/W

DESIGN FABRIZIO BIANCHETTI

ZAMA

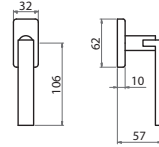

3



Mont. n°6

	ZCL-WHITE	ZCL-BLACK	Conf. Pz.
4 DK X 40 Martellina DK Q7 x 40 window handle DK x 40 mm	44994557077	44994557086	2
4 DK X 40 C/BUSS Martellina DK Q7 x 40 con bussole D. 9,5 window handle DK x 40mm with pins D.9,5	44994558077	44994558086	2



Per istruzioni di montaggio  
scansiona QR code,  
seleziona il numero di  
riferimento e segui le  
istruzioni.  
For assembly instructions  
scan the QR code, select the  
relevant assembly number  
and follow the instructions.

# CLIP

DESIGN XXY DESIGN

ZAMA

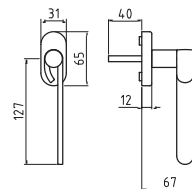

3 Gioco in ferro



Mont. n°2

3	DK X 40 C/BUSS	ZNO-TITANIUM	ZCS-BLACK	ZCL-ZCS	Conf. Pz.
	Martellina DK Q7 x 40 con bussole D. 9,5 gioco in ferro window handle DK x 40mm with pins D.9,5 iron mechanism	66530549518	66530549521	66530549559	2



Per istruzioni di montaggio  
scansiona QR code,  
seleziona il numero di  
riferimento e segui le  
istruzioni.  
For assembly instructions  
scan the QR code, select the  
relevant assembly number  
and follow the instructions.

# FARFALLA

DESIGN FRANCESCO LUCCHESI

ZAMA

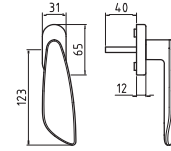

3

Gioco in ferro



Mont. n°1

	ZCL	ZCS	ZNO	TITANIUM	Conf. Pz.
3 DK X 40 C/BUSS Martellina DK Q7 x 40 con bussole D. 9,5 gioco in ferro window handle DK x 40mm with pins D.9,5 iron mechanism	66525549507	66525549513	66525549516	66525549554	2



Per istruzioni di montaggio  
scansiona QR code,  
seleziona il numero di  
riferimento e segui le  
istruzioni.  
For assembly instructions  
scan the QR code, select the  
relevant assembly number  
and follow the instructions.

# FERGIE

DESIGN XXY DESIGN

ZAMA

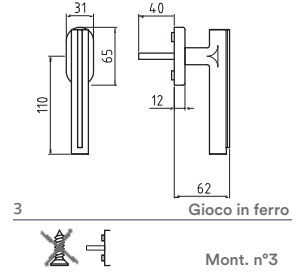

	ZCL	ZCS	ZNO	TITANIUM	Conf. Pz.
3 DK X 40 C/BUSS Martellina DK Q7 x 40 con bussole D. 9,5 gioco in ferro window handle DK x 40mm with pins D.9,5 iron mechanism	66535549507	66535549513	66535549516	66535549554	2



Per istruzioni di montaggio scansiona QR code, seleziona il numero di riferimento e segui le istruzioni.  
For assembly instructions scan the QR code, select the relevant assembly number and follow the instructions.

# GALILEO

DESIGN FABRIZIO BIANCHETTI

ZAMA

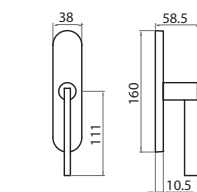

3

Mont. n°140-141

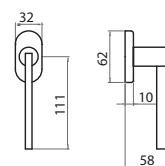

4 DK-1P



Mont. n°4

		ZCL-F1-SAT	Conf. Pz.
3	<b>EZ IM</b> Cremonese gioco EZ imp. maniglia Mechanism for window handle spindle 7 mm	55112456054	2
3	<b>EZQ7 IM</b> Cremonese gioco EZ + Q7 imp. maniglia Mechanism for window handle spindle 7 mm	55112457054	2
3	<b>MART IM</b> Martellina Q7 imp. Maniglia lever window handle	55112550054	2
4	<b>DK X 40</b> Martellina DK Q7 x 40 window handle DK x 40 mm	55112557054	2
4	<b>DK X 40 C/BUSS</b> Martellina DK Q7 x 40 con bussole D. 9,5 window handle DK x 40mm with pins D.9,5	55112558054	2



Per istruzioni di montaggio  
scansiona QR code,  
seleziona il numero di  
riferimento e segui le  
istruzioni.

For assembly instructions  
scan the QR code, select the  
relevant assembly number  
and follow the instructions.

# GALILEO Q

DESIGN FABRIZIO BIANCHETTI

ZAMA

241

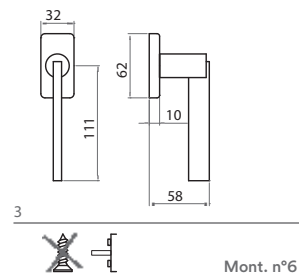

3	DK X 40 Martellina DK Q7 x 40 window handle DK x 40 mm	ZCL-F1-SAT 44996557054	Conf. Pz. 2
3	DK X 40 C/BUSS Martellina DK Q7 x 40 con bussole D. 9,5 window handle DK x 40mm with pins D.9,5	44996558054	2



Per istruzioni di montaggio  
scansiona QR code,  
seleziona il numero di  
riferimento e segui le  
istruzioni.  
For assembly instructions  
scan the QR code, select the  
relevant assembly number  
and follow the instructions.

# GM05

ZAMA

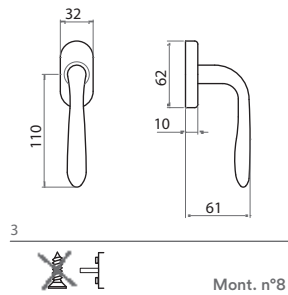

		ZGV	ZCL	GCTOL	ZCS	Conf. Pz.
3	DK X 40 Martellina DK Q7 x 40 window handle DK x 40 mm	6GM58557004	6GM58557007	6GM58557012	6GM58557013	2
3	DK X 40 C/BUSS. Martellina DK Q7 x 40 con bussole D. 9,5 window handle DK x 40mm with pins D.9,5	6GM58558004	6GM58558007	6GM58558012	6GM58558013	2



Per istruzioni di montaggio  
scansiona QR code,  
seleziona il numero di  
riferimento e segui le  
istruzioni.  
For assembly instructions  
scan the QR code, select the  
relevant assembly number  
and follow the instructions.

# GM07

ZAMA

243

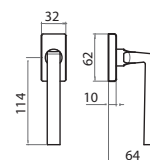

3      Gioco in ferro



Mont. n°6

	ZCL	ZCS	Conf. Pz.
3 DK x 40 Martellina DK Q7 x 40 window handle DK x 40 mm	6GM07555007	6GM07555013	2
3 DK X 40 C/BUS Martellina DK Q7 x 40 con bussole D. 9,5 window handle DK x 40mm with pins D.9,5	6GM07556007	6GM07556013	2



Per istruzioni di montaggio  
scansiona QR code,  
seleziona il numero di  
riferimento e segui le  
istruzioni.  
For assembly instructions  
scan the QR code, select the  
relevant assembly number  
and follow the instructions.



# GM08

ZAMA

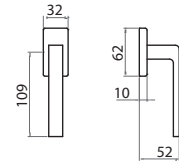

3



Mont. n°6

		ZCL	ZCS	Conf. Pz.
3	DK X 40 Martellina DK Q7 x 40 window handle DK x 40 mm	6GM08555007	6GM08555013	2
3	DK X 40 C/BUSS. Martellina DK Q7 x 40 con bussole D. 9,5 window handle DK x 40mm with pins D.9,5	6GM08556007	6GM08556013	2



Per istruzioni di montaggio  
scansiona QR code,  
seleziona il numero di  
riferimento e segui le  
istruzioni.  
For assembly instructions  
scan the QR code, select the  
relevant assembly number  
and follow the instructions.

# GM10

ZAMA

245

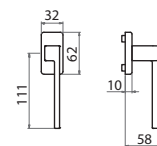

3



Mont. n°6

	ZCL	ZCS	ZNO	Conf. Pz.
3 DK X 40 Martellina DK Q7 x 40 window handle DK x 40 mm	6GM10555007	6GM10555013	6GM10555016	2
3 DK X 40 C/BUSS. Martellina DK Q7 x 40 con bussole D. 9,5 window handle DK x 40mm with pins D.9,5	6GM10556007	6GM10556013	6GM10556016	2



Per istruzioni di montaggio  
scansiona QR code,  
seleziona il numero di  
riferimento e segui le  
istruzioni.  
For assembly instructions  
scan the QR code, select the  
relevant assembly number  
and follow the instructions.

# GM11

ZAMA

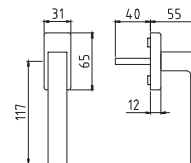

3



Mont. n°6

	ZCL	ZCS	Conf. Pz.
3 DK X 40 C/BUSS. Martellina DK Q7 x 40 con bussole D. 9,5 window handle DK x 40mm with pins D.9,5	6GM11553807	6GM11553813	2



Per istruzioni di montaggio  
scansiona QR code,  
seleziona il numero di  
riferimento e segui le  
istruzioni.  
For assembly instructions  
scan the QR code, select the  
relevant assembly number  
and follow the instructions.

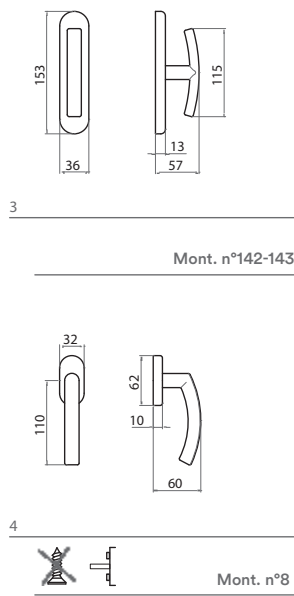

	ZCL	ZCS	ZNS	Conf. Pz.
3 EZ Cremonese gioco EZ Mechanism for window handle spindle 7 mm	66094406007	66094406013	66094406027	2
3 EZQ7 Cremonese gioco EZ + Q7 Mechanism for window handle spindle 7 mm	66094407007	66094407013	66094407027	2
3 MART Martellina Q7 window handle	66094500007	66094500013	66094500027	2
4 DK x 40-35 Martellina DK Q7 x 40-35 window handle DK x 40-35mm	66092577007	66092577013	66092577027	2
4 DK x 40-35 C/BUSS Martellina DK Q7 x 40-35 con bussole window handle DK x 40-35 mm with pins D.9,5	66092578007	66092578013	66092578027	2



Per istruzioni di montaggio scansiona QR code, seleziona il numero di riferimento e segui le istruzioni.  
For assembly instructions scan the QR code, select the relevant assembly number and follow the instructions.

# IDEA Q

ZAMA

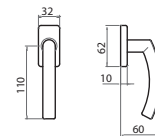

3



Mont. n°9

	ZCL	ZCS	ZNS	Conf. Pz.
3 DK x 40-35 Martellina DK Q7 x 40-35 window handle DK x 40-35mm	66080577007	66080577013	66080577027	2
3 DK x 40-35 C/BUSS Martellina DK Q7 x 40-35 con bussole window handle DK x 40-35 mm with pins D.9,5	66080578007	66080578013	66080578027	2



Per istruzioni di montaggio  
scansiona QR code,  
seleziona il numero di  
riferimento e segui le  
istruzioni.  
For assembly instructions  
scan the QR code, select the  
relevant assembly number  
and follow the instructions.

# LEAF

DESIGN MESSINEO E SETTIMELLI

ZAMA

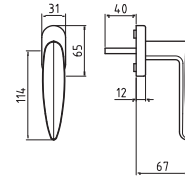

3 DK-1F Gioco in ferro



Mont. n°4

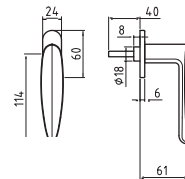

4 DK-1R



Mont. n°5

	ZCL	ZCS	ZNO	Conf. Pz.
4 DK X 40 C/BUSS Martellina DK Q7 x 40 con bussole D. 9,5 gioco in ferro window handle DK x 40mm with pins D.9,5 iron mechanism	66505549507	66505549513	66505549516	2
5 DK X 40 ribassato Martellina DK Q7 x 40 ribassato window handle DK x 40 mm thin mechanism	66505596007	66505596013	66505596016	2



Per istruzioni di montaggio scansiona QR code, seleziona il numero di riferimento e segui le istruzioni.  
For assembly instructions scan the QR code, select the relevant assembly number and follow the instructions.

# LITZ

DESIGN MESSINEO E SETTIMELLI

ZAMA

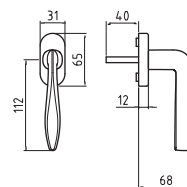

3 | Gioco in ferro



Mont. n°4

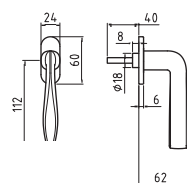

4 |



Mont. n°5

	ZCL	ZCS	ZNO	Conf. Pz.
3 DK X 40 C/BUSS Martellina DK Q7 x 40 con bussole D. 9,5 gioco in ferro window handle DK x 40mm with pins D.9,5 iron mechanism	66500549507	66500549513	66500549516	2
4 DK X 40 ribassato Martellina DK Q7 x 40 ribassato window handle DK x 40 mm thin mechanism	66500596007	66500596013	66500596016	2



Per istruzioni di montaggio  
scansiona QR code,  
seleziona il numero di  
riferimento e segui le  
istruzioni.  
For assembly instructions  
scan the QR code, select the  
relevant assembly number  
and follow the instructions.

# MILENA Z

ZAMA

251

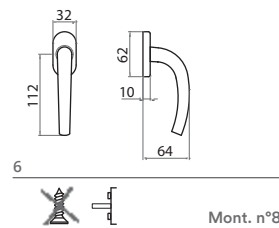

	ZCL	GCTOL	ZCS	Conf. Pz.
6 DK X 40 Martellina DK Q7 x 40 window handle DK x 40 mm	66744557007	66744557012	66744557013	2
6 DK X 40 C/BUSS. Martellina DK Q7 x 40 con bussole D. 9,5 window handle DK x 40mm with pins D.9,5	66744558007	66744558012	66744558013	2



Per istruzioni di montaggio  
scansiona QR code,  
seleziona il numero di  
riferimento e segui le  
istruzioni.  
For assembly instructions  
scan the QR code, select the  
relevant assembly number  
and follow the instructions.



# NION

ZAMA

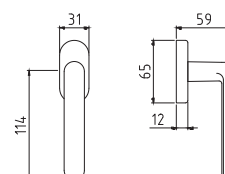
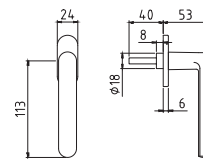

	ZCS	ZNO	Z-BGO	Z-OSO	Conf. Pz.
2 DK X 40 ribassato Martellina DK Q7 x 40 ribassato window handle DK x 40 mm thin mechanism	R0754596013	R0754596016	R0754596064	R0754596066	2
3 DK X 40 C/BUSS Martellina DK Q7 x 40 con bussole D. 9,5 gioco in ferro window handle DK x 40mm with pins D.9,5 iron mechanism	R075400048213	R075400048216	R075400048264	R075400048266	2



Per istruzioni di montaggio  
scansiona QR code,  
seleziona il numero di  
riferimento e segui le  
istruzioni.  
For assembly instructions  
scan the QR code, select the  
relevant assembly number  
and follow the instructions.



## FINESTRA

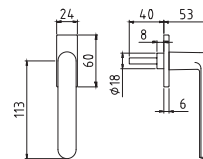

2



Mont. n°7

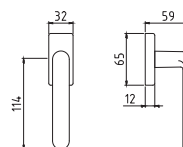

3



Mont. n°6

	ZCS	ZNO	Z-BGO	Z-OSO	Conf. Pz.
2 DK X 40 ribassato Martellina DK Q7 x 40 ribassato window handle DK x 40 mm thin mechanism	R0754594013	R0754594016	R0754594064	R0754594066	2
3 DK X 40 C/BUSS Martellina DK Q7 x 40 con bussole D. 9,5 gioco in ferro window handle DK x 40mm with pins D.9,5 iron mechanism	R075400C48213	R075400C48216	R075400C48264	R075400C48266	2



Per istruzioni di montaggio scansiona QR code, seleziona il numero di riferimento e segui le istruzioni.  
For assembly instructions scan the QR code, select the relevant assembly number and follow the instructions.

# R938

ZAMA



## FINESTRA

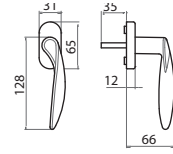

2 DK 45 \_\_\_\_\_ Gioco in ferro



Mont. n°4

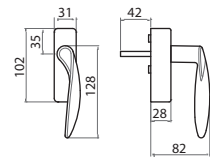

3 RG \_\_\_\_\_



Mont. n°11

	ZCL	GCTOL	ZCS	ZNS	Conf. Pz.
4 DK x 35 C/BUSS. Martellina DK Q7x35 c/bussole D.9,5 mm viti metriche window handle DK x 35 mm with pins D.9,5 metric screws	R09380004800790	R09380004801290	R09380004801390	R09380004802790	1
11 DK x 42 C/CHIAVE C/BUSS. Martellina con chiave DK Q7x42 c/bussole D.9,5 mm viti metriche window handle DK x 42mm with key / pins D.9,5 with screws	R093800A4840790	R093800A4841290	R093800A4841390	R093800A4842790	1



Per istruzioni di montaggio  
scansiona QR code,  
seleziona il numero di  
riferimento e segui le  
istruzioni.  
For assembly instructions  
scan the QR code, select the  
relevant assembly number  
and follow the instructions.



## FINESTRA

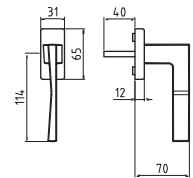

3 Gioco in ferro



Mont. n°6

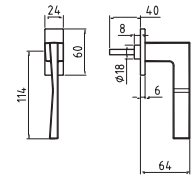

4 Mont. n°7

	ZCL	ZCS	ZNO	Conf. Pz.
6 DK X 40 C/BUSS Martellina DK Q7 x 40 con bussole D. 9,5 gioco in ferro window handle DK x 40mm with pins D.9,5 iron mechanism	66515553807	66515553813	66515553816	2
7 DK X 40 ribassato Martellina DK Q7 x 40 ribassato window handle DK x 40 mm thin mechanism	66515594007	66515594013	66515594016	2



Per istruzioni di montaggio  
scansiona QR code,  
seleziona il numero di  
riferimento e segui le  
istruzioni.  
For assembly instructions  
scan the QR code, select the  
relevant assembly number  
and follow the instructions.

# SEVEN

ZAMA

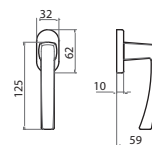

3



Mont. n°4

	ZCL	GCTOL	ZCS	ZNS	Conf. Pz.
3 DK x 40 Martellina DK Q7x40 window handle DK x 40 mm	66470557007	66470557012	66470557013	66470557027	2
3 DK X 40 C/BUSS. Martellina DK Q7 x 40 con bussole D.9,5 mm window handle DK x 40mm with pins D.9,5	66470558007	66470558012	66470558013	66470558027	2



Per istruzioni di montaggio  
scansiona QR code,  
seleziona il numero di  
riferimento e segui le  
istruzioni.  
For assembly instructions  
scan the QR code, select the  
relevant assembly number  
and follow the instructions.

# SEVEN Q

ZAMA

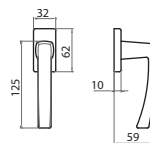

3



Mont. n°6

	ZCL	GCTOL	ZCS	ZNS	Conf. Pz.
3 DK x 40 Martellina DK Q7 x 40 window handle DK x 40 mm	66470555007	66470555012	66470555013	66470555027	2
3 DK X 40 C/BUSS. Martellina DK Q7 x 40 con bussole D.9,5 mm window handle DK x 40mm with pins D.9,5	66470556007	66470556012	66470556013	66470556027	2



Per istruzioni di montaggio scansiona QR code, seleziona il numero di riferimento e segui le istruzioni.  
For assembly instructions scan the QR code, select the relevant assembly number and follow the instructions.

# SHARK

ZAMA

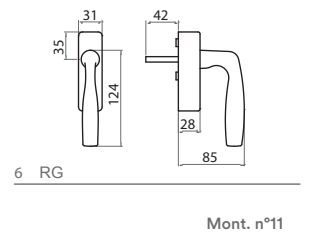
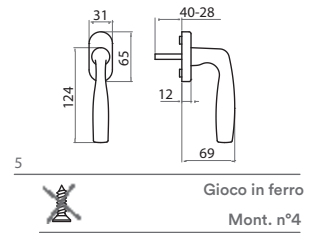
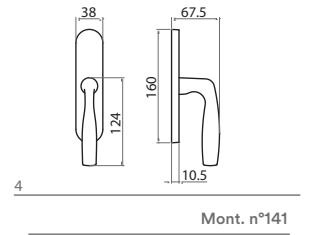

	ZCL	GCTOL	ZCS	ZNS	Conf. Pz.
4 MART IM Martellina Q7 imp. Maniglia lever window handle	66480550007	66480550012	66480550013	66480550027	2
5 DK x 40 C/BUSS 4 scatti Martellina DK Q7 x 40 c/bussole D.9,5 window handle DK x 40 mm with pins D.9,5	66480549507	66480549512	66480549513	66480549527	2
5 DK x 40 C/BUSS 8 scatti Martellina DK Q7 x 40 c/bussole D.9,5 window handle DK x 40 mm with pins D.9,5	6648054950708	6648054951208	6648054951308	6648054952708	2
6 DK x 42 C/CHIAVE C/BUSS. Martellina con chiave DK Q7x42 c/bussole D.9,5 window handle DK x 42mm with key / pins D.9,5	66480563507	66480563512	66480563513	66480563527	1



Per istruzioni di montaggio  
scansiona QR code,  
seleziona il numero di  
riferimento e segui le  
istruzioni.  
For assembly instructions  
scan the QR code, select the  
relevant assembly number  
and follow the instructions.

# SWING

DESIGN FRANCESCO LUCCHESI

ZAMA

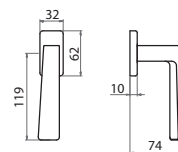

2 DK-1P



Mont. n°6

	ZCL	ZCS	ZNO	Conf. Pz.
2 DK X 40 Martellina DK Q7 x 40 window handle DK x 40 mm	66410555007	66410555013	66410555016	2
2 DK X 40 C/BUSS. Martellina DK Q7 x 40 con bussole D. 9,5 window handle DK x 40mm with pins D.9,5	66410556007	66410556013	66410556016	2



Per istruzioni di montaggio  
scansiona QR code,  
seleziona il numero di  
riferimento e segui le  
istruzioni.  
For assembly instructions  
scan the QR code, select the  
relevant assembly number  
and follow the instructions.





## FINESTRA

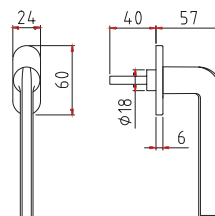

2



Mont. n°5

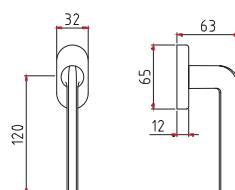

3



Mont. n°4

	ZCS	ZNO	Z-BGO	Z-OSO	Conf. Pz.
2 DK X 40 ribassato Martellina DK Q7 x 40 ribassato window handle DK x 40 mm thin mechanism	R0753596013	R0753596016	R0753596064	R0753596066	2
3 DK X 40 C/BUSS Martellina DK Q7 x 40 con bussole D. 9,5 gioco in ferro window handle DK x 40mm with pins D.9,5 iron mechanism	R075300048213	R075300048216	R075300048264	R075300048266	2



Per istruzioni di montaggio  
scansiona QR code,  
seleziona il numero di  
riferimento e segui le  
istruzioni.  
For assembly instructions  
scan the QR code, select the  
relevant assembly number  
and follow the instructions.



FINESTRA

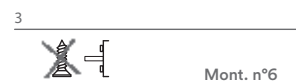
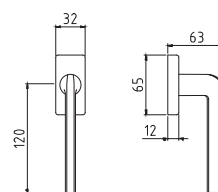
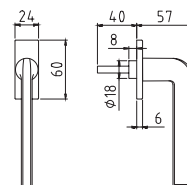

	ZCS	ZNO	Z-BGO	Z-OSO	Conf. Pz.
2 DK X 40 ribassato Martellina DK Q7 x 40 ribassato window handle DK x 40 mm thin mechanism	R0753594013	R0753594016	R0753594064	R0753594066	2
3 DK X 40 C/BUSS Martellina DK Q7 x 40 con bussole D. 9,5 gioco in ferro window handle DK x 40mm with pins D.9,5 iron mechanism	R075300C48213	R075300C48216	R075300C48264	R075300C48266	2



Per istruzioni di montaggio scansiona QR code, seleziona il numero di riferimento e segui le istruzioni.  
For assembly instructions scan the QR code, select the relevant assembly number and follow the instructions.

# UNO Z

ZAMA

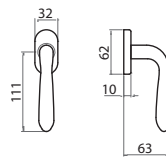

2 DK-2P



Mont. n°8

	ZCL	GCTOL	ZCS	ZNO	ZNS	Conf. Pz.
2 DK X 40 Martellina DK Q7 x 40 window handle DK x 40 mm	66546557007	66546557012	66546557013	66546557016	66546557027	2
2 DK X 40 C/BUSS. Martellina DK Q7 x 40 con bussole D. 9,5 window handle DK x 40mm with pins D.9,5	66546558007	66546558012	66546558013	66546558016	66546558027	2



Per istruzioni di montaggio  
scansiona QR code,  
seleziona il numero di  
riferimento e segui le  
istruzioni.  
For assembly instructions  
scan the QR code, select the  
relevant assembly number  
and follow the instructions.

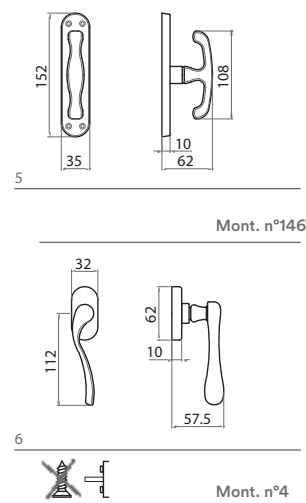

	GCTOL	OLV	ZGV	OGV	Conf. Pz.
5 MART Martellina Q7 window handle		55010500001		55010500004	2
6 DK X 40 Martellina DK Q7 x 40 window handle DK x 40 mm	66246557012		66246557004		2
6 DK X 40 C/BUSS. Martellina DK Q7 x 40 con bussole D. 9,5 window handle DK x 40mm with pins D.9,5	66246558012		66246558004		2



Per istruzioni di montaggio scansiona QR code, seleziona il numero di riferimento e segui le istruzioni.  
For assembly instructions scan the QR code, select the relevant assembly number and follow the instructions.

# WING

ALLUMINIO

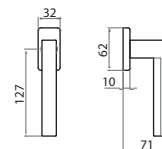

2



Mont. n°6

2 DK x 40  
Martellina DK Q7 x 40  
window handle DK x 40 mm

ACS  
77792555013

ACL  
77792555017

Conf.  
Pz.

2



Per istruzioni di montaggio  
scansiona QR code,  
seleziona il numero di  
riferimento e segui le  
istruzioni.  
For assembly instructions  
scan the QR code, select the  
relevant assembly number  
and follow the instructions.

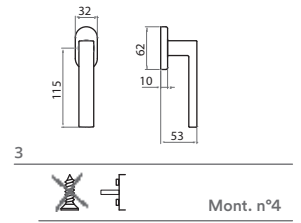

	ZCL	ZCS	ZNS	Conf. Pz.
3 DK X 40 Martellina DK Q7 x 40 window handle DK x 40 mm	66460567007	66460567013	66460567027	2
3 DK X 40 C/BUSS. Martellina DK Q7 x 40 con bussole D. 9,5 window handle DK x 40mm with pins D.9,5	66460568007	66460568013	66460568027	2



Per istruzioni di montaggio  
scansiona QR code,  
seleziona il numero di  
riferimento e segui le  
istruzioni.  
For assembly instructions  
scan the QR code, select the  
relevant assembly number  
and follow the instructions.

# YORK BERRY

ZAMA

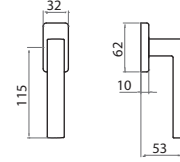

3



Mont. n°6

		CHAMPAGNE	NORMANDIA	LORENA	BORGOGNA	Conf. Pz.
3	DK X 40 Martellina DK Q7 x 40 window handle DK x 40 mm	66460557043	66460557044	66460557046	66460557047	2
3	DK X 40 C/BUSS. Martellina DK Q7 x 40 con bussole D. 9,5 window handle DK x 40mm with pins D.9,5	66460558043	66460558044	66460558046	66460558047	2



Per istruzioni di montaggio  
scansiona QR code,  
seleziona il numero di  
riferimento e segui le  
istruzioni.  
For assembly instructions  
scan the QR code, select the  
relevant assembly number  
and follow the instructions.

# YORK Q

ZAMA

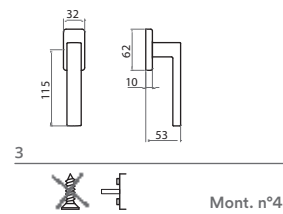

	ZCL	ZCS	ZNO	ZNS	Conf. Pz.
3 DK X 40 Martellina DK Q7 x 40 window handle DK x 40 mm	66460557007	66460557013	66460557016	66460557027	2
3 DK X 40 C/BUSS. Martellina DK Q7 x 40 con bussole D. 9,5 window handle DK x 40mm with pins D.9,5	66460558007	66460558013	66460558016	66460558027	2



Per istruzioni di montaggio scansiona QR code, seleziona il numero di riferimento e segui le istruzioni.  
For assembly instructions scan the QR code, select the relevant assembly number and follow the instructions.



# BAROCCO

OTTONE

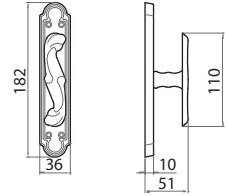

2

Mont. n°147

		OBR	Conf. Pz.
2	GZ Cremonese gioco GZ Mechanism for window handle spindle 7 mm	44290401000	10
2	GZP Cremonese gioco GZ + PERNI Mechanism for window handle spindle 7 mm	44290402000	10
2	GZQ7 Cremonese gioco GZ + Q7 Mechanism for window handle spindle 7 mm	44290403000	10
2	MART Martellina Q7 window handle	44290500000	10



Per istruzioni di montaggio  
scansiona QR code,  
seleziona il numero di  
riferimento e segui le  
istruzioni.  
For assembly instructions  
scan the QR code, select the  
relevant assembly number  
and follow the instructions.

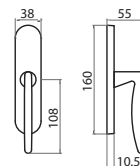

3

Mont. n°140-141

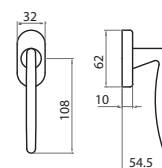

4



Mont. n°8

	OLV	OCS	OCL	Conf. Pz.
3 EZ IM Cremonese gioco EZ imp. maniglia Mechanism for window handle spindle 7 mm	55014456001	55014456003	55014456007	2
3 EZQ7 IM Cremonese gioco EZ + Q7 imp. maniglia Mechanism for window handle spindle 7 mm	55014457001	55014457003	55014457007	2
3 MART IM Martellina Q7 imp. Maniglia lever window handle	55014550001	55014550003	55014550007	2
4 DK X 40 Martellina DK Q7 x 40 window handle DK x 40 mm	55014557001	55014557003	55014557007	2
4 DK X 40 C/BUSS Martellina DK Q7 x 40 con bussole D. 9,5 window handle DK x 40mm with pins D.9,5	55014558001	55014558003	55014558007	2



Per istruzioni di montaggio scansiona QR code, seleziona il numero di riferimento e segui le istruzioni.  
For assembly instructions scan the QR code, select the relevant assembly number and follow the instructions.

# EASY Q

OTTONE

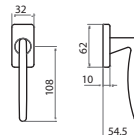

2



Mont. n°9

	OLV	OCS	OCL	Conf. Pz.
2 DK X 40-35 Martellina DK Q7 x 40 window handle DK x 40 mm	55062557001	55062557003	55062557007	2
2 DK X 40-35 C/BUSS. Martellina DK Q7 x 40 con bussole D. 9,5 window handle DK x 40mm with pins D.9,5	55062558001	55062558003	55062558007	2



Per istruzioni di montaggio  
scansiona QR code,  
seleziona il numero di  
riferimento e segui le  
istruzioni.  
For assembly instructions  
scan the QR code, select the  
relevant assembly number  
and follow the instructions.

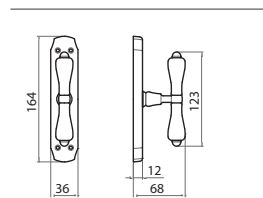

4

Mont. n°146

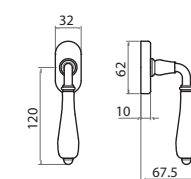

5



Mont. n°4

	OBR	OLV	OLD	Conf. Pz.
4 MART Martellina Q7 window handle	55194500000	55194500001	55194500028	2
5 DK X 40 Martellina DK Q7 x 40 window handle DK x 40 mm	55194557000	55194557001	55194557028	2
5 DK X 40 C/BUSS. Martellina DK Q7 x 40 con bussole D. 9,5 window handle DK x 40mm with pins D.9,5	55194558000	55194558001	55194558028	2



Per istruzioni di montaggio scansiona QR code, seleziona il numero di riferimento e segui le istruzioni.  
For assembly instructions scan the QR code, select the relevant assembly number and follow the instructions.

# GINEVRA

OTTONE

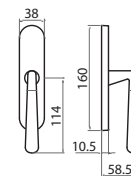

3

Mont. n°140-141

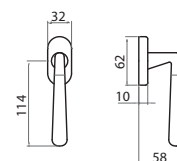

4



Mont. n°8

	OLS	OCL/OCS	Conf. Pz.
3 EZ IM Cremonese gioco EZ imp. maniglia Mechanism for window handle spindle 7 mm	55846456002	5584645600703	2
3 EZQ7 IM Cremonese gioco EZ + Q7 imp. maniglia Mechanism for window handle spindle 7 mm	55846457002	5584645700703	2
3 MART IM Martellina Q7 imp. Maniglia lever window handle	55846550002	5584655000703	2
4 DK x 40-35 Martellina DK Q7 x 40 window handle DK x 40 mm	55846557002	5584655700703	2
4 DK x 40-35 C/BUSS. Martellina DK Q7 x 40 con bussole D. 9,5 window handle DK x 40mm with pins D.9,5	55846558002	5584655800703	2



Per istruzioni di montaggio  
scansiona QR code,  
seleziona il numero di  
riferimento e segui le  
istruzioni.

For assembly instructions  
scan the QR code, select the  
relevant assembly number  
and follow the instructions.

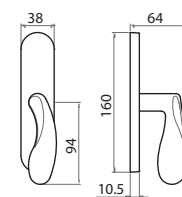

3

Mont. n°140-141

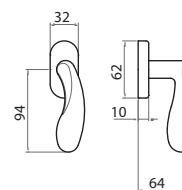

4



Mont. n°4

	OLV	OCS	OCL	Conf. Pz.
3 EZ IM Cremonese gioco EZ imp. maniglia Mechanism for window handle spindle 7 mm	55146456001	55146456003	55146456007	2
3 EZQ7 IM Cremonese gioco EZ + Q7 imp. maniglia Mechanism for window handle spindle 7 mm	55146457001	55146457003	55146457007	2
3 MART IM Martellina Q7 imp. Maniglia lever window handle	55146550001	55146550003	55146550007	2
4 DK X 40 Martellina DK Q7 x 40 window handle DK x 40 mm	55146557001	55146557003	55146557007	2



Per istruzioni di montaggio  
scansiona QR code,  
seleziona il numero di  
riferimento e segui le  
istruzioni.  
For assembly instructions  
scan the QR code, select the  
relevant assembly number  
and follow the instructions.

# LADY

OTTONE

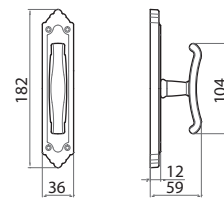

2

Mont. n°147

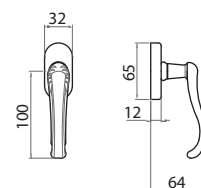

3



Mont. n°4

		OF	Conf. Pz.
2	GZ Cremonese gioco GZ Mechanism for window handle spindle 7 mm	44394401006	6
2	GZP Cremonese gioco GZ + PERNI Mechanism for window handle spindle 7 mm	44394402006	6
2	GZQ7 Cremonese gioco GZ + Q7 Mechanism for window handle spindle 7 mm	44394403006	6
3	MART Martellina Q7 window handle	44394500006	6
3	DK x 40 Martellina DK Q7 x 40 window handle DK x 40 mm	44394555006	2



Per istruzioni di montaggio  
scansiona QR code,  
seleziona il numero di  
riferimento e segui le  
istruzioni.  
For assembly instructions  
scan the QR code, select the  
relevant assembly number  
and follow the instructions.

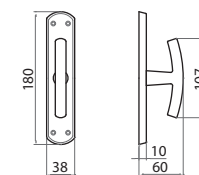

5

Mont. n°145-146

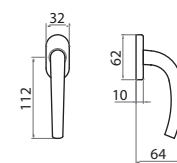

6



Mont. n°8

	OLV	OCS	OGV	OCL	OS	Conf. Pz.
5 EZ Cremonese gioco EZ Mechanism for window handle spindle 7 mm	55744406001	55744406003	55744406004	55744406007	55744406008	2
5 EZQ7 Cremonese gioco EZ + Q7 Mechanism for window handle spindle 7 mm	55744407001	55744407003	55744407004	55744407007	55744407008	2
5 MART Martellina Q7 window handle	55744500001	55744500003	55744500004	55744500007	55744500008	2
6 DK x 40-35 Martellina DK Q7 x 40-35 window handle DK x 40-35mm	55744577001	55744577003	55744577004	55744577007	55744577008	2
6 DK x 40-35 C/BUSS Martellina DK Q7 x 40-35 con bussole window handle DK x 40-35 mm with pins D.9,5	55744578001	55744578003	55744578004	55744578007	55744578008	2



Per istruzioni di montaggio scansiona QR code, seleziona il numero di riferimento e segui le istruzioni.  
For assembly instructions scan the QR code, select the relevant assembly number and follow the instructions.



# NOVECENTO

OTTONE

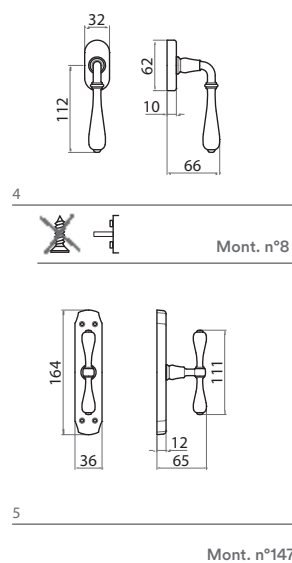

	OBR	OLV	OCL	OLD	OFA	Conf. Pz.
4 MART Martellina Q7 window handle	55196500000	55196500001	55196500007	55196500028	55196500029	2
5 DK x 40-35 Martellina DK Q7 x 40-35 window handle DK x 40-35mm	55196577000	55196577001	55196577007	55196577028	55196577029	2
5 DK x 40-35 C/BUSS Martellina DK Q7 x 40-35 con bussole window handle DK x 40-35 mm with pins D.9,5	55196578000	55196578001	55196578007	55196578028	55196578029	2



Per istruzioni di montaggio scansiona QR code, seleziona il numero di riferimento e segui le istruzioni.  
For assembly instructions scan the QR code, select the relevant assembly number and follow the instructions.

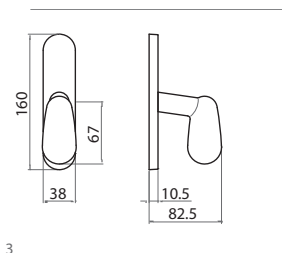

3

Mont. n°140-141

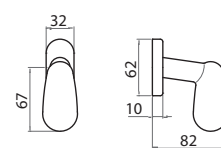

4



Mont. n°4

	OLV	OCS	OCL	Conf. Pz.
3 EZ IM Cremonese gioco EZ imp. maniglia Mechanism for window handle spindle 7 mm	55442456001	55442456003	55442456007	2
3 EZQ7 IM Cremonese gioco EZ + Q7 imp. maniglia Mechanism for window handle spindle 7 mm	55442457001	55442457003	55442457007	2
3 MART IM Martellina Q7 imp. Maniglia lever window handle	55442550001	55442550003	55442550007	2
4 DK X 40 Martellina DK Q7 x 40 window handle DK x 40 mm	55442557001	55442557003	55442557007	2
4 DK X 40 C/BUSS. Martellina DK Q7 x 40 con bussole D. 9,5 window handle DK x 40mm with pins D.9,5	55442558001	55442558003	55442558007	2



Per istruzioni di montaggio scansiona QR code, seleziona il numero di riferimento e segui le istruzioni.  
For assembly instructions scan the QR code, select the relevant assembly number and follow the instructions.

# R5200

OTTONE

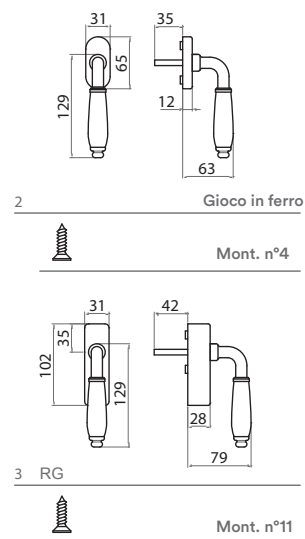

	OCS-PB	OCL-PB	OFA-NO	ONL-NO	Conf. Pz.
2 DK x 35 VM C/BUSS. Martellina DK Q7x35 c/bussole D.9,5 mm viti metriche window handle DK x 35 mm with pins D.9,5 metric screws	R5200000480C390	R5200000480C790	R5200000480UF90	R5200000480UN90	1
3 DK x 42 C/CHIAVE VM C/BUSS. Martellina con chiave DK Q7x42 c/bussole D.9,5 mm viti metriche window handle DK x 42mm with key / pins D.9,5 with screws	R520000A484C390	R520000A484C790	R520000A484UF90	R520000A484UN90	1



Per istruzioni di montaggio scansiona QR code, seleziona il numero di riferimento e segui le istruzioni.  
For assembly instructions scan the QR code, select the relevant assembly number and follow the instructions.

# R716

OTTONE

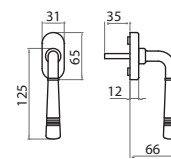

2 | Gioco in ferro



Mont. n°4

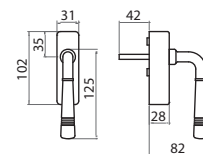

3 | RG



Mont. n°11

	OLV	OCL	ONS	OLD	OFA	OANT	Conf. Pz.
2 DK x 35 C/BUSS. Martellina DK Q7x35 c/bussole D.9,5 mm viti metriche window handle DK x 35 mm with pins D.9,5 metric screws	R07160004800190	R07160004800790	R07160004802790	R07160004802890	R07160004802990	R07160004804290	1
3 DK x 42 C/CHIAVE C/BUSS. Martellina con chiave DK Q7x42 c/bussole D.9,5 mm viti metric window handle DK x 42mm with key / pins D.9,5 with screws	R071600A4840190	R071600A4840790	R071600A4842790	R071600A4842890	R071600A4842990	R071600A4844290	1



Per istruzioni di montaggio scansiona QR code, seleziona il numero di riferimento e segui le istruzioni.  
For assembly instructions scan the QR code, select the relevant assembly number and follow the instructions.

# R771

OTTONE

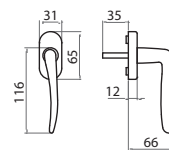
2 [ **Gioco in ferro**

Mont. n°4

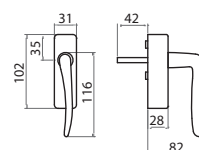

3 RG



Mont. n°11

	OLV	OCS	OCL	ONS	Conf. Pz.
3 DK x 35 C/BUSS. Martellina DK Q7x35 c/bussola D.9,5 mm viti metriche window handle DK x 35 mm with pins D.9,5 metric screws	R07710004800190	R07710004800390	R07710004800790	R07710004802790	1
4 DK x 42 C/CHIAVE C/BUSS. Martellina con chiave DK Q7x42 c/bus D.9,5 mm viti metr window handle DK x 42mm with key / pins D.9,5 with screws	R077100A4840190	R077100A4840390	R077100A4840790	R077100A4842790	1



Per istruzioni di montaggio  
scansiona QR code,  
seleziona il numero di  
riferimento e segui le  
istruzioni.  
For assembly instructions  
scan the QR code, select the  
relevant assembly number  
and follow the instructions.

# R775

OTTONE

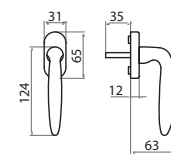

2 I Gioco in ferro



Mont. n°4

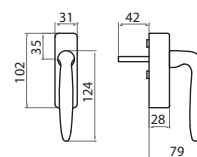

3 RG



Mont. n°11

	ZCL	GCTOL	ZCS	ZNS	Conf. Pz.
2 DK x 35 C/BUSS. Martellina DK Q7x35 c/bussole D.9,5 mm viti metriche window handle DK x 35 mm with pins D.9,5 metric screws	R07750004800790	R07750004801290	R07750004801390	R07750004802790	1
3 DK x 42 C/CHIAVE C/BUSS. Martellina con chiave DK Q7x42 c/bussole D.9,5 mm viti metriche window handle DK x 42mm with key / pins D.9,5 with screws	R077500A4840790	R077500A4841290	R077500A4841390	R077500A4842790	1



Per istruzioni di montaggio scansiona QR code, seleziona il numero di riferimento e segui le istruzioni.  
For assembly instructions scan the QR code, select the relevant assembly number and follow the instructions.

# R901

OTTONE

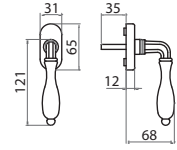

2 Gioco in ferro



Mont. n°4

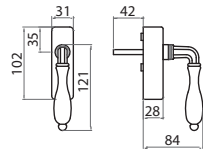

3 RG



Mont. n°11

	OLV	OCL	OLD	OFA	OANT	Conf. Pz.
2 DK x 35 VM C/BUSS. Martellina DK Q7x35 c/bussola D.9,5 mm viti metriche window handle DK x 35 mm with pins D.9.5 metric screws	R09010004800190	R09010004800790	R09010004802890	R09010004802990	R09010004804290	1
3 DK x 42 C/CHIAVE VM C/BUSS. Martellina con chiave DK Q7x42 c/bussola D.9,5 mm viti metriche window handle DK x 42mm with key / pins D.9.5 with screws	R090100A4840190	R090100A4840790	R090100A4842890	R090100A4842990	R090100A4844290	1



Per istruzioni di montaggio  
scansiona QR code,  
seleziona il numero di  
riferimento e segui le  
istruzioni.  
For assembly instructions  
scan the QR code, select the  
relevant assembly number  
and follow the instructions.

# R988

OTTONE

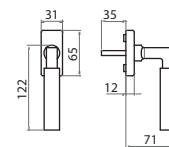

2 Gioco in ferro



Mont. n°4

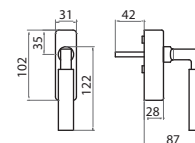

3 RG



Mont. n°11

	OCS	OCL	ONS	ONL	OCL-EB	ONL-EB	Conf. Pz.
2 DK X 35 C/BUSS. Martellina DK Q7x35 c/bussole D.9,5 mm viti metriche window handle DK x 35 mm with pins D.9,5 metric screws	R098800C4800390	R098800C4800790	R098800C4802790	R098800C4803090	R098800C480E790	R098800C480EN90	1
3 DK X 42 C/CHIAVE C/BUSS Martellina con chiave DK Q7x42 c/bussole D.9,5 mm viti metric window handle DK x 42mm with key / pins D.9,5 with screws	R098800A4840390	R098800A4840790	R098800A4842790	R098800A4843090	R098800A484E790	R098800A484EN90	1



Per istruzioni di montaggio scansiona QR code, seleziona il numero di riferimento e segui le istruzioni.  
For assembly instructions scan the QR code, select the relevant assembly number and follow the instructions.



# UNO

OTTONE

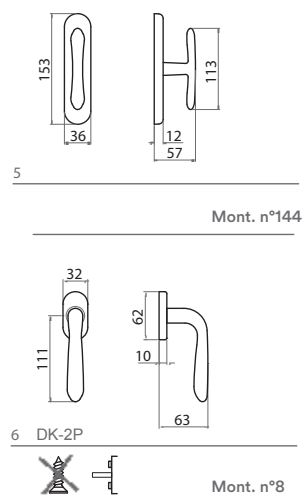

	OLV	OCS	OGV	OCL	Conf. Pz.
3 CREM/MART SG Cremonese-martellina Q7 senza gioco Window handle without mechanism	55796400001	55796400003	55796400004	55796400007	2
3 DK X 40 Martellina DK Q7 x 40 window handle DK x 40 mm	55796557001	55796557003	55796557004	55796557007	2
3 DK X 40 C/BUSS. Martellina DK Q7 x 40 con bussole D. 9,5 window handle DK x 40mm with pins D.9,5	55796558001	55796558003	55796558004	55796558007	2



Per istruzioni di montaggio  
scansiona QR code,  
seleziona il numero di  
riferimento e segui le  
istruzioni.  
For assembly instructions  
scan the QR code, select the  
relevant assembly number  
and follow the instructions.

# GIOCHI PER CREMONESI

FERRO

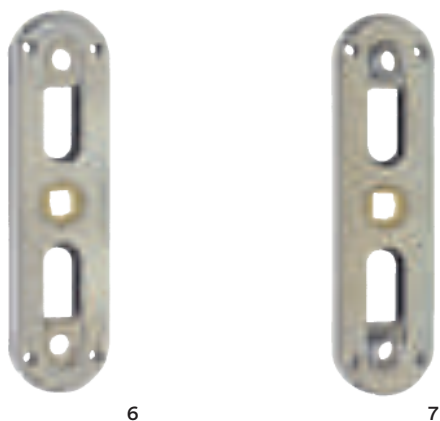

	ZB	Conf. Pz.
1 GIOCO MARTELLINA Q.7 Gioco martellina Q.7 Window mechanism	13350000070	10
2 GIOCO EZ Gioco EZ Window mechanism	13340600070	10
3 GIOCO EZ Q.7 Gioco EZ Q.7 Window mechanism	13340700070	10
4 GIOCO GRAZ PERNI Gioco graz perni Window mechanism	13340200070	10
5 GIOCO GRAZ PERNI Q.7 Gioco graz perni Q.7 Window mechanism	13340900070	10
6 GIOCO GRAZ JOLLY DA APPLICARE Gioco graz jolly da applicare Window mechanism	13341005070	10
7 GIOCO EZ JOLLY DA APPLICARE Gioco EZ jolly da applicare Window mechanism	13341105070	10

# 7900

ALLUMINIO

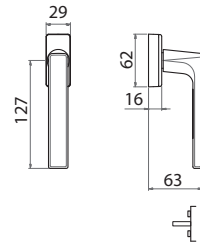

5 Mont. n°14

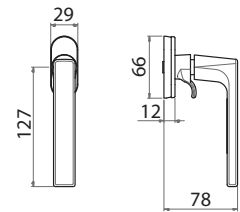

6 Mont. n°15

	F1	F3	F4	F9	Conf. Pz.
5 DK40-35 BUS, 9,5 7900 GHTEK DK40-35 BUS, 9,5 window handle DK x 40mm with pins D.9,5	77900583001	77900583003	77900583004	77900583009	20
6 DK X 40 BUS, 9,5 SECURPULL Martellina DK Q7 x 40 BUSS. 9,5 SECURPULL window handle DK x 40 mm with pins D.9,5 SECURPULL	77900575001	77900575003	77900575004	77900575009	20

	RAL9010	GCTOL	ANO	F1-SAT	Conf. Pz.
5 DK40-35 BUS, 9,5 7900 GHTEK DK40-35 BUS, 9,5 window handle DK x 40mm with pins D.9,5	77900583007	77900583012	77900583016	77900583033	20
6 DK X 40 BUS, 9,5 SECURPULL 7900 DK Q7 x 40 BUSS. 9,5 SECURPULL window handle DK x 40 mm with pins D.9,5 SECURPULL	77900575007	77900575012	77900575016	77900575033	20



Per istruzioni di montaggio  
scansiona QR code,  
seleziona il numero di  
riferimento e segui le  
istruzioni.  
For assembly instructions  
scan the QR code, select the  
relevant assembly number  
and follow the instructions.

# ARCHIMEDE

ALLUMINIO

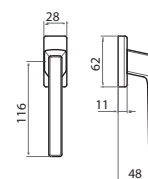

2



Mont. n°10

	F1-SAT	Conf. Pz.
2 DK x 40 Martellina DK Q7 x 40 window handle DK x 40 mm	77696555033	2
2 DK X 40 C/BUS Martellina DK Q7 x 40 con bussole D. 9,5 window handle DK x 40mm with pins D.9,5	77696556033	2

	F1	F3	Conf. Pz.	
2 DK X 33 C/BUSS D.9,5 ARCHIMEDE DKx33 8SC BUS. 9,5 window handle DK x 33mm with pins D.9,5	7400855830158	7400855830358	7400855830458	100
2 DK X 35 C/BUSS D.9,5 ARCHIMEDE DKx35 8SC BUS. 9,5 window handle DK x 35 mm with pins D.9,5	7400855850158	7400855850358	7400855850458	100
2 DK X 40 C/BUSS D.9,5 ARCHIMEDE DKx40 8SC BUS. 9,5 window handle DK x 40 mm with pins D.9,5	7408855800158	7400855800358	7400855800458	100
2 DK X 45 C/BUSS D.9,5 ARCHIMEDE DKx45 8SC BUS. 9,5 window handle DK x 45 mm with pins D.9,5	7408855840158	7400855840358	7400855840458	100



Per istruzioni di montaggio scansiona QR code, seleziona il numero di riferimento e segui le istruzioni.  
For assembly instructions scan the QR code, select the relevant assembly number and follow the instructions.

# BRIXIA

ALLUMINIO

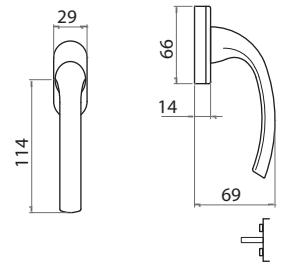

6

Mont. n°12

	F1	F3	F4	F9	Conf. Pz.
6 DKx33 8SC BUS. 9,6 BRIXIA DKx33 8SC BUS. 9,5	7743855830158	7743855830358	7743855830458	7743855830958	100
6 DKx35 8SC BUS. 9,6 BRIXIA DKx35 8SC BUS. 9,5	7743855850158	7743855850358	7743855850458	7743855850958	100
6 DKx40 8SC BUS. 9,6 BRIXIA DKx40 8SC BUS. 9,5	7743855800158	7743855800358	7743855800458	7743855800958	100
6 DKx45 8SC BUS. 9,6 BRIXIA DKx45 8SC BUS. 9,5	7743855840158	7743855840358	7743855840458	7743855840958	100
	RAL9010	RAL1013	ANO	RAL9016	Conf. Pz.
6 DKx33 8SC BUS. 9,6 BRIXIA DKx33 8SC BUS. 9,5	7743855830758	7743855831058	7743855831658	7743855838058	100
6 DKx35 8SC BUS. 9,6 BRIXIA DKx35 8SC BUS. 9,5	7743855850758	7743855851058	7743855851658	7743855858058	100
6 DKx40 8SC BUS. 9,6 BRIXIA DKx40 8SC BUS. 9,5	7743855800758	7743855801058	7743855801658	7743855808058	100
6 DKx45 8SC BUS. 9,6 BRIXIA DKx45 8SC BUS. 9,5	7743855840758	7743855841058	7743855841658	7743855848058	100



Per istruzioni di montaggio  
scansiona QR code,  
seleziona il numero di  
riferimento e segui le  
istruzioni.  
For assembly instructions  
scan the QR code, select the  
relevant assembly number  
and follow the instructions.

# BRIXIA 2

ALLUMINIO

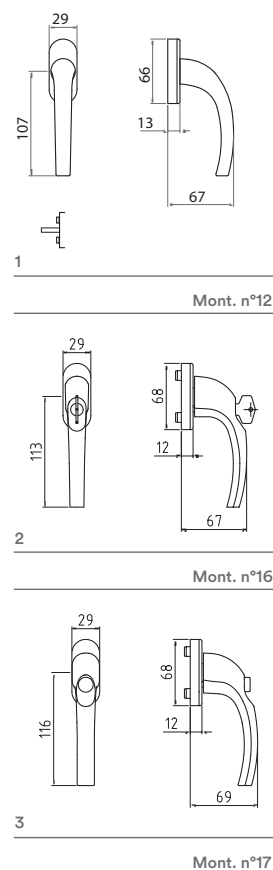

	F1	F3	F4	Conf. Pz.
1 DKx33 8SC BUS. 9,5 BRIXIA/2 DKx33 8SC BUS. 9,5 window handle DK x 33mm with pins D.9,5	7743355830158	7743355830358	7743355830458	100
1 DKx35 8SC BUS. 9,5 BRIXIA/2 DKx35 8SC BUS. 9,5 window handle DK x 35mm with pins D.9,5	7743355850158	7743355850358	7743355850458	100
1 DKx40 8SC BUS. 9,5 BRIXIA/2 DKx40 8SC BUS. 9,5 window handle DK x 40mm with pins D.9,5	7743355800158	7743355800358	7743355800458	100
1 DKx45 8SC BUS. 9,5 BRIXIA/2 DKx45 8SC BUS. 9,5 window handle DK x 45mm with pins D.9,5	7743355840158	7743355840358	7743355840458	100
2 DK X 40 C/BUSS D.9,5 BRIXIA/2 con chiave DK Q7 x 40 con bussole D. 9,5 window handle DK x 40mm with pins D.9,5	77433563501	77433563503	77433563504	5
3 DK X 40 C/BUSS D.9,5 BRIXIA/2 con pulsante DK Q7 x 40 con bussole D. 9,5 window handle DK x 40mm with pins D.9,5	77433562501	77433562503	77433562504	5

	RAL9010	RAL1013	ANO	RAL9016	Conf. Pz.
1 DKx33 8SC BUS. 9,5 BRIXIA/2 DKx33 8SC BUS. 9,5 window handle DK x 33mm with pins D.9,5	7743355830758	7743355831058	7743355831658	7743355838058	100
1 DKx35 8SC BUS. 9,5 BRIXIA/2 DKx35 8SC BUS. 9,5 window handle DK x 35mm with pins D.9,5	7743355850758	7743355851058	7743355851658	7743355858058	100
1 DKx40 8SC BUS. 9,5 BRIXIA/2 DKx40 8SC BUS. 9,5 window handle DK x 40mm with pins D.9,5	7743355800758	7743355801058	7743355801658	7743355808058	100
1 DKx45 8SC BUS. 9,5 BRIXIA/2 DKx45 8SC BUS. 9,5 window handle DK x 45mm with pins D.9,5	7743355840758	7743355841058	7743355841658	7743355848058	100
2 DK X 40 C/BUSS D.9,5 BRIXIA/2 con chiave DK Q7 x 40 con bussole D. 9,5 window handle DK x 40mm with pins D.9,5	77433563607	77433563510	77433563516	77433563580	5
3 DK X 40 C/BUSS D.9,5 BRIXIA/2 con pulsante DK Q7 x 40 con bussole D. 9,5 window handle DK x 40mm with pins D.9,5	77433562507	77433562510	77433562516	77433562580	5

# CARLO

ALLUMINIO

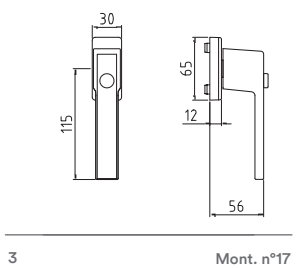
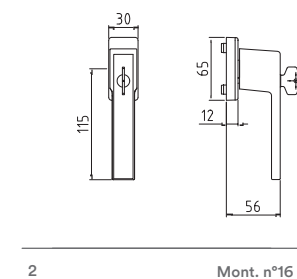
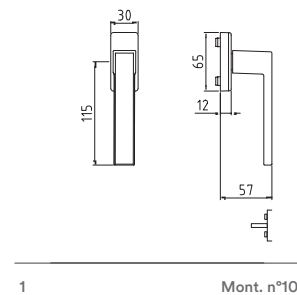

	F1	F3	F4	F9	Conf. Pz.
1 DK X 35 C/BUSS D.9,5 CARLO DKX35 8SC RET BUS.9,5 window handle DK x 35mm with pins D.9,5	7750255650108	7750255650308	7750255650408	7750255650908	100
1 DK X 40 C/BUSS D.9,5 CARLO DK Q7 x 40 con bussole D. 9,5 window handle DK x 40mm with pins D.9,5	7750255600108	7750255600308	7750255600408	7750255600908	20
1 DK X 45 C/BUSS D.9,5 CARLO DKX45 8SC RET BUS.9,5 window handle DK x 45mm with pins D.9,5	7750255640108	7750255640308	7750255640408	7750255640908	100
1 DK X 50 C/BUSS D.9,5 CARLO DKX50 8SC RET BUS.9,5 window handle DK x 50mm with pins D.9,5	7750255660108	7750255660308	7750255660408	7750255660908	100
2 DK X 45 C/BUSS D.9,5 CARLO con chiave DK Q7 x 45 con bussole D. 9,5 window handle DK x 45mm with pins D.9,5	77502563301	77502563303	77502563304	77502563309	5
2 DK X 40 C/BUSS D.9,5 CARLO con chiave DK Q7 x 40 con bussole D. 9,5 window handle DK x 40mm with pins D.9,5	77502563501	77502563503	77502563504		5
3 DK X 40 C/BUSS D.9,5 CARLO con pulsante DK Q7 x 40 con bussole D. 9,5 window handle DK x 40mm with pins D.9,5	77502562501	77502562503	77502562504	77502562509	5
	RAL9010	RAL1013	ANO	RAL9016	Conf. Pz.
1 DK X 35 C/BUSS D.9,5 CARLO DKX35 8SC RET BUS.9,5 window handle DK x 35mm with pins D.9,5	7750255650708	7750255651008	7750255651608	7750255658008	100
1 DK X 40 C/BUSS D.9,5 CARLO DK Q7 x 40 con bussole D. 9,5 window handle DK x 40mm with pins D.9,5	7750255600708	7750255601008	7750255601608	7750255608008	20
1 DK X 45 C/BUSS D.9,5 CARLO DKX45 8SC RET BUS.9,5 window handle DK x 45mm with pins D.9,5	7750255640708	7750255641008	7750255641608	7750255648008	100
1 DK X 50 C/BUSS D.9,5 CARLO DKX50 8SC RET BUS.9,5 window handle DK x 50mm with pins D.9,5	7750255660708	7750255661008	7750255661608	7750255668008	100
2 DK X 45 C/BUSS D.9,5 CARLO con chiave DK Q7 x 45 con bussole D. 9,5 window handle DK x 45mm with pins D.9,5	77502563307	77502563310	77502563316	77502563380	5
2 DK X 40 C/BUSS D.9,5 CARLO con chiave DK Q7 x 40 con bussole D. 9,5 window handle DK x 40mm with pins D.9,5	77502563507	77502563510	77502563516	77502563580	5
3 DK X 40 C/BUSS D.9,5 CARLO con pulsante DK Q7 x 40 con bussole D. 9,5 window handle DK x 40mm with pins D.9,5	77502562507	77502562510	77502562516	77502562580	5

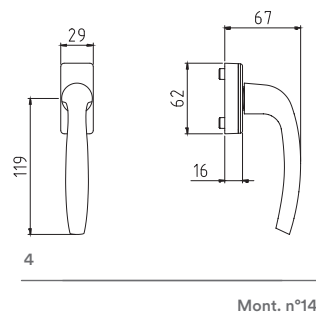
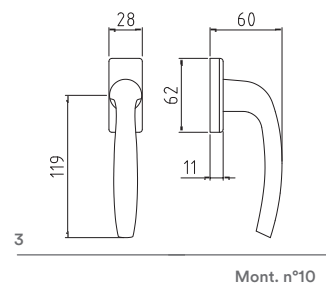

	F1	F3	F4	RAL9010	F9	ANO	Conf. Pz.
3 DK x 45 C/BUSS D.9,5 DELTA DK X 45 C/BUSS D.9,5 window handle DK x 45 mm with pins D.9,5	7721055600158	7721055600358	7721055600458	7721055600758	7721055600958	7721055601658	100
4 DK X 45 BUS. 9,5 GHTECH DELTA DK X 45 BUS. 9,5 GHTECH window handle DK x 45 mm with pins D.9,5 GHTECH	77210583001	77210583003	77210583004	77210583007	77210583009	77210583016	10



Per istruzioni di montaggio  
scansiona QR code,  
seleziona il numero di  
riferimento e segui le  
istruzioni.  
For assembly instructions  
scan the QR code, select the  
relevant assembly number  
and follow the instructions.



# FLY 24

ALLUMINIO

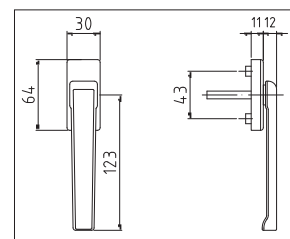

1

Mont. n°12

1 DKx40 FLY 24  
Martellina FLY 24 DK Q7 x 40 con bussole D. 9,5  
window handle DK

F1 F4 Conf.  
7747955600108 7747955600408 Pz.



Per istruzioni di montaggio  
scansiona QR code,  
seleziona il numero di  
riferimento e segui le  
istruzioni.  
For assembly instructions  
scan the QR code, select the  
relevant assembly number  
and follow the instructions.

# FLY SCREEN

ALLUMINIO

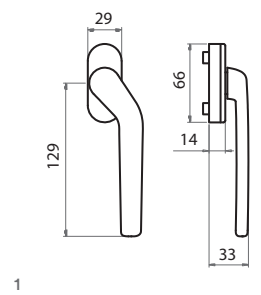

1

Mont. n°12

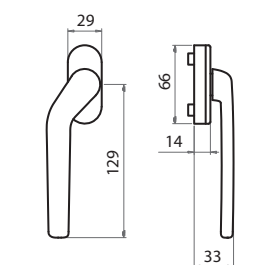

2

Mont. n°12

	F1	F4	Conf. Pz.
1 DK X 40 FLY SCREEN Martellina FLY SCREEN DX DK Q7 x 40 con bussole D. 9,5 window handle DX DK x 40mm FLY SCREEN	77478558001	77478558004	20
2 DK X 40 FLY SCREEN Martellina FLY SCREEN SX DK Q7 x 40 con bussole D. 9,5 window handle SX DK x 40mm FLY SCREEN	77478559001	77478559004	20



Per istruzioni di montaggio  
scansiona QR code,  
seleziona il numero di  
riferimento e segui le  
istruzioni.  
For assembly instructions  
scan the QR code, select the  
relevant assembly number  
and follow the instructions.

# GABRY

ALLUMINIO

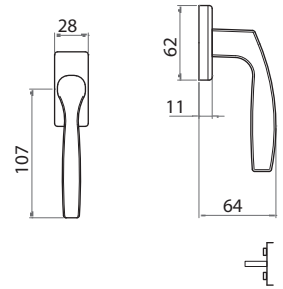

1

Mont. n°10

	F1	F3	F4	Conf. Pz.
1 DK X 33 C/BUSS D.9,5 GABRY TN DKx33 RETT BUS window handle DK x 33mm with pins D.9,5	7740055600158	7740055600358	7740055600458	100
1 DK X 35 C/BUSS D.9,5 GABRY TN DKx35 RETT BUS window handle DK x 35mm with pins D.9,5	7740055650158	7740055650358	7740055650458	100
1 DK X 40 C/BUSS D.9,5 GABRY TN DKx40 RETT BUS window handle DK x 40mm with pins D.9,5	7740055630158	7740055630358	7740055630458	100
1 DK X 45 C/BUSS D.9,5 GABRY TN DKx45 RETT BUS window handle DK x 45mm with pins D.9,5	7740055640158	7740055640358	7740055640458	100



Per istruzioni di montaggio  
scansiona QR code,  
seleziona il numero di  
riferimento e segui le  
istruzioni.  
For assembly instructions  
scan the QR code, select the  
relevant assembly number  
and follow the instructions.

# 2005 ITACA

ALLUMINIO

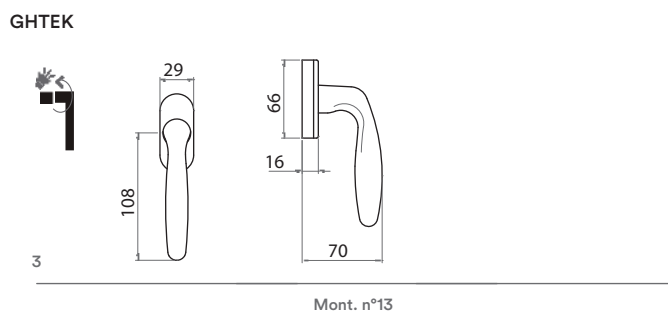
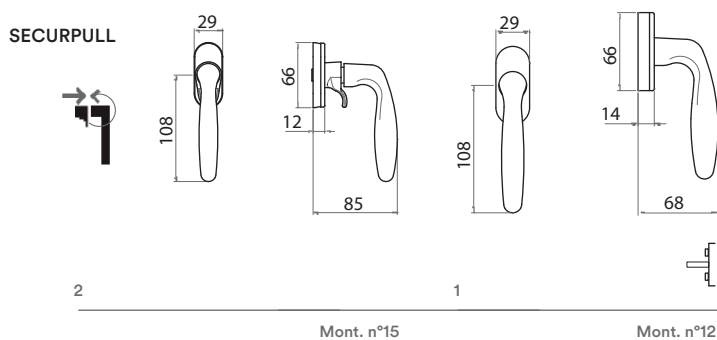

		F1	F3	F4	F9	Conf. Pz.
1	DK X 33 C/BUSS D.9,5 ITACA DKX33 BUS window handle DK x 33mm with pins D.9,5	7200555830158	7200555830358	7200555830458	7200555830958	100
1	DK X 35 C/BUSS D.9,5 ITACA DKX35 BUS window handle DK x 35mm with pins D.9,5	7200555850158	7200555850358	7200555850458	7200555850958	100
1	DK X 40 C/BUSS D.9,5 ITACA DKX40 BUS window handle DK x 40mm with pins D.9,5	7200555800158	7200555800358	7200555800458	7200555800958	100
1	DK X 45 C/BUSS D.9,5 ITACA DKX45 BUS window handle DK x 45mm with pins D.9,5	7200555840158	7200555840358	7200555840458	7200555840958	100
2	DK X 40 SECURPULL ITACA SECURPULL DK40 window handle DK x 40mm SECURPULL	72005575001	72005575003	72005575004	72005575009	20
3	DK X 40-35 GHTECH ITACA GHTEK DK40-35 window handle DK x 40mm GHTECH	72005574001	72005574003	72005574004	72005574009	20



Per istruzioni di montaggio scansiona QR code, seleziona il numero di riferimento e segui le istruzioni.  
For assembly instructions scan the QR code, select the relevant assembly number and follow the instructions.

# KEY

ALLUMINIO

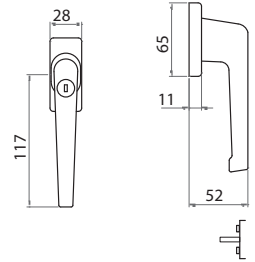

Mont. n°16

	F1	F3	F4	Conf. Pz.
3 DK X 33 C/BUSS D.9,5 KEY DKx33 RETT BUS window handle DK x 33mm with pins D.9,5	77062556001	77062556003	77062556004	10



Per istruzioni di montaggio  
scansiona QR code,  
seleziona il numero di  
riferimento e segui le  
istruzioni.  
For assembly instructions  
scan the QR code, select the  
relevant assembly number  
and follow the instructions.

# ROOF

ALLUMINIO

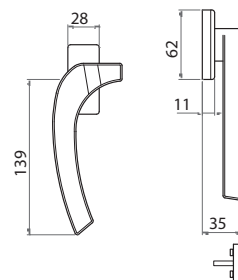

Mont. n°10

3 DK S/FERRO  
ROOF DK S/F  
window handle DK

ACH Conf.  
77040554521 Pz.  
20



Per istruzioni di montaggio  
scansiona QR code,  
seleziona il numero di  
riferimento e segui le  
istruzioni.  
For assembly instructions  
scan the QR code, select the  
relevant assembly number  
and follow the instructions.

# SEVEN

ALLUMINIO

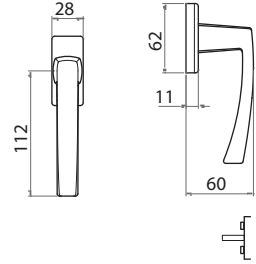

Mont. n°10

	F1	F3	F4	F9	Conf. Pz.
DK X 33 C/BUSS D.9,5 SEVEN DKX33 8SC RETT C/BUSS D.9,5 window handle DK x 33mm with pins D.9,5	7747055630158	7747055630358	7747055630458	7747055630958	100
DK X 35 C/BUSS D.9,5 SEVEN DKX35 8SC RETT C/BUSS D.9,5 window handle DK x 35mm with pins D.9,5	7747055650158	7747055650358	7747055650458	7747055650958	100
DK X 40 C/BUSS D.9,5 SEVEN DKX40 8SC RETT C/BUSS D.9,5 window handle DK x 40mm with pins D.9,5	7747055600158	7747055600358	7747055600458	7747055600958	100
DK X 45 C/BUSS D.9,5 SEVEN DKX45 8SC RETT C/BUSS D.9,5 window handle DK x 45mm with pins D.9,5	7747055640158	7747055640358	7747055640458	7747055640958	100



Per istruzioni di montaggio  
scansiona QR code,  
seleziona il numero di  
riferimento e segui le  
istruzioni.  
For assembly instructions  
scan the QR code, select the  
relevant assembly number  
and follow the instructions.

# SEVEN Q

ALLUMINIO

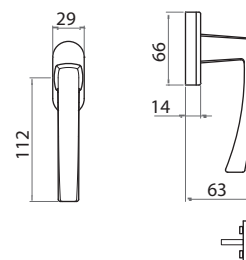

Mont. n°12

	F1	F3	F4	F9	Conf. Pz.
DK X 33 C/BUSS D.9,5 SEVEN DKX33 8SC RETT C/BUSS D.9,5 window handle DK x 33mm with pins D.9,5	7747055630158	7747055630358	7747055630458	7747055630958	100
DK X 35 C/BUSS D.9,5 SEVEN DKX35 8SC RETT C/BUSS D.9,5 window handle DK x 35mm with pins D.9,5	7747055650158	7747055650358	7747055650458	7747055650958	100
DK X 40 C/BUSS D.9,5 SEVEN DKX40 8SC RETT C/BUSS D.9,5 window handle DK x 40mm with pins D.9,5	7747055600158	7747055600358	7747055600458	7747055600958	100
DK X 45 C/BUSS D.9,5 SEVEN DKX45 8SC RETT C/BUSS D.9,5 window handle DK x 45mm with pins D.9,5	7747055640158	7747055640358	7747055640458	7747055640958	100



Per istruzioni di montaggio  
scansiona QR code,  
seleziona il numero di  
riferimento e segui le  
istruzioni.  
For assembly instructions  
scan the QR code, select the  
relevant assembly number  
and follow the instructions.



# SHARK

ALLUMINIO

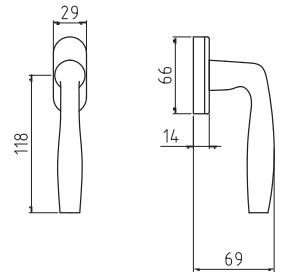

1

Mont. n°12

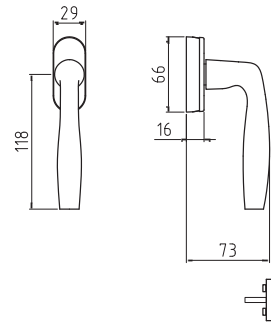

2

Mont. n°13

	F1	F3	F4	F9	Conf. Pz.
1 DKx33 8SC BUS. 9,5 SHARK DKx33 8SC BUS. 9,5 window handle DK x 33mm with pins D.9,5	7708055830158	7708055830358	7708055830458	7708055830958	100
1 DKx35 8SC BUS. 9,5 SHARK DKx35 8SC BUS. 9,5 window handle DK x 35mm with pins D.9,5	7708055850158	7708055850358	7708055850458	7708055850958	100
1 DKx40 8SC BUS. 9,5 SHARK DKx40 8SC BUS. 9,5 window handle DK x 40mm with pins D.9,5	7708055800158	7708055800358	7708055800458	7708055800958	100
1 DKx45 8SC BUS. 9,5 SHARK DKx45 8SC BUS. 9,5 window handle DK x 45mm with pins D.9,5	7708055840158	7708055840358	7708055840458	7708055840958	100
2 DK X 40-35 GHTECH SHARK GHTEK DK40-35 window handle DK x 40mm GHTECH	77080574001	77080574003	77080574004	77080574009	20
2 DK X 40-35 BUS. 9,5 GHTECH SHARK GHTEK DK40-35 BUS. 9,5 window handle DK x 40 mm with pins D.9,5 GHTECH	77080584001	77080584003	77080584004	77080584009	20



Per istruzioni di montaggio  
scansiona QR code,  
seleziona il numero di  
riferimento e segui le  
istruzioni.  
For assembly instructions  
scan the QR code, select the  
relevant assembly number  
and follow the instructions.

# UNIVERSAL

ALLUMINIO

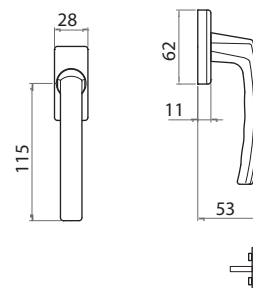

Mont. n°10

	F1	F3	F4	F9	Conf. Pz.
3 DKx33 8SC BUS. 9,5 UNIVERSAL DKx33 8SC BUS. 9,5 window handle DK x 33mm with pins D.9,5	7748655830158	7748655830358	7748655830458	7748655830958	100
3 DKx35 8SC BUS. 9,5 UNIVERSAL DKx35 8SC BUS. 9,5 window handle DK x 35mm with pins D.9,5	7748655850158	7748655850358	7748655850458	7748655850958	100
3 DKx40 8SC BUS. 9,5 UNIVERSAL DKx40 8SC BUS. 9,5 window handle DK x 40mm with pins D.9,5	7748655800158	7748655800358	7748655800458	7748655800958	100
3 DKx45 8SC BUS. 9,5 UNIVERSAL DKx45 8SC BUS. 9,5 window handle DK x 45mm with pins D.9,5	7748655840158	7748655840358	7748655840458	7748655840958	100



Per istruzioni di montaggio  
scansiona QR code,  
seleziona il numero di  
riferimento e segui le  
istruzioni.  
For assembly instructions  
scan the QR code, select the  
relevant assembly number  
and follow the instructions.

# 4038

ALLUMINIO

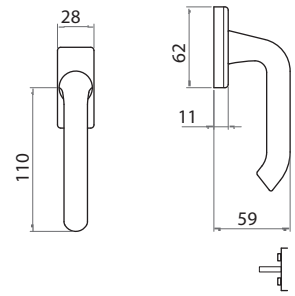

Mont. n°10

	F1	F3	F4	Conf. Pz.
DKx33 8SC BUS. 9,5 4038 DKx33 8SC BUS. 9,5 window handle DK x 33mm with pins D.9,5	7403855830158	7403855830358	7403855830458	100
DKx35 8SC BUS. 9,5 4038 DKx35 8SC BUS. 9,5 window handle DK x 35mm with pins D.9,5	7403855850158	7403855850358	7403855850458	100
DKx40 8SC BUS. 9,5 4038 DKx40 8SC BUS. 9,5 window handle DK x 40mm with pins D.9,5	7403855800158	7403855800358	7403855800458	100
DKx45 8SC BUS. 9,5 4038 DKx45 8SC BUS. 9,5 window handle DK x 45mm with pins D.9,5	7403855840158	7403855840358	7403855840458	100



Per istruzioni di montaggio  
scansiona QR code,  
seleziona il numero di  
riferimento e segui le  
istruzioni.  
For assembly instructions  
scan the QR code, select the  
relevant assembly number  
and follow the instructions.

# UNIVERSALE

ALLUMINIO

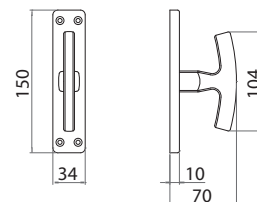

Mont. n°145

	F1	F3	F4	Conf. Pz.
CREM/MART SG CREM-MART SG UNIV Alox Window handle without mechanism	77442400001	77442400003	77442400004	10
MART MART UNIV ALOX window handle	77442500001	77442500003	77442500004	10



	ZB	Conf. Pz.
1 GIOCO EZ GIOCO EZ (062) Window mechanism	13340605070	10
2 GIOCO EZQ7 GIOCO EZ+Q7 Window mechanism	13340705070	10
3 GIOCO GRAZ GIOCO GRAZ FORI Window mechanism	13340305070	10
4 GIOCO GRAZ PERNI GIOCO GRAZ PERNI Window mechanism	13340205070	10
5 GIOCO GRAZ Q7 GIOCO GRAZ FORI+Q7 Window mechanism	13340315070	10



Per istruzioni di montaggio scansiona QR code, seleziona il numero di riferimento e segui le istruzioni.  
For assembly instructions scan the QR code, select the relevant assembly number and follow the instructions.

# 2010

ALLUMINIO

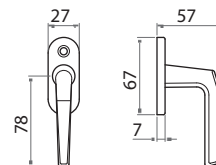

	F1	F3	F4	F9	Conf. Pz.
MART Q7 IM ROV 2010 MART Q7 ROV *	72010521001	72010521003	72010521004	72010521009	20
lever window handle on oval rose					

# 3013

ALLUMINIO

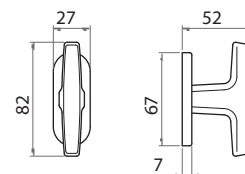

	F1	F3	F4	F9	Conf. Pz.
MART Q7 ROV 3013 MART Q7 ROV *	73013521001	73013521003	73013521004	73013521009	20
window handle					

# 6008

ALLUMINIO

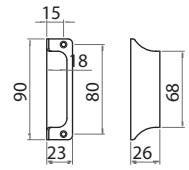

	F1	F3	F4	Conf. Pz.
MANIGLIETTA 6008 MANIGLIETTA Small handle	76008612001	76008612003	76008612004	20

# 6010

ALLUMINIO

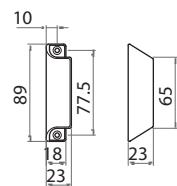

	F1	F3	F4	Conf. Pz.
MANIGLIETTA 6010 MANIGLIETTA Small handle	76010612001	76010612003	76010612004	20

# 7900 BALCONY

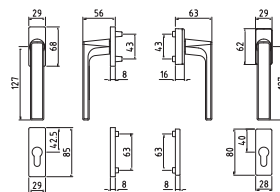

1 Mont. n°165

	F1	F3	F4	F9	Conf. Pz.
1 BALCONY DOOR G.ra ros bocc yale per porta balcone Q7 - viti pass Lever handle 7mm on rect rose key hole esc metrich-thread screw	77900217301	77900217303	77900217304	77900217309	
	RAL9010	GCTOL	ANO	F1-SAT	Conf. Pz.
1 BALCONY DOOR G.ra ros bocc yale per porta balcone Q7 - viti pass Lever handle 7mm on rect rose key hole esc metrich-thread screw	77900217307	77900217312	77900217316	77900217333	

# BRIXIA BALCONY

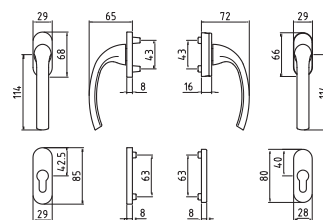

1 Mont. n°166

	F1	F3	F4	F9	Conf. Pz.
1 BALCONY DOOR G.ra ros bocc yale per porta balcone Q7 - viti pass Lever handle 7mm on rect rose key hole esc metrich-thread screw	77438227301	77438227303	77438227304	77438227309	
	RAL9010	RAL1013	ANO	RAL9016	Conf. Pz.
1 BALCONY DOOR G.ra ros bocc yale per porta balcone Q7 - viti pass Lever handle 7mm on rect rose key hole esc metrich-thread screw	77438227307	77438227310	77438227316	77438227380	



Per istruzioni di montaggio scansiona QR code, seleziona il numero di riferimento e segui le istruzioni.  
For assembly instructions scan the QR code, select the relevant assembly number and follow the instructions.

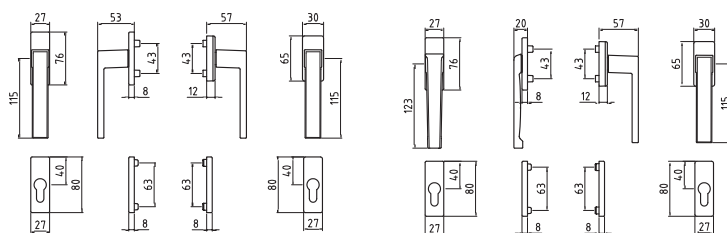

1 Mont. n°165

2 Mont. n°165

	F1	F4	F9	F3	Conf. Pz.
1 BALCONY DOOR G.ra ros bocc yale per porta balcone Q7 - viti pass Lever handle 7mm on rect rose key hole esc metrich-thread screw	77502217301	77502217304	77502217309		
2 BALCONY DOOR G.ra ros bocc yale per porta balcone Q7 - est rib viti pass Lever handle 7mm on rect rose key hole esc metrich-thread screw	77502217501	77502217504	77502217509		
	RAL9010	RAL1013	ANO	RAL9016	Conf. Pz.
1 BALCONY DOOR G.ra ros bocc yale per porta balcone Q7 - viti pass Lever handle 7mm on rect rose key hole esc metrich-thread screw	77502217307	77502217310	77502217316	77502217380	
2 BALCONY DOOR G.ra ros bocc yale per porta balcone Q7 - est rib viti pass Lever handle 7mm on rect rose key hole esc metrich-thread screw	77502217507	77502217510	77502217516	77502217580	

# ITACA BALCONY

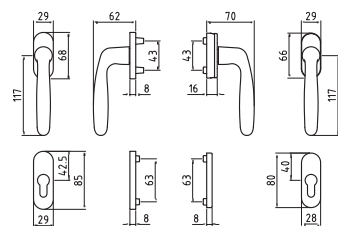

1 Mont. n°166

	F1	F4	F9	ANO	RAL9016	Conf. Pz.
1 BALCONY DOOR G.ra ros bocc yale per porta balcone Q7 - viti pass Lever handle 7mm on rect rose key hole esc metrich-thread screw	72005227301	72005227304	72005227309	72005227316	72005227380	



Per istruzioni di montaggio scansiona QR code, seleziona il numero di riferimento e segui le istruzioni.  
For assembly instructions scan the QR code, select the relevant assembly number and follow the instructions.



## 7900

ALLUMINIO GALATTICO

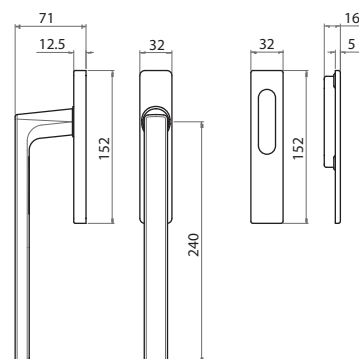

	MERCURY	URANUS	JUPITER	SPACE	Conf. Pz.
SCATTO MAN PC CONCH. Maniglione a scatto placca chiusa con conchiglia Pull handle for sliding door - closed plate	77900601033	77900601034	77900601041	77900601076	1
	⚡	⚡	⚡	⚡	

⚡ Servizio G48: Articolo a magazzino e disponibile entro 48 dall'elaborazione dell'ordine. In base a disponibilita' e condizioni di vendita.  
G48 service: Item in stock and available within 48 hours of order processing. Based on availability and sales conditions.

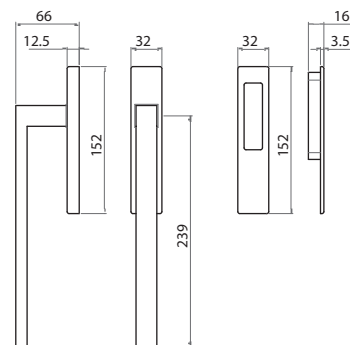

	ZCL	ZCS	ZNO	RAL9010	Conf. Pz.
SCATTO MAN PC CONCH. Maniglione a scatto placca chiusa con conchiglia <i>Pull handle for sliding door - closed plate</i>	66460601007	66460601013	66460601016	66460601063	1
SCATTO MAN PC PY Maniglione a scatto placca yale <i>Pull handle for sliding door w/cyl. Hole</i>	66460601507	66460601513	66460601516	66460601563	1
SCATTO MANCP Q 10 PC Coppia maniglioni a scatto Q10 placca chiusa <i>Pair pull handle with 10mm spindle + blind plate</i>	66460620007	66460620013	66460620016	66460620063	1
SCATTO MANCP Q 10 PY Coppia maniglioni a scatto Q10 placca yale <i>Pair pull handle with 10mm spindle + cyl. plate</i>	66460620507	66460620513	66460620516	66460620563	1
CONCH MAN SCATTO Conchiglia per maniglione a scatto <i>handle for sliding door</i>	66460680907	66460680913	66460680916	66460680963	1

⚡ Servizio G48: Articolo a magazzino e disponibile entro 48 dall'elaborazione dell'ordine. In base a disponibilita' e condizioni di vendita.  
G48 service: Item in stock and available within 48 hours of order processing. Based on availability and sales conditions.

# SHARK

OTTONE

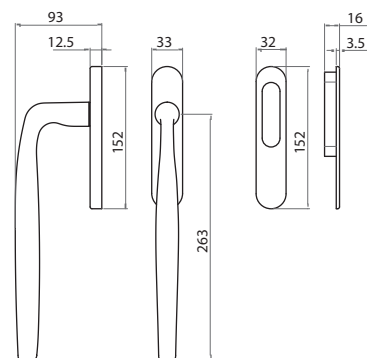

	OLV	OCS	OCL	Conf. Pz.
SCATTO MAN PC CONCH. Maniglione a scatto placca chiusa con conchiglia Pull handle for sliding door - closed plate	55480601001	55480601003	55480601007	1
SCATTO MAN PC PY Maniglione a scatto placca yale Pull handle for sliding door w/cyl. Hole	55480601501	55480601503	55480601507	1
SCATTO MANCP Q 10 PC Coppia maniglioni a scatto Q10 placca chiusa Pair pull handle with 10mm spindle + blind plate	55480620001	55480620003	55480620007	1
SCATTO MANCP Q 10 PY Coppia maniglioni a scatto Q10 placca yale Pair pull handle with 10mm spindle + cyl. plate	55480620501	55480620503	55480620507	1

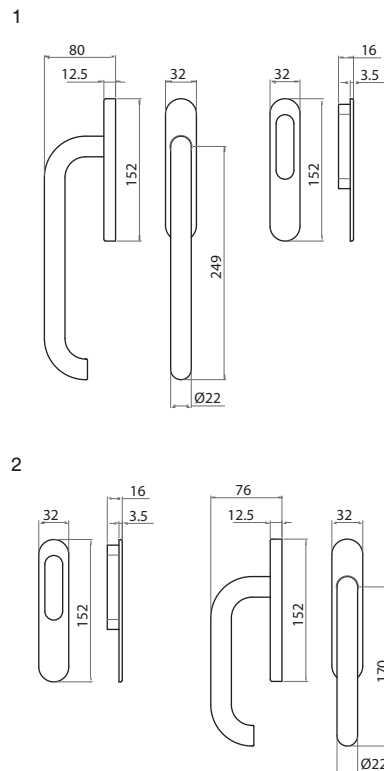

	OLV	OCS	OGV	OCL	OS	Conf. Pz.
1 SCATTO MAN PC CONCH. Maniglione a scatto placca chiusa con conchiglia Pull handle for sliding door - closed plate	55980601001	55980601003	55980601004	55980601007	55980601008	1
1 SCATTO MAN PC PY Maniglione a scatto placca yale Pull handle for sliding door w/cyl. Hole	55980601501	55980601503	55980601504	55980601507	55980601508	1
1 SCATTO MANCP Q 10 PC Coppia maniglioni a scatto Q10 placca chiusa Pair pull handle with 10mm spindle + blind plate	55980620001	55980620003	55980620004	55980620007	55980620008	1
1 SCATTO MANCP Q 10 PY Coppia maniglioni a scatto Q10 placca yale Pair pull handle with 10mm spindle + cyl. plate	55980620501	55980620503	55980620504	55980620507	55980620508	1
1 SCATTO MI MAN PC CONCH. Maniglione a scatto mignon placca chiusa con conchiglia Pull handle for sliding doors with sliding handle	55980605001	55980605003	55980605004	55980605007	55980605008	1
2 SCATTO MI MAN PC PY Maniglione a scatto mignon placca yale Pull handle for sliding door	55980605501	55980605503	55980605504	55980605507	55980605508	1
2 CONCH MAN SCATTO Conchiglia per maniglione a scatto handle for sliding door	55980680901	55980680903	55980680904	55980680907	55980680908	4

# EUROPA

ALLUMINIO

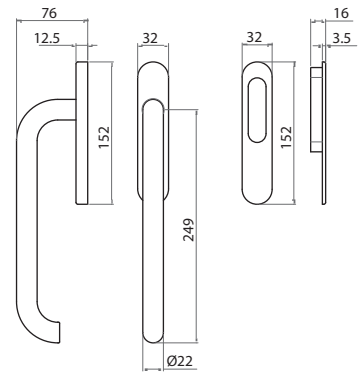

	F1	F4	GCTOL	F1-SAT	Conf. Pz.
SCATTO MAN PC CONCH. Maniglione a scatto placca chiusa con conchiglia Pull handle for sliding door - closed plate	77980601001	77980601004	77980601012	77980601033	1
SCATTO MAN PC PY Maniglione a scatto placca yale Pull handle for sliding door w/cyl. Hole	77980601501	77980601504	77980601512	77980601533	1
SCATTO MANCP Q 10 PC Coppia maniglioni a scatto Q10 placca chiusa Pair pull handle with 10mm spindle + blind plate	77980620001	77980620004	77980620012	77980620033	1
SCATTO MANCP Q 10 PY Coppia maniglioni a scatto Q10 placca yale Pair pull handle with 10mm spindle + cyl. plate	77980620501	77980620504	77980620512	77980620533	1
CONCH MAN SCATTO Conchiglia per maniglione a scatto handle for sliding door	77980680901	77980680904	77980680912	77980680933	1
CONCH MAN SCATTO Conchiglia per maniglione a scatto handle for sliding door	77980680901	77980680904	77980680912	77980680933	1

# 7900

ALLUMINIO

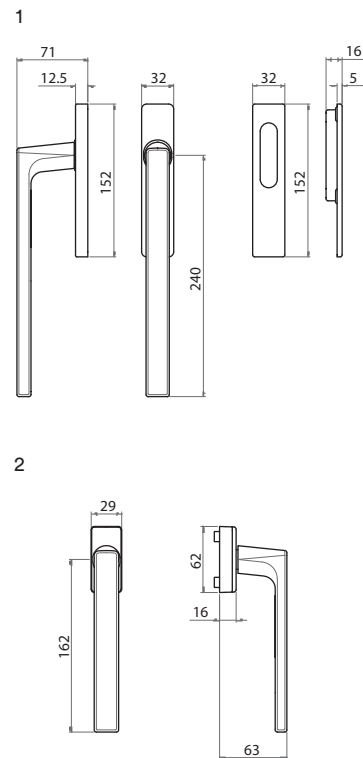

	F1	F3	F4	F9	Conf. Pz.
1 SCATTO MAN PC CONCH. Maniglione a scatto placca chiusa con conchiglia <i>Pull handle for sliding door - closed plate</i>	77900601001	77900601003	77900601004	77900601009	1
1 SCATTO MAN PC PY Maniglione a scatto placca yale <i>Pull handle for sliding door w/cyl. Hole</i>	77900601501	77900601503	77900601504	77900601509	1
1 SCATTO MANCP Q 10 PC Coppia maniglioni a scatto Q10 placca chiusa <i>Pair pull handle with 10mm spindle + blind plate</i>	77900620001	77900620003	77900620004	77900620009	1
1 SCATTO MANCP Q 10 PY Coppia maniglioni a scatto Q10 placca yale <i>Pair pull handle with 10mm spindle + cyl. Plate</i>	77900620501	77900620503	77900620504	77900620509	1
2 COMPLANARE DKX40 C/BUS Maniglione dk per complanare <i>window handle with 7mm spindle for sliding door</i>	77900554201	77900554203	77900554204	77900554209	1

					Conf. Pz.
1 SCATTO MAN PC CONCH. Maniglione a scatto placca chiusa con conchiglia <i>Pull handle for sliding door - closed plate</i>	77900601007	77900601012	77900601016	77900601033	1
1 SCATTO MAN PC PY Maniglione a scatto placca yale <i>Pull handle for sliding door w/cyl. Hole</i>	77900601507	77900601512	77900601516	77900601533	1
1 SCATTO MANCP Q 10 PC Coppia maniglioni a scatto Q10 placca chiusa <i>Pair pull handle with 10mm spindle + blind plate</i>	77900620007	77900620012	77900620016	77900620033	1
1 SCATTO MANCP Q 10 PY Coppia maniglioni a scatto Q10 placca yale <i>Pair pull handle with 10mm spindle + cyl. plate</i>	77900620507	77900620512	77900620516	77900620533	1
2 COMPLANARE DKX40 C/BUS Maniglione dk per complanare <i>window handle with 7mm spindle for sliding door</i>	77900554207	77900554212	77900554216	77900554233	1

⚡ Servizio G48: Articolo a magazzino e disponibile entro 48 dall'elaborazione dell'ordine. In base a disponibilità e condizioni di vendita.  
G48 service: Item in stock and available within 48 hours of order processing. Based on availability and sales conditions.

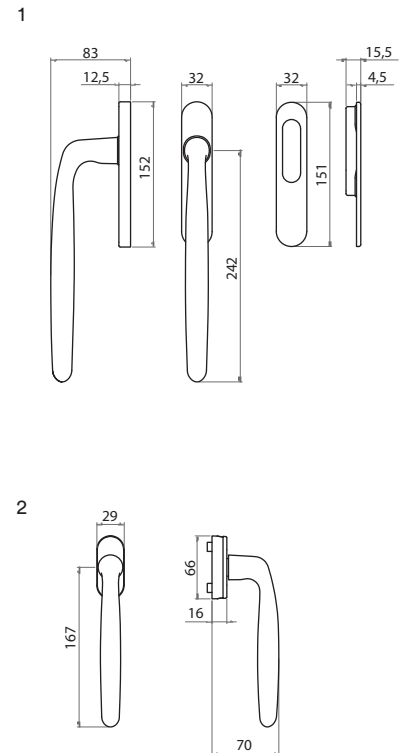

	F1	F3	F4	F9	Conf. Pz.
1 SCATTO MAN PC CONCH. Maniglione a scatto placca chiusa con conchiglia Pull handle for sliding door - closed plate	72005601001	72005601003	72005601004	72005601009	1
1 SCATTO MAN PC PY Maniglione a scatto placca yale Pull handle for sliding door w/cyl. Hole	72005601501	72005601503	72005601504	72005601509	1
1 SCATTO MANCP Q 10 PC Coppia maniglioni a scatto Q10 placca chiusa Pair pull handle with 10mm spindle + blind plate	72005620001	72005620003	72005620004	72005620009	1
1 SCATTO MANCP Q 10 PY Coppia maniglioni a scatto Q10 placca yale Pair pull handle with 10mm spindle + cyl. Plate	77905620501	77905620503	77905620504	77905620509	1
2 COMPLANARE DKX40 C/BUS Maniglione dk per complanare window handle with 7mm spindle for sliding door	72005552201	72005552203	72005552204	72005552209	1

	RAL9010	GCTOL	ANO	F1-SAT	Conf. Pz.
1 SCATTO MAN PC CONCH. Maniglione a scatto placca chiusa con conchiglia Pull handle for sliding door - closed plate	72005601007	72005601012	72005601016	72005601033	1
1 SCATTO MAN PC PY Maniglione a scatto placca yale Pull handle for sliding door w/cyl. Hole	72005601507	72005601512	72005601516	72005601533	1
1 SCATTO MANCP Q 10 PC Coppia maniglioni a scatto Q10 placca chiusa Pair pull handle with 10mm spindle + blind plate	72005620007	72005620012	72005620016	72005620033	1
1 SCATTO MANCP Q 10 PY Coppia maniglioni a scatto Q10 placca yale Pair pull handle with 10mm spindle + cyl. plate	77905620507	77905620512	77905620516	77905620533	1
2 COMPLANARE DKX40 C/BUS Maniglione dk per complanare window handle with 7mm spindle for sliding door	72005552207	72005552212	72005552216	77900552233	1





# 3

**Accessori per  
porte e finestre**

**Accessories for  
doors and windows**

- 318 Rosette Ottone / Brass roses
- 326 Nottolini Ottone / Brass knobs
- 329 Rosette e placche Alluminio / Aluminum roses and plates
- 342 Giochi DK / DK mechanism
- 343 Ferri / Spindles
- 346 Viti / Screws

# ROS 45X9

OTTONE

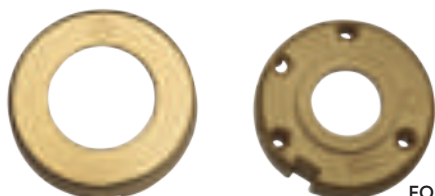

FORO/HOLE Ø16MM

- SUPPORTO IN POLIMERO
- MOLLA TRADIZIONALE DX O SX
- MANIGLIA SOLIDALE
- NON PREDISPOSTA PER VITI PASSANTI

- PLASTIC SUPPORT
- STANDARD SPRING LH/RH
- HANDLE FIXED ON THE ROSE
- NOT AVAILABLE FOR THROUGH BOLTS

	OLV	OCS	OGV	OCL	OS	Conf. Pz.
ROS TONDA COP MILENA ROS TONDA COP Rund rose	55748531001	55748531003	55748531004	55748531007	55748531008	10
BOC PAT MILENA BOC TONDA PAT Round key escutcheon	55748631001	55748631003	55748631004	55748631007	55748631008	10
BOC YALE MILENA BOC TONDA YAL Round cyl. Escutcheon	55748635001	55748635003	55748635004	55748635007	55748635008	10

# ROS 45X9 NOVECENTO

OTTONE



FORO/HOLE Ø16MM

- SUPPORTO IN POLIMERO
- MOLLA TRADIZIONALE DX O SX
- MANIGLIA SOLIDALE
- NON PREDISPOSTA PER VITI PASSANTI

- PLASTIC SUPPORT
- STANDARD SPRING LH/RH
- HANDLE FIXED ON THE ROSE
- NOT AVAILABLE FOR THROUGH BOLTS

	OBR	OLV	OCL	OLD	OFA	Conf. Pz.
ROS 45x9 C/RIGA NOVECENTO ROS 45X9 FD22 C/RIGA Rund rose with line	55198531000	55198531001	55198531007	55198531028	55198531029	10
BOC PAT NOVECENTO BOC 45X9 PAT C/RIGA Round key escutcheon	55198631000	55198631001	55198631007	55198631028	55198631029	10
BOC YALE NOVECENTO BOC 45X9 YALE C/RIGA Round cyl. Escutcheon	55198635000	55198635001	55198635007	55198635028	55198635029	10

# ROS 545

OTTONE

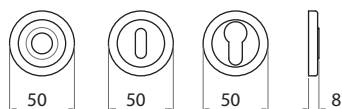

FORO/HOLE Ø16MM

- SUPPORTO IN POLIMERO
- MOLLA TRADIZIONALE DX O SX
- MANIGLIA SOLIDALE
- PREDISPOSTA PER VITI PASSANTI INTER. MM 38 AUTOFILETTANTI O METRICHE

- PLASTIC SUPPORT
- STANDARD SPRING LH/RH
- HANDLE FIXED ON THE ROSE
- AVAILABLE FOR THROUGH BOLTS - SELF DRILLING SCREW/METRIC SCREWS

	OLS	ONL/ONS	OCL/OCS	Conf. Pz.
ROS 545 SINGOLA ROS.F16 COLLO 24 Rund rose	R054553106502	R054553106557	R054553106559	10
BOC PAT 545 SINGOLA BOC.PAT Round key escutcheon	R054563106502	R054563106557	R054563106559	10
BOC YALE 545 SINGOLA BOC.PZ Round cyl. Escutcheon	R054563506502	R054563506557	R054563506559	10

# ROS 50x7-0005

OTTONE

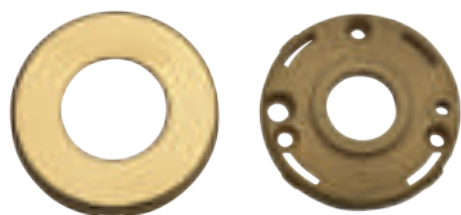

FORO/HOLE Ø16-18MM

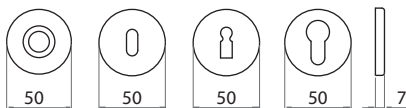

- SUPPORTO IN POLIMERO
- MOLLA TRADIZIONALE DX O SX
- MANIGLIA SOLIDALE
- PREDISPOSTA PER VITI PASSANTI INT. MM 38 AUTOFIETTANTI O METRICHE
- PLASTIC SUPPORT
- STANDARD SPRING LH/RH
- HANDLE FIXED ON THE ROSE
- AVAILABLE FOR THROUGH BOLTS - SELF DRILLING SCREW/METRIC SCREWS

## SISTEMI DI MONTAGGIO DISPONIBILI

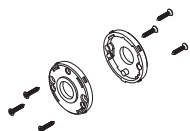

VL: VITI LEGNO  
VL: WOOD SCREWS

RIF. CATALOGO



VPA: VITI PASSANTI AUTOFILETTANTI  
VPA: THROUGH BOLTS SELF-DRILLING SCREWS

DISPONIBILE SU RICHIESTA

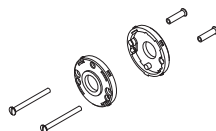

VPM: VITI PASSANTI METRICHE  
VPM: THROUGH BOLTS METRIC SCREWS

DISPONIBILE SU RICHIESTA

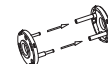

ATTACCO RAPIDO  
FAST CONNECTION

DISPONIBILE SU RICHIESTA

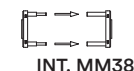

	OLV	OCS	OGV	OCL	OS	Conf. Pz.
ROS TONDA COP 50 ROS.50x7 COPRIVITE	55748531301	55748531303	55748531304	55748531307	55748531308	10
Rund rose						
BOC PAT BOC.50x7 SINGOLA PAT	55748631301	55748631303	55748631304	55748631307	55748631308	10
Round key escutcheon						
BOC BB BOC.50x7 SINGOLA BB	55748631201	55748631203	55748631204	55748631207	55748631208	10
Escutcheon BB key hole						
BOC YALE BOC.50x7 SINGOLA YALE	55748635301	55748635303	55748635304	55748635307	55748635308	10
Round cyl. Escutcheon						

	ONS	OLD	OFA	ONL	OANT	Conf. Pz.
ROS TONDA COP 50 ROS.50x7 COPRIVITE	55748531327	55748531328	55748531329	55748531330	55748531342	10
Rund rose						
BOC PAT BOC.50x7 SINGOLA PAT	55748631327	55748631328	55748631329	55748631330	55748631342	10
Round key escutcheon						
BOC BB BOC.50x7 SINGOLA BB	55748631227	55748631228	55748631229	55748631230	55748631242	10
Escutcheon BB key hole						
BOC YALE BOC.50x7 SINGOLA YALE	55748635327	55748635328	55748635329	55748635330	55748635342	10
Round cyl. Escutcheon						

# ROS 52x10-575

OTTONE

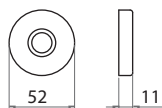
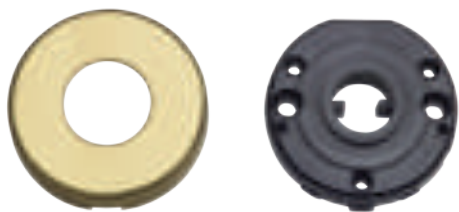

- SUPPORTO IN POLIMERO CON MOLLA  
AMBIDESTRA INSERITA
- MANIGLIA STACCATA
- PREDISPOSTA PER VITI PASSANTI INT. MM  
38 AUTOFILETTANTI O METRICHE

- PLASTIC SUPPORT WITH SPRING LOADED LH/RH
- DETACHED HANDLE
- AVAILABLE FOR THROUGH BOLTS - SELF DRILLING  
SCREW/METRIC SCREWS

	ONS	OLD	OFA	ONL	OANT	Conf. Pz.
ROS TONDA COP 50 ROS.50x7 COPRIVITE Round rose	55748531327	55748531328	55748531329	55748531330	55748531342	10
BOC PAT BOC.50x7 SINGOLA PAT Round key escutcheon	55748631327	55748631328	55748631329	55748631330	55748631342	10
BOC BB BOC.50x7 SINGOLA BB Escutcheon BB key hole	55748631227	55748631228	55748631229	55748631230	55748631242	10

# ROS GOLF

OTTONE

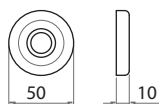

- SUPPORTO IN OTTONE
- MOLLA TRADIZIONALE DX O SX
- MANIGLIA SOLIDALE
- NON PREDISPOSTA PER VITI PASSANTI

- BRASS SUPPORT
- STANDARD SPRING LH/RH
- HANDLE FIXED ON THE ROSE
- NOT AVAILABLE FOR THROUGH BOLTS

	OLV	OCS	OCL	Conf. Pz.
ROS GOLF ROS Round rose	55148531001	55148531003	55148531007	10
BOC PAT GOLF BOC PAT Round key escutcheon	55148631001	55148631003	55148631007	10
BOC YALE GOLF BOC YALE Round cyl. Escutcheon	55148635001	55148635003	55148635007	10

# ROS 61

OTTONE

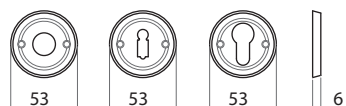

- MONOBLOCCO
- NON PREDISPOSTA PER MOLLA
- MANIGLIA STACCATA
- PREDISPOSTA PER VITI PASSANTI INT. MM  
38 METRICHE

- SOLID ROSE
- NOT AVAILABLE FOR SPRING
- DETACHED HANDLE
- AVAILABLE FOR THROUGH BOLTS METRIC  
SCREWS

	OLV	Conf. Pz.
ROS 61 ROSETTA OT F.20 C/FV Round rose	R00610000001	10
BOC BB 61 SINGOLA BOC.BB VV Escutcheon BB key hole	R006264126501	10
BOC PZ 61 SINGOLA BOC.PZ VV Round cyl. Escutcheon	R006264506501	10

# ROS 45x10 V.V.

OTTONE

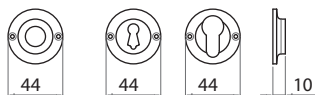

- MONOBLOCCO
- NON PREDISPOSTA PER MOLLA
- MANIGLIA SOLIDALE
- NON PREDISPOSTA PER VITI PASSANTI
- SOLID ROSE
- NOT AVAILABLE FOR SPRING
- FIXED HANDLE
- NOT AVAILABLE FOR THROUGH BOLTS

	OBR	OLV	OCL	OLD	OFA	Conf. Pz.
ROS ROS.900 MM.45 V.V. Round rose	55198541000	55198541001	55198541007	55198541028	55198541029	10
BOC PAT BOC.900 MM45 V.V. PATENT Round key escutcheon	55198641000	55198641001	55198641007	55198641028	55198641029	10
BOC YALE BOC.900 MM45 V.V. YALE Round cyl. Escutcheon	55198645000	55198645001	55198645007	55198645028	55198645029	10

# ROS 45x45x10

OTTONE

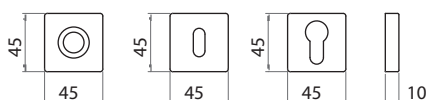

- SUPPORTO IN POLIMERO
- MOLLA TRADIZIONALE DX O SX
- MANIGLIA SOLIDALE
- NON PREDISPOSTA PER VITI PASSANTI
- PLASTIC SUPPORT
- STANDARD SPRING LH/RH
- FIXED HANDLE
- AVAILABLE FOR THROUGH BOLTS

	OCS	OCL	Conf. Pz.
ROS ROS. Q45X45 QUADRA ASSEMB. F16 square rose	55448553003	55448553007	10
BOC PAT BOC.45X45 PAT square key escutcheon	55448653003	55448653007	10
BOC YALE BOC.45X45 YALE square cyl. Escutcheon	55448655503	55448655507	10

# ROS 50x50x10 - 574

OTTONE / ALLUMINIO

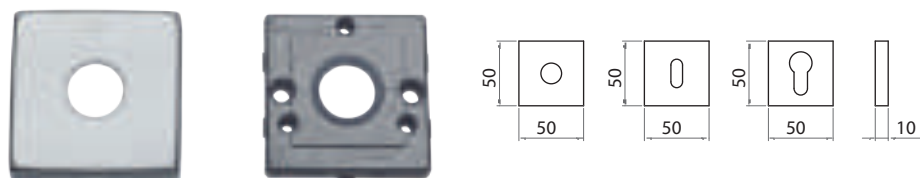

- SUPPORTO IN POLIMERO
- MOLLA TRADIZIONALE DX O SX
- MANIGLIA SOLIDALE
- PREDISPOSTA PER VITI PASSANTI INT. MM 38 AUTOFILETTANTI O METRICHE

- PLASTIC SUPPORT
- STANDARD SPRING LH/RH
- HANDLE FIXED ON THE ROSE
- AVAILABLE FOR THROUGH BOLTS - SELF DRILLING SCREW/METRIC SCREWS

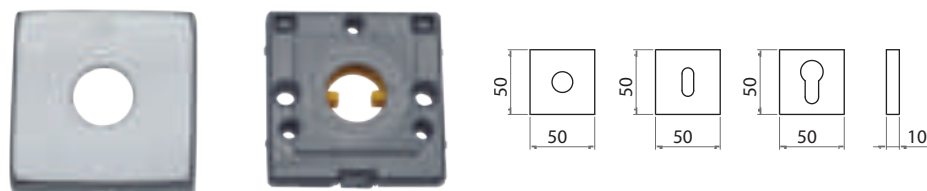

- SUPPORTO IN POLIMERO CON MOLLA AMBIDESTRA INSERITA
- MANIGLIA STACCATA
- PREDISPOSTA PER VITI PASSANTI INT. MM 38 AUTOFILETTANTI O METRICHE

- PLASTIC SUPPORT WITH SPRING LOADED LH/RH
- DETACHED HANDLE
- AVAILABLE FOR THROUGH BOLTS - SELF DRILLING SCREW/METRIC SCREWS

	OLV	OCS	OCL	ONS	Conf. Pz.
ROS ROS.50X50 QUADRA ASSEMBL. F16 collo 21 singola s/molla square rose	55448551201	55448551203	55448551207	55448551227	10
ROS ROS.50X50 QUADRA ASSEMBL. F16 collo 21 singola c/molla square rose	55448551001	55448551003	55448551007	55448551027	10
BOC PAT BOC.50X50 QUADRA ASSEMBL. PAT square key escutcheon	55448651001	55448651003	55448651007	55448651027	10
BOC YALE BOC.50X50 QUADRA ASSEMBL. YAL square cyl. Escutcheon	55448655001	55448655003	55448655007	55448655027	10

# ROS 544

OTTONE

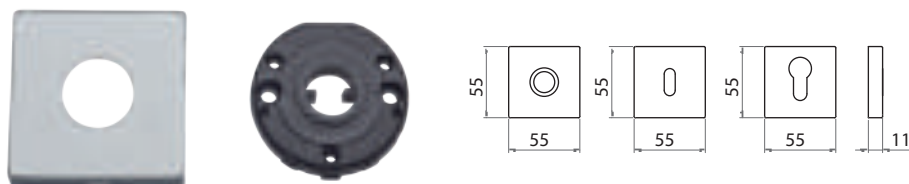

- SUPPORTO IN POLIMERO CON MOLLA AMBIDESTRA INSERITA
- MANIGLIA STACCATA
- PREDISPOSTA PER VITI PASSANTI INT. MM 38 AUTOFILETTANTI O METRICHE

- PLASTIC SUPPORT WITH SPRING LOADED LH/RH
- DETACHED HANDLE
- AVAILABLE FOR THROUGH BOLTS - SELF DRILLING SCREW/METRIC SCREWS

	ZCL	ZCS	ZNS	ZNL	Conf. Pz.
ROS ROS 544 ZAMA C/M DX/SX square rose	R054400006507	R054400006513	R054400006527	R054400006530	10
BOC BB 544 SINGOLA BOC.PAT RASATA Escutcheon BB key hole	R054465106507	R054465106513	R054465106527	R054465106530	10
BOC PZ 544 SINGOLA BOC.PZ RASATA Round cyl. Escutcheon	R054465506507	R054465506513	R054465506527	R054465506530	10

# ROS 30x30

OTTONE

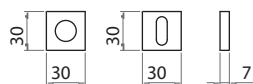

- SUPPORTO IN POLIMERO CON MOLLA
- AMBIDESTRA INSERITA
- MANIGLIA STACCATA
- NON PREDISPOSTA PER VITI PASSANTI
- PLASTIC SUPPORT WITH SPRING
- LOADED LH/RH
- DETACHED HANDLE
- NOT AVAILABLE FOR THROUGH BOLTS

	OCS	OCL	F1-SAT	Conf. Pz.
ROS				
ROS.30x30 QUADRA F.16 OT C/MOLLA	55448552803	55448552807	77498552833	10
square rose				
BOC PAT				
BOC.30X30 QUADRA ASSEMBL. PAT	55448652803	55448652807	77498652833	10

# ROS 30x30

OTTONE

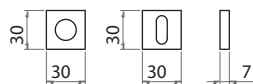

- SUPPORTO IN POLIMERO CON MOLLA
- AMBIDESTRA INSERITA
- MANIGLIA STACCATA
- NON PREDISPOSTA PER VITI PASSANTI
- PLASTIC SUPPORT WITH SPRING
- LOADED LH/RH
- DETACHED HANDLE
- NOT AVAILABLE FOR THROUGH BOLTS

	OCS	OCL	F1-SAT	Conf. Pz.
ROS				
ROS.30x30 QUADRA F.16 OT C/MOLLA	55448552803	55448552807	77498552833	10
square rose				
BOC PAT				
BOC.30X30 QUADRA ASSEMBL. PAT	55448652803	55448652807	77498652833	10



# ROS 30x60-0006

OTTONE



D. FORO 24MM



D. FORO 16MM

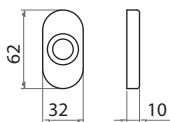

- SUPPORTO IN POLIMERO
- PREDISPOSTA PER MOLLA TRADIZIONALE DX O SX CON MANIGLIA SOLIDALE

- PLASTIC SUPPORT
- AVAILABLE FOR STANDARD SPRING LH/RH



D. FORO 16MM

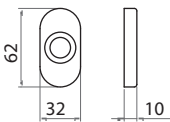

- SUPPORTO IN POLIMERO CON MOLLA AMBIDESTRA INSERITA
- MANIGLIA STACCATA

- PLASTIC SUPPORT WITH SPRING LOADED LH/RH
- DETACHED HANDLE

	OLV	OCS	OGV	OCL	OS	Conf. Pz.
ROS	55498521001	55498521003	55498521004	55498521007	55498521008	10
ROS OVALE COP.30X60 F24 c/inserto F16 oval rose						
ROS	55498521301	55498521303	55498521304	55498521307	55498521308	10
ROS OVALE COP.30X60 c/molla dx/sx oval rose						
BOC PAT	55498621001	55498621003	55498621004	55498621007	55498621008	10
BOC COP OVALE PAT oval key escutcheon						
BOC YALE	55498625001	55498625003	55498625004	55498625007	55498625008	10
BOC COP OVALE YAL oval cyl. Escutcheon						

# ROS 30x60-00C6



D. FORO 24MM



D. FORO 16MM

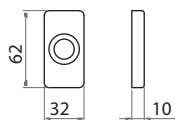

- SUPPORTO IN POLIMERO
- MANIGLIA STACCATA
- PREDISPOSTA PER MOLLA TRADIZIONALE DX O SX
- CON MANIGLIA SOLIDALE

- PLASTIC SUPPORT
- DETACHED HANDLE
- AVAILABLE FOR STANDARD SPRING LH/RH WITH FIXED HANDLE



D. FORO 16MM

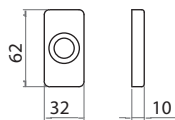

- SUPPORTO IN POLIMERO CON MOLLA AMBIDESTRA INSERITA
- MANIGLIA STACCATA

- PLASTIC SUPPORT WITH SPRING LOADED LH/RH
- DETACHED HANDLE

	OLV	OCS	OCL	Conf. Pz.
ROS	55448511501	55448511503	55448511507	10
ROS RETT. 30X60x9,5 FD24 s/molla Rectangular rose				
ROS	55448511601	55448511603	55448511607	10
ROS RETT. 30X60x9,5 FD16 c/molla Rectangular rose				
BOC PATENT	55448611501	55448611503	55448611507	10
BOC.30X60 RETT. ASSEMBL. PAT rectangular key escutcheon				
BOC YALE	55448615501	55448615503	55448615507	10
BOC.30X60 RETT. ASSEMBL. YALE rectangular cyl. Escutcheon				

# MILENA

OTTONE

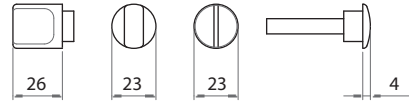

	OGV	OCL	OS	ONS	ONL	Conf. Pz.
NOTT WC Q6	55448229004	55448229007	55448229008	55448229027	55448229030	2
MILENA NOTT WC Q6						
Toilet set - spindle 6 mm without rose						

# MEZZALUNA

OTTONE

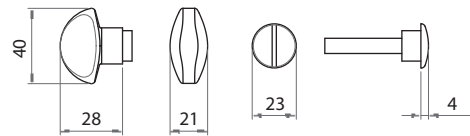

	ZCL	GCTOL	ZCS	ZNS-M9	ZNL-M7	Conf. Pz.
NOTT WC Q6	66748229007	66748229012	66748229013	66748229027	66748229030	2
MEZZALUNA+MILENA NOTT. WC Q6						
Toilet set - spindle 6 mm without rose						
NOTT WC Q8	66748229807	66748229812	66748229813	66748229827	66748229830	2
MEZZALUNA+MILENA NOTT. WC Q8						
Toilet set - spindle 8 mm without rose						

# GOLF

OTTONE

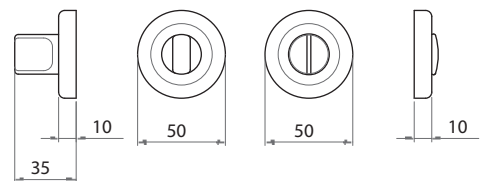

	OLV	OCS	OCL	Conf. Pz.
NOTT RWC	55148638001	55148638003	55148638007	2
GOLF NOTT RWC Q6				
Toilet set - spindle 8 mm without rose				

# MILENA

OTTONE

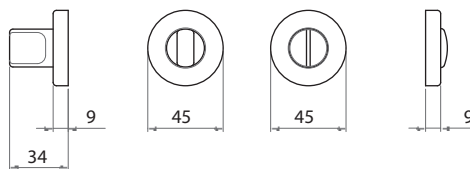

	OLV	OCS	OGV	OCL	OS	Conf. Pz.
NOTT RWC 45x9 MILENA NOTT RWC Toilet set Q 6 with rose	55448638001	55448638003	55448638004	55448638007	55448638008	2
NOTT RWC 50x7 MILENA NOTT RWC50x7 Q6 Toilet set Q 6 with rose	55448638301	55448638303	55448638304	55448638307	55448638308	2
NOTT RWC 50x10 MILENA NOTT RWC52x10 Toilet set Q 6 with rose	55448639801	55448639803	55448639804	55448639807	55448639808	2

# NOVECENTO

OTTONE

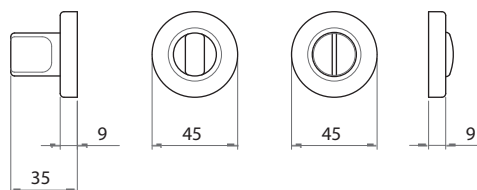
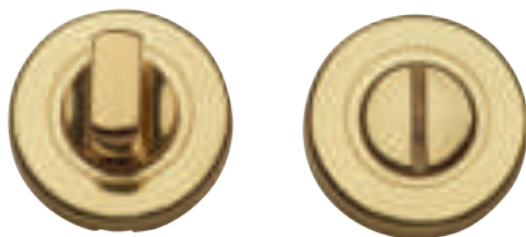

	OBR	OLV	OCL	OLD	OFA	Conf. Pz.
NOTT RWC NOVECENTO NOTT RWC Toilet set - spindle 6 mm with rose	55198638000	55198638001	55198638007	55198638028	55198638029	2

# MILENA

OTTONE

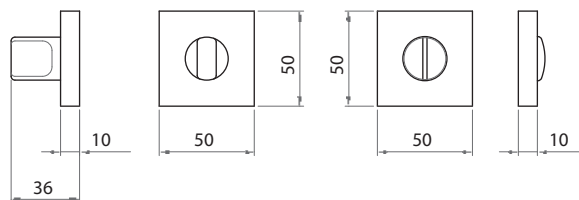

	OLV	OCS	OCL	ONS	Conf. Pz.
NOTT RWC MILENA ROS.50X50 QUADRA CON NOTTOLINO Toilet set Q 6 with rose	55448668001	55448668003	55448668007	55448668027	2

# FRAME

ALLUMINIO

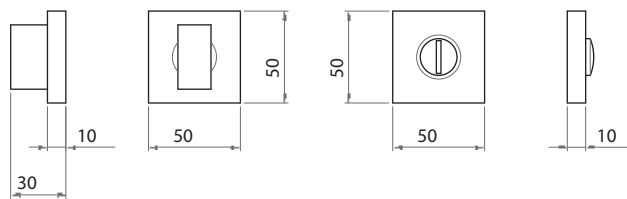

NOTT RWC  
 NOTT. FRAME ROS."Q" ASSEMBL.  
 Toilet set Q 6 with rose

ACL	F1-SAT	Conf. Pz.
77472658017	77472658033	2

# WING

OTTONE

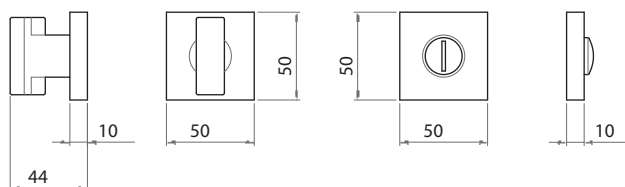

NOTT RWC  
 NOTT. WING RQWC  
 Toilet set Q 6 with rose

ZCL	ZCS	Conf. Pz.
66792658007	66792658013	2

# ROS 50x50

ALLUMINIO

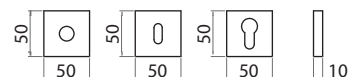

	F1	F3	F4	F9	F1-SAT	Conf. Pz.
COPPIA ROS.Q 50x50 F.18 Coppia rosette quadre 50x50 F.18 pair of square roses 50x50 18mm hole	77498554001	77498554003	77498554004	77498554009	77498554033	10
ROS ROS.50X50 QUADRA ASSEMBL. F16 singola c/molla square rose	77498551001	77498551003	77498551004	77498551009	77498551033	10
COPPIA BOC.Q 50x50 PAT Coppia bocchette quadre 50x50 patent Pair square escutcheons 50x50 key hole	77498651101	77498651103	77498651104	77498651109	77498651133	10
COPPIA BOC.Q 50x50 YALE Coppia bocchette quadre 50x50 Yale Pair square escutcheons 50x50 cyl. hole	77498655101	77498655103	77498655104	77498655109	77498655133	10

# ROS 45x7

ALLUMINIO



	F3	F4	F9	GCTOL	F1-SAT	Conf. Pz.
COPPIA ROS 45x7 F.18 Coppia rosette 45x7 F.18 pair of round roses 45x7 18mm hole	77448531003	77448531004	77448531009	77448531012	77448531033	10
COPPIA BOC 45x7 PAT Coppia bocchette 45x7 patent Pair escutcheons 45x7 key hole	77448631003	77448631004	77448631009	77448631012	77448631033	10
COPPIA BOC 45x7 YALE Coppia bocchette 45x7 Yale Pair escutcheons 45x7 key hole	77448635003	77448635004	77448635009	77448635012	77448635033	10

# ROS 45x7 VITI A VISTA

ALLUMINIO

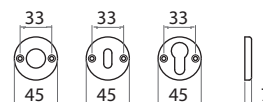

	F1	F3	F4	F9	Conf. Pz.
COPPIA ROS 45x7 F.20 V.V. Coppia rosette 45x7 F.20 viti vista pair of round roses 45x7 18mm hole	77448541001	77448541003	77448541004	77448541009	10
COPPIA BOC 45x7 PAT V.V. Coppia bocchette 45x7 patent viti vista Pair escutcheons 45x7 key hole	77448641001	77448641003	77448641004	77448641009	10
COPPIA BOC 45x7 YALE V.V. Coppia bocchette 45x7 Yale viti vista Pair escutcheons 45x7 cyl. hole	77448645001	77448645003	77448645004	77448645009	10

# ROS 50x7

ALLUMINIO

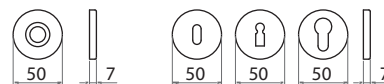

## SISTEMI DI MONTAGGIO DISPONIBILI

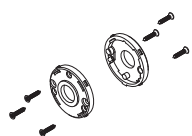

VL: VITI LEGNO  
VL: WOOD SCREWS

RIF. CATALOGO

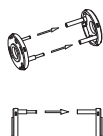

INT. MM38  
ATTACCO RAPIDO  
FAST CONNECTION

RIF. CATALOGO

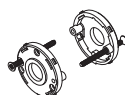

VPA: VITI PASSANTI AUTOFILETTANTI  
VPA: THROUGH BOLTS SELF-DRILLING  
SCREWS

DISPONIBILE SU RICHIESTA

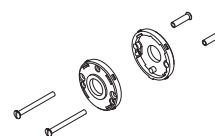

VPM: VITI PASSANTI METRICHE  
VPM: THROUGH BOLTS METRIC  
SCREWS

DISPONIBILE SU RICHIESTA

	F1	F3	F4	F9	GCTOL	F1-SAT	Conf. Pz.
COPPIA ROS. 50x7 F.18 Coppia rosette 50x7 F18 pair of round roses 50x7 18mm hole	77448531401	77448531403	77448531404	77448531409	77448531412	77448531433	10
COPPIA ROS. 50x7 F.18 Coppia rosette 50x7 F18 ATTACCO RAPIDO pair of round roses 50x7 18mm hole speed connection	77448531401AR	77448531403AR	77448531404AR	77448531409AR	77448531412AR	77448531433AR	10
COPPIA ROS. 50x7 F.16 Coppia rosette 50x7 F16 ATTACCO RAPIDO pair of round roses 50x7 16mm hole speed connection	77448532201AR	77448532203AR	77448532204AR	77448532209AR	77448532212AR	77448532233AR	10
COPPIA BOC 50x7 PAT Coppia bocchette 50x7 patent Pair escutcheons 50x7 key hole	77448631301	77448631303	77448631304	77448631309	77448631312	77448631333	10
COPPIA BOC 50x7 PAT Coppia bocchette 50x7 patent attacco rapido Pair escutcheons 50x7 key hole speed connection	77448631301AR	77448631303AR	77448631304AR	77448631309AR	77448631312AR	77448631333AR	10
COPPIA BOC 50x7 BB Coppia bocchette 50x7 BB Pair escutcheons 50x7 BB key hole	77448631701	77448631703	77448631704	77448631709	77448631712	77448631733	10
COPPIA BOC 50x7 YALE Coppia bocchette 50x7 Yale Pair escutcheons 50x7 cyl. hole	77448635401	77448635403	77448635404	77448635409	77448635412	77448635433	10
COPPIA BOC 50x7 YALE Coppia bocchette 50x7 Yale attacco rapido Pair escutcheons 50x7 cyl. Hole speed connection	77448635401AR	77448635403AR	77448635404AR	77448635409AR	77448635412AR	77448635433AR	10

# ROS 50x7 VITI A VISTA

ALLUMINIO

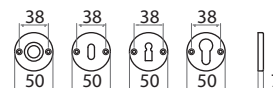

	F1	F3	F4	F9	Conf. Pz.
COPPIA ROS 50x7 F.20 V.V. Coppia rosette 50x7 F.20 viti vista pair of round roses 45x7 18mm hole	77448543001	77448543003	77448543004	77448543009	10
COPPIA BOC 50x7 PAT V.V. Coppia bocchette 50x7 patent viti vista Pair escutcheons 45x7 key hole	77448643001	77448643003	77448643004	77448643009	10
COPPIA BOC 50x7 YALE V.V. Coppia bocchette 50x7 Yale viti vista Pair escutcheons 50x7 cyl. hole	77448647001	77448647003	77448647004	77448647009	10
COPPIA BOC 50x7 BB V.V. Coppia bocchette 50x7 BB viti vista Pair escutcheons 50x7 BB hole	77448644001	77448644003	77448644004	77448644009	10

# ROS 52x10

ALLUMINIO

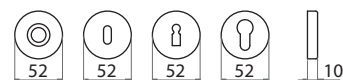

	F1	F3	F4	F9	GCTOL	F1-SAT	Conf. Pz.
COPPIA ROS. 52x10 F.18 Coppia rosette 52x10 F.18 pair of round roses 52x7 18mm hole	77398531301	77398531303	77398531304	77398531309	77398531312	77398531333	10
COPPIA BOC 52x10 PAT Coppia bocchette 52x10 patent Pair escutcheons 52x10 key hole	77398631301	77398631303	77398631304	77398631309	77398631312	77398631333	10
COPPIA BOC 52x10 BB Coppia bocchette 52x10 BB Pair escutcheons 52x10 BB key hole	77398631701	77398631703	77398631704	77398631709	77398631712	77398631733	10
COPPIA BOC 52x10 YALE Coppia bocchette 52x10 Yale Pair escutcheons 52x10 cyl hole	77398635301	77398635303	77398635304	77398635309	77398635312	77398635333	10

# ROS 30x60

ALLUMINIO

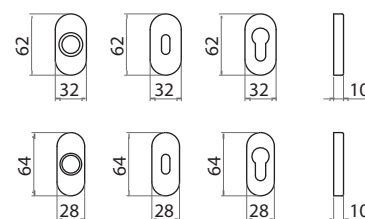

	F1	F3	F4	F9	GCTOL	F1-SAT	Conf. Pz.
COPPIA ROS 30x60 F.18 OVALE Coppia rosette 30x60 F.18 ovali pair of oval roses 30x60 18mm hole	77398521001	77398521003	77398521004	77398521009	77398521012	77398521033	10
COPPIA BOC 30x60 PAT OVALE Coppia bocchette 30x60 patent ovali Pair oval escutcheons 30x60 key hole	77398621001	77398621003	77398621004	77398621009	77398621012	77398621033	10
COPPIA BOC 30x60 YALE OVALE Coppia bocchette 30x60 Yale ovali Pair oval escutcheons 30x60 cyl. hole	77398625001	77398625003	77398625004	77398625009	77398625012	77398625033	10



# ROS 28x64

ALLUMINIO

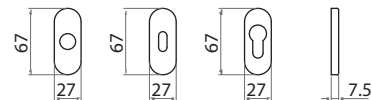

	F1	F3	F4	F9	GCTOL	F1-SAT	Conf. Pz.
COPPIA ROS 28x64 F.18 OVALE Coppia rosette 28x64 F.18 ovali pair of oval roses 28x64 18mm hole	77398522001	77398522003	77398522004	77398522009	77398522012	77398522033	10
COPPIA BOC 28X64 PAT OVALE Coppia bocchette 28x64 patent ovali Pair oval escutcheons 28x64 key hole	77398621501	77398621503	77398621504	77398621509	77398621512	77398621533	10
COPPIA BOC 28x64 YALE OVALE Coppia bocchette 28x64 Yale ovali Pair oval escutcheons 28x64 cyl. hole	77398625501	77398625503	77398625504	77398625509	77398625512	77398625533	10

# ROS 28x68 VITI A VISTA

ALLUMINIO

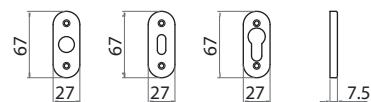

	F1	F3	F4	F9	Conf. Pz.
COPPIA ROS 28x68 F.20 OV V.V. Coppia rosette 28x68 F.20 ovali viti vista pair of oval roses 28x68 20mm hole	77448521001	77448521003	77448521004	77448521009	10
COPPIA BOC 28x68 PAT OV V.V. Coppia bocchette 28x68 patent ovali viti vista Pair oval escutcheons 28x64 key hole	77448621001	77448621003	77448621004	77448621009	10
COPPIA BOC 28x68 YALE OV V.V. Coppia bocchette 28x68 Yale ovali viti vista Pair oval escutcheons 28x64 cyl. hole	77448625001	77448625003	77448625004	77448625009	10

# ROS 30x60-00C6

ALLUMINIO



D. FORO 24MM

D. FORO 16MM

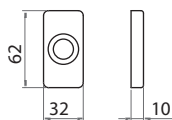

- SUPPORTO IN POLIMERO
- MANIGLIA STACCATA
- PREDISPOSTA PER MOLLA TRADIZIONALE DX O SX
- CON MANIGLIA SOLIDALE

- PLASTIC SUPPORT
- DETACHED HANDLE
- AVAILABLE FOR STANDARD SPRING LH/RH
- WITH FIXED HANDLE



D. FORO 16MM

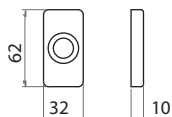

- SUPPORTO IN POLIMERO CON MOLLA
- AMBIDESTRA INSERITA
- MANIGLIA STACCATA

- PLASTIC SUPPORT WITH SPRING
- LOADED LH/RH
- DETACHED HANDLE

	F1	F3	F4	F9	GCTOL	F1-SAT	Conf. Pz.
ROS coppia	77498511501	77498511503	77498511504	77498511509	77498511512	77498511533	10
coppia ROS.RETT 30x60x9.5 ASSEMBL. s/molla							
pair of rectangular rose							
ROS coppia	77498511401	77498511403	77498511404	77498511409	77498511412	77498511433	10
coppia ROS.RETT 30x60x9.5 ASSEMBL. c/molla dx/sx							
pair of rectangular roses with spring							
BOC PATENT coppia	77498611501	77498611503	77498611504	77498611509	77498611512	77498611533	10
coppia BOC.RETT PATENT 30x60x9.5 ASSEMBL.							
pair of rectangular key hole escutcheons							
BOC YALE coppia	77498615501	77498615503	77498615504	77498615509	77498615512	77498615533	10
coppia BOC.RETT YALE 30x60x9.5 ASSEMBL.							
pair of rectangular cyl.hole escutcheons							

# ROS 50x50x10 - 574

ALLUMINIO

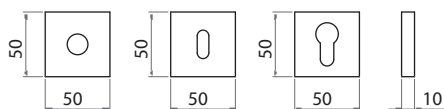

- SUPPORTO IN POLIMERO
- MOLLA TRADIZIONALE DX O SX
- MANIGLIA SOLIDALE
- PREDISPOSTA PER VITI PASSANTI INT. MM 38
- AUTOFILETTANTI O METRICHE

- PLASTIC SUPPORT
- STANDARD SPRING LH/RH
- HANDLE FIXED ON THE ROSE
- AVAILABLE FOR THROUGH BOLTS - SELF DRILLING SCREW/METRIC SCREWS

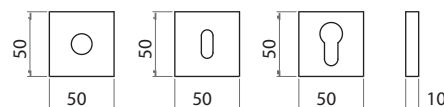

- SUPPORTO IN POLIMERO CON MOLLA
- AMBIDESTRA INSERITA
- MANIGLIA STACCATA
- PREDISPOSTA PER VITI PASSANTI INT. MM 38
- AUTOFILETTANTI O METRICHE

- PLASTIC SUPPORT WITH SPRING LOADED
- LH/RH
- DETACHED HANDLE
- AVAILABLE FOR THROUGH BOLTS - SELF DRILLING SCREW/METRIC SCREWS

	ACL	F1-SAT	Conf. Pz.
ROS	77498551817	77498551833	10
ROS.50X50 QUADRA ASSEMBL. F16 singola s/molla			
square rose			
ROS	77498551017	77498551033	10
ROS.50X50 QUADRA ASSEMBL. F16 singola c/molla			
square rose			
BOC PAT	77498651017	77498651033	10
BOC.50x50 PAT QUADRA ASSEMBL.			
square key escutcheon			
BOC YALE	77498655017	77498655033	10
BOC.50x50 YALE QUADRA ASSEMBL.			
square cyl. Escutcheon			

# NOTTOLINI WC

ALLUMINIO

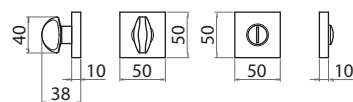

	F1	F3	F4	F9	Conf. Pz.
NOTT WC Q6 R50x50 Nottolino WC Q6 rosetta 50x50 Toilet set - spindle 6 mm with rose 50 x 50	77448668001	77448668003	77448668004	77448668009	10

# NOTTOLINI WC

ALLUMINIO

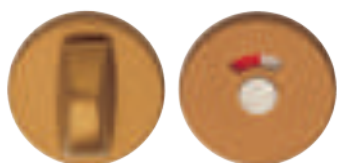

	F1	F3	F4	F9	Conf. Pz.
NOTT WC Q6 R50x7 Nottolino WC Q6 rosetta 50x7 Toilet set - spindle 6 mm with rose 50 x 7	77448638001	77448638003	77448638004	77448638009	10

# NOTTOLINI WC

ALLUMINIO

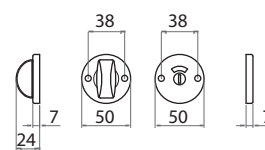

	F1	F3	F4	F9	Conf. Pz.
NOTT WC Q6 R50x7 V.V. Nottolino WC Q6 rosetta 50x7 viti vista Toilet set - spindle 6 mm with rose 50x7 visible screws	77448648001	77448648003	77448648004	77448648009	10

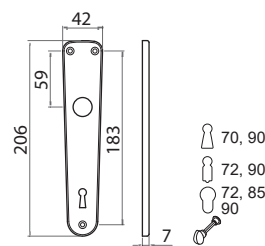

	F1	F3	F4	F9	Conf. Pz.
COPPIA PLACCHE B CH 90 PLACCA B P90 (coppia) pair of plate B hole CH 90	79010851001	79010851003	79010851004	79010851009	10
COPPIA PLACCHE B CH 70 PLACCA B P70 (coppia) pair of plate B hole CH 70	79010857001	79010857003	79010857004	79010857009	10
COPPIA PLACCHE B BB 72 PLACCA B P72 BB (coppia) pair of plate B hole BB 72	79010851601	79010851603	79010851604	79010851609	10
COPPIA PLACCHE B BB 90 PLACCA B P90 BB (coppia) pair of plate B hole BB 90	79010851201	79010851203	79010851204	79010851209	10
COPPIA PLACCHE B YALE 72 PLACCA B PY72 (coppia) pair of plate B hole cyl. 72	79010855601	79010855603	79010855604	79010855609	10
COPPIA PLACCHE B YALE 85 PLACCA B PY85 (coppia) pair of plate B hole cyl. 85	79010855001	79010855003	79010855004	79010855009	10
COPPIA PLACCHE B YALE 90 PLACCA B PY90 (coppia) pair of plate B hole cyl. 90	79010855901	79010855903	79010855904	79010855909	10
COPPIA PLACCHE B WC72 PLACCA B WC72 Q6 (coppia) pair of plate B hole wc 72	79010088601	79010088603	79010088604	79010088609	10
COPPIA PLACCHE B WC90 PLACCA B WC90 Q6 (coppia) pair of plate B hole wc 90	79010088001	79010088003	79010088004	79010088009	10

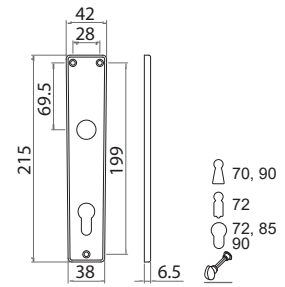

	F1	F3	F4	F9	Conf. Pz.
COPPIA PLACCHE I CH 90 PLACCA I P90 (coppia) pair of plate I hole CH 90	79060851001	79060851003	79060851004	79060851009	10
COPPIA PLACCHE I CH 70 PLACCA I P70 (coppia) pair of plate I hole CH 70	79060857001	79060857003	79060857004	79060857009	10
COPPIA PLACCHE I BB 72 PLACCA I P72 BB (coppia) pair of plate I hole BB 72	79060851601	79060851603	79060851604	79060851609	10
COPPIA PLACCHE I BB 90 PLACCA I P90 BB (coppia) pair of plate I hole BB 90	79060851201	79060851203	79060851204	79060851209	10
COPPIA PLACCHE I YALE 72 PLACCA I PY72 (coppia) pair of plate I hole cyl. 72	79060855601	79060855603	79060855604	79060855609	10
COPPIA PLACCHE I YALE 85 PLACCA I YA85 (coppia) pair of plate I hole cyl. 85	79060855001	79060855003	79060855004	79060855009	10
COPPIA PLACCHE I YALE 90 PLACCA I PY90 (coppia) pair of plate I hole cyl. 90	79060855901	79060855903	79060855904	79060855909	10
COPPIA PLACCHE I WC72 PLACCA I WC72 Q6 (coppia) pair of plate I hole wc 72	79060088601	79060088603	79060088604	79060088609	10
COPPIA PLACCHE I WC90 PLACCA I WC90 Q6 (coppia) pair of plate I hole wc 90	79060088001	79060088003	79060088004	79060088009	10

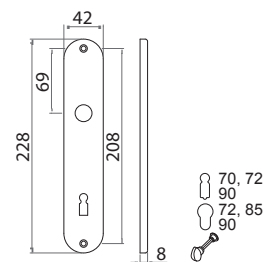

	F1	F3	F4	F9	Conf. Pz.
COPPIA PLACCHE S 2FV BB 70 PLACCA S P70BB 2VITI (coppia) pair of plate S 2FV hole BB 70	79120857201	79120857203	79120857204	79120857209	10
COPPIA PLACCHE S 2FV BB 72 PLACCA S P72BB 2VITI (coppia) pair of plate S 2FV hole BB 72	79120851601	79120851603	79120851604	79120851609	10
COPPIA PLACCHE S 2FV BB 90 PLACCA S P90BB 2VITI (coppia) pair of plate S 2FV hole BB90	79120851201	79120851203	79120851204	79120851209	10
COPPIA PLACCHE S 2FV YALE 72 PLACCA S PY72 2VITI (coppia) pair of plate S 2FV hole cyl.72	79120855601	79120855603	79120855604	79120855609	10
COPPIA PLACCHE S 2FV YALE 85 PLACCA S YA85 2VITI (coppia) pair of plate S 2FV hole cyl.85	79120855001	79120855003	79120855004	79120855009	10
COPPIA PLACCHE S 2FV YALE 90 PLACCA S PY90 2VITI (coppia) pair of plate S 2FV hole cyl.90	79120855901	79120855903	79120855904	79120855909	10
COPPIA PLACCHE S 2FV WC72 PLACCA S WC72 Q6 (coppia) pair of plate S 2FV wc 72	79120088601	79120088603	79120088604	79120088609	10
COPPIA PLACCHE S 2FV WC90 PLACCA S WC90 Q6 (coppia) pair of plate S 2FV wc 90	79120088001	79120088003	79120088004	79120088009	10

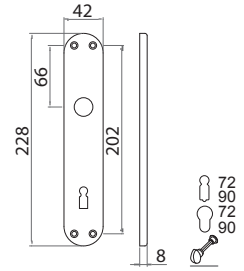

	F1	F3	F4	F9	Conf. Pz.
COPPIA PLACCHE S 4FV BB 72 PLACCA S P72BB 4VITI (coppia) pair of plate S 4FV hole BB72	79130851601	79130851603	79130851604	79130851609	10
COPPIA PLACCHE S 4FV BB 90 PLACCA S P90BB 4VITI (coppia) pair of plate S 4FV hole BB90	79130851201	79130851203	79130851204	79130851209	10
COPPIA PLACCHE S 4FV YALE 72 PLACCA S PY72 4VITI (coppia) pair of plate S 4FV hole cyl. 72	79130855601	79130855603	79130855604	79130855609	10
COPPIA PLACCHE S 4FV YALE 90 PLACCA S PY90 4VITI (coppia) pair of plate S 4FV hole cyl. 90	79130855901	79130855903	79130855904	79130855909	10
COPPIA PLACCHE S 4FV WC72 PLACCA S WC72 Q6 (coppia) pair of plate S 4FV wc 72	79130088601	79130088603	79130088604	79130088609	10
COPPIA PLACCHE S 4FV WC90 PLACCA S WC90 Q6 (coppia) pair of plate S 4FV wc 90	79130088001	79130088003	79130088004	79130088009	10

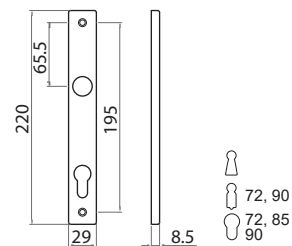

	F1	F3	F4	F9	Conf. Pz.
COPPIA PLACCHE X CH 90 Coppia placche X foro CH 90 pair of plate X hole CH90	79180851001	79180851003	79180851004	79180851009	10
COPPIA PLACCHE X CH 70 Coppia placche X foro CH 70 pair of plate hole CH70	79180857001	79180857003	79180857004	79180857009	10
COPPIA PLACCHE X BB 72 Coppia placche X foro BB 72 pair of plate X hole BB72	79180851601	79180851603	79180851604	79180851609	10
COPPIA PLACCHE X BB 90 Coppia placche X foro BB 90 pair of plate X hole BB90	79180851201	79180851203	79180851204	79180851209	10
COPPIA PLACCHE X YALE 72 Coppia placche X foro Yale 72 pair of plate X hole cyl.72	79180855601	79180855603	79180855604	79180855609	10
COPPIA PLACCHE X YALE 85 Coppia placche X foro Yale 85 pair of plate X hole cyl 85	79180855001	79180855003	79180855004	79180855009	10



## PLACCA FO24

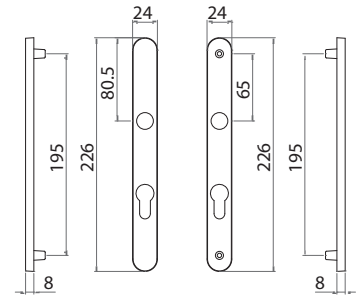

DISPONIBILE A RICHIESTA PER APPLICAZIONI SPECIALI  
AVAILABLE ON REQUEST FOR SPECIAL APPLICATIONS

## PLACCA FO32

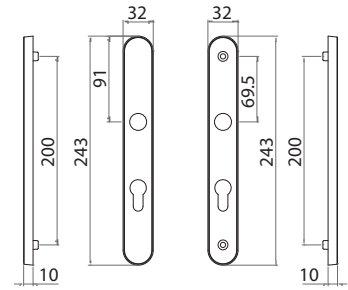

DISPONIBILE A RICHIESTA PER APPLICAZIONI SPECIALI  
AVAILABLE ON REQUEST FOR SPECIAL APPLICATIONS

# PLACCA FO40

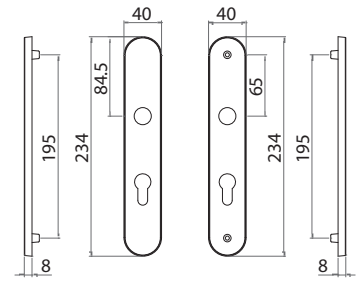

DISPONIBILE A RICHIESTA PER APPLICAZIONI SPECIALI  
AVAILABLE ON REQUEST FOR SPECIAL APPLICATIONS

# PLACCA FR40

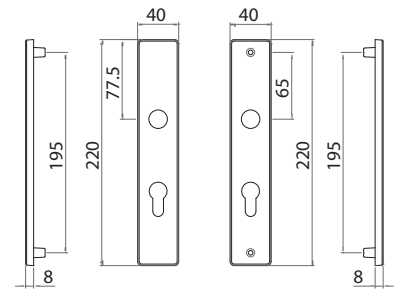

DISPONIBILE A RICHIESTA PER APPLICAZIONI SPECIALI  
AVAILABLE ON REQUEST FOR SPECIAL APPLICATIONS

## GIOCHI DK/DK MECHANISM

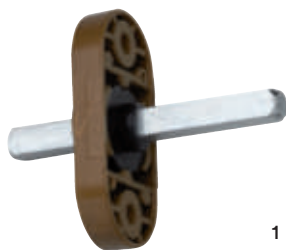

1

	NOR	NAR	Conf. Pz.
GIOCO DK Q7x30 OVALE Gioco DK Q7x30 ovale Window mechanism	18340000114	18340000115	10
GIOCO DK Q7x33 OVALE Gioco DK Q7x33 ovale Window mechanism	18340000214	18340000215	10
GIOCO DK Q7x40 OVALE Gioco DK Q7x40 ovale Window mechanism	18340000414	18340000415	10
GIOCO DK Q7x45 OVALE Gioco DK Q7x45 ovale Window mechanism	18340000514	18340000515	10



2

GIOCO DK Q7x30 OVALE C/BUSSOLE D.9,5 Gioco DK Q7x30 ovale con bussole D.9,5 Window mechanism	18340100114	18340100115	10
GIOCO DK Q7x33 OVALE C/BUSSOLE D.9,5 Gioco DK Q7x33 ovale con bussole D.9,5 Window mechanism	18340100214	18340100215	10
GIOCO DK Q7x40 OVALE C/BUSSOLE D.9,5 Gioco DK Q7x40 ovale con bussole D.9,5 Window mechanism	18340100414	18340100415	10
GIOCO DK Q7x45 OVALE C/BUSSOLE D.9,5 Gioco DK Q7x45 ovale con bussole D.9,5 Window mechanism	18340100514	18340100515	10



4

GIOCO DK NYLON PER MARTELLINE CON FORO Q7 PASSANTE Gioco DK nylon per martelline con foro Q7 passante Window mechanism	18342500011		10
--	-------------	--	----

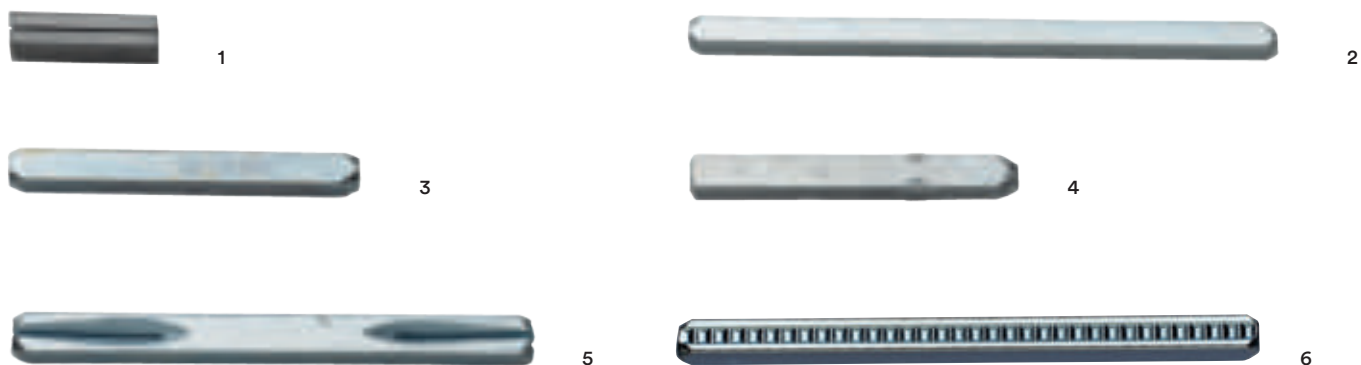

	FE/ZB	Conf. Pz.
Maggiorazione 6x7x20 ferro Adaptor spindle 6 x 7 x 20	13280000011	
Maggiorazione 6x8x20 ferro Adaptor spindle 6 x 8 x 20	13280100011	
Maggiorazione 7x8x20 ferro Adaptor spindle 7 x 8 x 20	13280200011	
FERRO Q6x120 SENZA TAGLI Ferro Q6x120 senza tagli spindle 6mm x 120 without cutting	13210012070	
FERRO Q7x65 SENZA TAGLI Ferro Q7x65 senza tagli Spindle 7 x 65mm without cutting	13220006570	
FERRO Q7x70 SENZA TAGLI Ferro Q7x70 senza tagli spindle 7 x 70mm without cutting	13220007070	
FERRO Q7x75 SENZA TAGLI Ferro Q7x75 senza tagli spindle 7 x 75mm without cutting	13220007570	
FERRO Q7x59 (DK FISSO SPORG.30) Ferro Q7x59 (DK fisso sporg.30) Spindle DK	13225006170	
FERRO Q7x62 (DK FISSO SPORG.33) Ferro Q7x62 (DK fisso sporg.33) Spindle DK	13225000170	
FERRO Q7x64 (DK FISSO SPORG.35-30) Ferro Q7x64 (DK fisso sporg.35-30) Spindle DK	13225006670	
FERRO Q7x69 (DK FISSO SPORG.40-35) Ferro Q7x69 (DK fisso sporg.40-35) Spindle DK	13225007170	
Ferro Q8x74 (DK fisso sporg.45-40) special spindle 8 x 74mm for DK	13225007670	
Ferro Q8x100 2 tagli + fresatura spindle 8 x 100 mm	13230410070	
Ferro Q8x120 2 tagli + fresatura spindle 8 x 120mm	13230412070	
Ferro Q8x140 2 tagli + fresatura spindle 8 x 140 mm	13230414070	
Ferro Q8x160 2 tagli + fresatura spindle 8 x 160 mm	13230416070	
FERRO Q.8x 100 TK ferro Q.8X100 TK spindle 8 x 100 mm	13233710070	
FERRO Q.8x 120 TK ferro Q.8X120 TK spindle 8 x120 mm	13233712070	
FERRO Q.8x 140 TK ferro Q.8X140 TK spindle 8 x 140 mm	13233714070	
FERRO Q.8x 160 TK ferro Q.8X160 TK spindle 8 x 160 mm	13233716070	
FERRO Q6x1000 (VERGA) Ferro Q6x1000 (verga) spindle 6mm x 1'000 ( rod)	13175610011	
FERRO Q7x1000 (VERGA) Ferro Q7x1000 (verga) spindle 7mm x 1000 ( rod)	13175710011	
FERRO Q8x1000 (VERGA) Ferro Q8x1000 (verga) spindle 8mm x 1000 ( rod)	13175810011	

# FERRI/SPINDLES



	FE/ZB	Conf. Pz.
Ferro Q8x43 ad espansione special spindle 8 x 43mm	13230500006	
Ferro Q8x55 ad espansione special spindle 8 x 55mm	13230500106	
Ferro Q8x65 ad espansione special spindle 8 x 65mm	13230500206	
Ferro Q8x80 ad espansione special spindle 8 x 80mm	13230500306	
	FE/ZB	Conf. Pz.
Ferro Q8x95 con nipler MB 14 folle spindle 8 x 95mm with nipler M 14 free	13230600070	
Ferro Q8x100 con nipler MB 14 folle spindle 8 x 100mm with nipler MB 14 free	13230600170	
Ferro Q8x105 con nipler MB 14 folle spindle 8 x 105mm with nipler MB 14 free	13230600270	
Ferro Q8x110 con nipler MB 14 folle spindle 8 x 110mm with nipler MB 14 free	13230600370	
Ferro Q8x110 con nipler MB 14 folle spindle 8 x 110mm with nipler MB 14 free	13230600570	
Ferro Q8x130 con nipler MB 14 folle spindle 8 x 130mm with nipler MB 14 free	13230600670	
Ferro Q8x115 con nipler MB 14 folle spindle 8 x 115mm with nipler MB 14 free	13233600170	
Ferro Q8x100 con nipler M10 folle spindle 8 x 100mm with nipler M 10 free	13233600270	
Ferro Q8x110 con nipler M10 folle spindle 8 x 110mm with nipler M 10 free	13233609570	
Ferro Q8x95 con nipler M10 folle spindle 8 x 95mm with nipler M 10 free	13233610570	
Ferro Q8x105 con nipler M10 folle spindle 8 x 105mm with nipler M 10 free	13233611570	
Ferro Q8x115 con nipler M10 folle spindle 8 x 115mm with nipler M 10 free	13233612070	
Ferro Q8x120 con nipler M10 folle spindle 8 x 120mm with nipler M 10 free	13233613070	
Ferro Q8x130 con nipler M10 folle spindle 8 x 130mm with nipler m 10 free		

# FERRI CON PIASTRINE/SPINDLES WITH PLATELETS



	FOLLE	Conf. Pz.
Ferro Q8x100 con piastrina Q8x30 folle special spindle 8 x 100mm	13230800070	
Ferro Q8x85 con piastrina Q8x30 folle special spindle 8 x 85mm	13230800170	
Ferro Q8x70 con piastrina Q8x30 folle special spindle 8 x 70mm	13230800270	

# PIASTRINE/PLATELETS



	FE/ZB
Piastrina D.32 Q8x25 item for fixing lever handle or knob	13320010270
Piastrina D.32 c/vite M8x25 item for fixing lever handle or knob	13320110070

# VITI/SCREWS

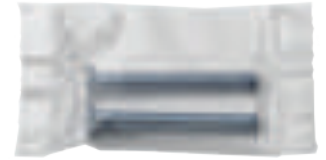

CONF.098* 2VITI TPS+M5X40	FE/ZB	Conf. Pz.	19000001770
CONF.144* 2VITI TPS+M5X45			19000004870
CONF.146* 10VITI TP+3X16	TROP	Conf. Pz.	19000005006
CONF.147* 4VITI TGS+3,5X25	OTTONATE	Conf. Pz.	19000005101
CONF.148* 8VITI TGS+3,5X25			19000005201
CONF.149*500 VITI DIN 965	FE/ZB	Conf. Pz.	19000005370
CONF.150*500 VITI DIN 965			19000005470
CONF.151*500 VITI DIN 965			19000005570
CONF.152*500 VITI DIN 965			19000005670
CONF.177* 2VITI TPS+M5X35			19000006770
CONF.220* 2VITI TPS+ M5x50			19000008570





# 4

**Coordinati per  
porte scorrevoli**

**Sliding door  
accessories**

350 Alluminio galattico / Galactic aluminum  
352 Zama / Zamak  
360 Ottone / Brass  
361 Alluminio / Aluminum

# SCORRI TONDO CIECO

ALLUMINIO GALATTICO

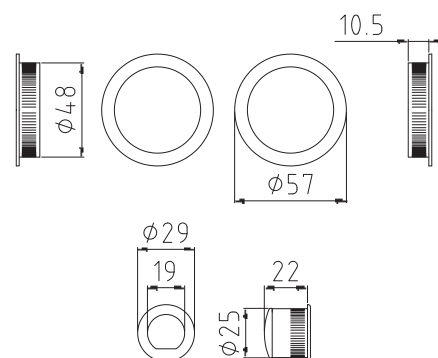

Mont. n°123

	MERCURY	URANUS	JUPITER	SPACE	Conf. Pz.
SCORRI TONDO CIECO	7704871613390	7704871613490	7704871614190	7704871617690	4
Square sliding door	⚡	⚡	⚡	⚡	

⚡ Servizio G48: Articolo a magazzino e disponibile entro 48 dall'elaborazione dell'ordine. In base a disponibilita' e condizioni di vendita.  
G48 service: Item in stock and available within 48 hours of order processing. Based on availability and sales conditions.

# SCORRI TONDO BLOCC S/SERRATURA

ALLUMINIO GALATTICO

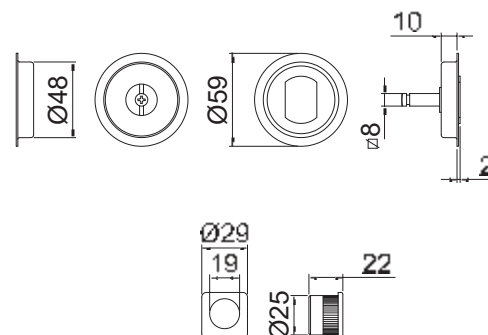
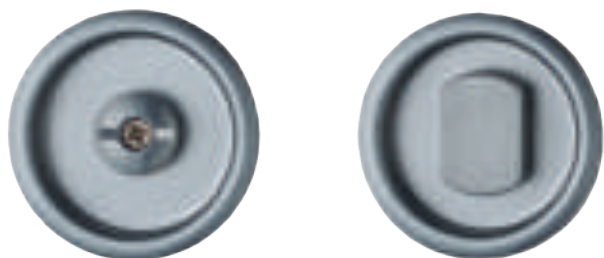

Mont. n°122

	MERCURY	URANUS	JUPITER	SPACE	Conf. Pz.
SCORRI TONDO BLOCC s/serratura	7704871913390	7704871913490	7704871914190	7704871917690	1
Sliding door handle without lock	⚡	⚡	⚡	⚡	

⚡ Servizio G48: Articolo a magazzino e disponibile entro 48 dall'elaborazione dell'ordine. In base a disponibilita' e condizioni di vendita.  
G48 service: Item in stock and available within 48 hours of order processing. Based on availability and sales conditions.



Per istruzioni di montaggio scansiona QR code, seleziona il numero di riferimento e segui le istruzioni.  
For assembly instructions scan the QR code, select the relevant assembly number and follow the instructions.

# SCORRI QT CIECO

ALLUMINIO GALATTICO

351

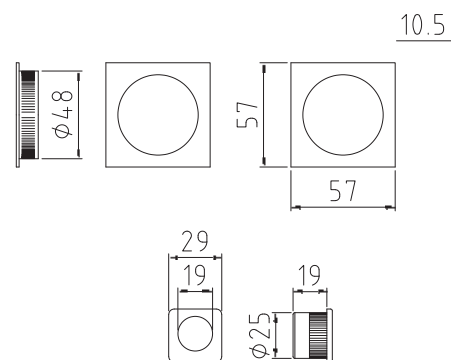

Mont. n°120

	MERCURY	URANUS	JUPITER	SPACE	Conf. Pz.
SCORRI QT CIECO	7704872463390	7704872463490	7704872464190	7704872467690	4
Square slidding door handle	⚡	⚡	⚡	⚡	

⚡ Servizio G48: Articolo a magazzino e disponibile entro 48 dall'elaborazione dell'ordine. In base a disponibilita' e condizioni di vendita.  
G48 service: Item in stock and available within 48 hours of order processing. Based on availability and sales conditions.

# SCORRI QT BLOCC S/SERRATURA

ALLUMINIO GALATTICO

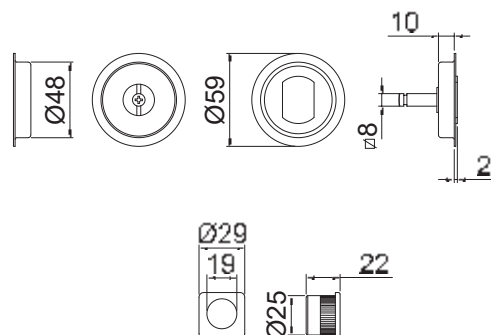

Mont. n°117

	MERCURY	URANUS	JUPITER	SPACE	Conf. Pz.
SCORRI QT BLOCC s/serratura	7704872413390	7704872413490	7704872414190	7704872417690	1
Square sliding door handle without lock	⚡	⚡	⚡	⚡	

⚡ Servizio G48: Articolo a magazzino e disponibile entro 48 dall'elaborazione dell'ordine. In base a disponibilita' e condizioni di vendita.  
G48 service: Item in stock and available within 48 hours of order processing. Based on availability and sales conditions.



Per istruzioni di montaggio scansiona QR code, seleziona il numero di riferimento e segui le istruzioni.  
For assembly instructions scan the QR code, select the relevant assembly number and follow the instructions.

# SCORRI TONDO CIECO

ZAMA

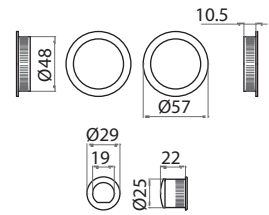
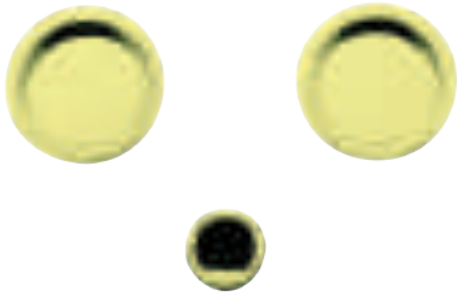

Mont. n°123

	ZCL	ZCS	ZNO	RAL9010	Z-BGO	Conf. Pz.
SCORRI TONDO CIECO	6GM9871600790	6GM9871601390	6GM9871601690	6GM9871606390	6GM9871606490	
sliding door	⚡	⚡	⚡	⚡	⚡	
	ZBR	ZGV	GCTOL	Z-OLD	Z-OSO	Conf. Pz.
SCORRI TONDO CIECO	6GM9871600090	6GM9871600490	6GM9871601290	6GM9871602890	6GM9871606690	
sliding door	⚡	⚡	⚡	⚡	⚡	

⚡ Servizio G48: Articolo a magazzino e disponibile entro 48 dall'elaborazione dell'ordine. In base a disponibilità e condizioni di vendita.  
G48 service: Item in stock and available within 48 hours of order processing. Based on availability and sales conditions.

# SCORRI TONDO PATENT

ZAMA

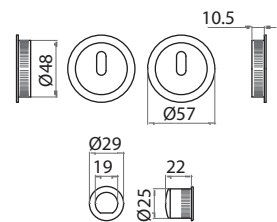

Mont. n°124

	OBR	ZCL	GCTOL	ZCS	Conf. Pz.
SCORRI TONDO PATENT	55748717000	6GM98717007	6GM98717012	6GM98717013	4
sliding door					



Per istruzioni di montaggio scansiona QR code, seleziona il numero di riferimento e segui le istruzioni.  
For assembly instructions scan the QR code, select the relevant assembly number and follow the instructions.

# KIT SCORRI TONDO BLOCC C/SERR ECO

ZAMA

353

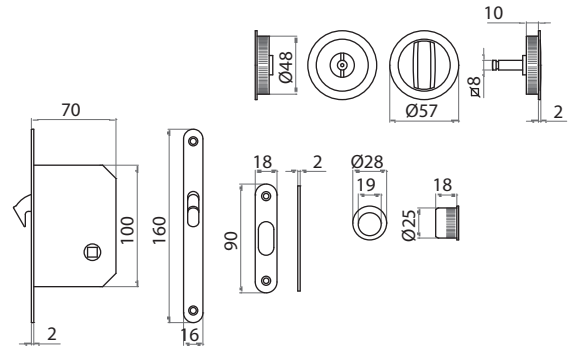
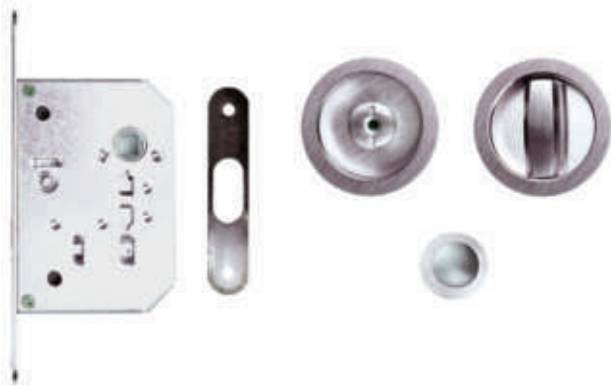

Mont. n°122

ADATTO PER SPESSORE PANNELLO mm 44, ± 1mm

	ZCL	GCTOL	ZCS	Conf. Pz.
KIT SCORRI TONDO BLOCC c/serratura eco	66048718807	66048718812	66048718813	1
Sliding door handle with lock				

# KIT SCORRI TONDO BLOCCO C/SERR

ZAMA

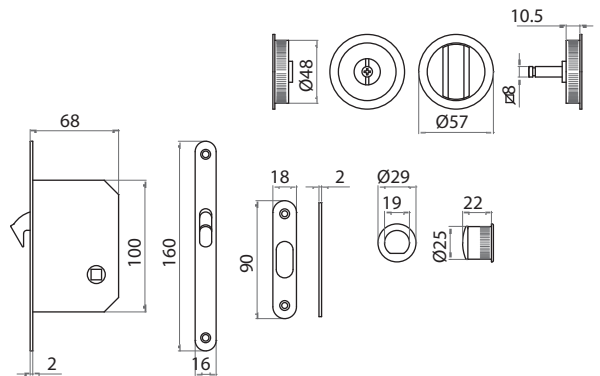

Mont. n°122

ADATTO PER SPESSORE PANNELLO mm 44, ± 1mm

	ZCL	GCTOL	ZCS	ZNO	RAL9010	Conf. Pz.
KIT SCORRI TONDO BLOCC c/serratura	6GM98718807	6GM98718812	6GM98718813	6GM98718816	6GM98718863	1
Sliding door handle with lock						
	ZGV	Z-OLD	ZBR	Z-BGO	Z-OSO	Conf. Pz.
KIT SCORRI TONDO BLOCC c/serratura	6GM98718804	6GM98718828	6GM98718800	6GM98718864	6GM98718866	1
Sliding door handle with lock						



Per istruzioni di montaggio scansiona QR code, seleziona il numero di riferimento e segui le istruzioni.  
For assembly instructions scan the QR code, select the relevant assembly number and follow the instructions.

# SCORRI TONDO BLOCC S/SERR

ZAMA

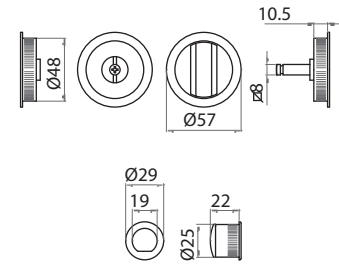

Mont. n°122

ADATTO PER SPESSORE PANNELLO mm 44, ± 1mm

	ZCL	GCTOL	ZCS	ZNO	RAL9010	Conf. Pz.
SCORRI TONDO BLOCC s/serratura	6GM9871800790	6GM9871801290	6GM9871801390	6GM9871801690	6GM9871806390	1
Sliding door handle without lock	⚡	⚡	⚡	⚡	⚡	
	ZBR	ZGV	Z-OLD	Z-BGO	Z-OSO	Conf. Pz.
SCORRI TONDO BLOCC s/serratura	6GM9871800090	6GM9871800490	6GM9871802890	6GM9871806490	6GM9871806690	1
Sliding door handle without lock	⚡	⚡	⚡	⚡	⚡	

⚡ Servizio G48: Articolo a magazzino e disponibile entro 48 dall'elaborazione dell'ordine. In base a disponibilità e condizioni di vendita.  
 G48 service: Item in stock and available within 48 hours of order processing. Based on availability and sales conditions.

# KIT SCORRI TONDO PATENT C/SERR

ZAMA

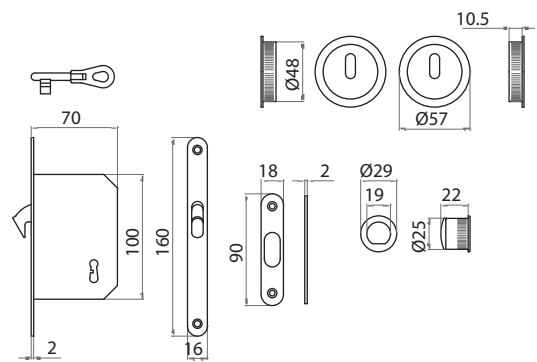

Mont. n°124

	OBR	ZCL	GCTOL	ZCS	Conf. Pz.
KIT SCORRI TONDO PATENT c/serratura	55748717800	6GM98717807	6GM98717812	6GM98717813	1
Sliding door handle key hole with lock					



Per istruzioni di montaggio scansiona QR code, seleziona il numero di riferimento e segui le istruzioni.  
 For assembly instructions scan the QR code, select the relevant assembly number and follow the instructions.

# KIT SCORRI TONDO BLOCC C/SERR PEND

ZAMA

355

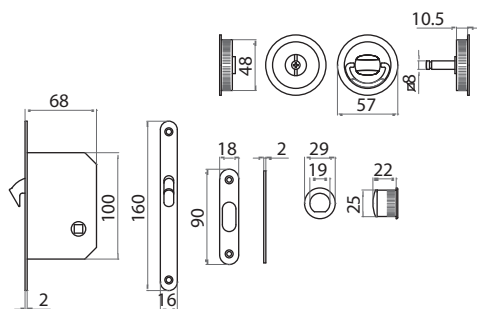

Mont. n°122

	ZCL	GCTOL	ZCS	Conf. Pz.
KIT SCORRI TONDO BLOCC c/serratura pendente	66098718907	66098718912	66098718913	1
Sliding door handle with lock				

# TRASCINATORE TONDO

OTTONE

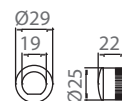

	OBR	OLV	OCS	OCL	Conf. Pz.
TRASCINATORE PORTE SCORR	55748710000	55748710001	55748710003	55748710007	10
round handle for sliding door					



Per istruzioni di montaggio scansiona QR code, seleziona il numero di riferimento e segui le istruzioni.  
For assembly instructions scan the QR code, select the relevant assembly number and follow the instructions.



# SCORRI Q CIECO

ZAMA

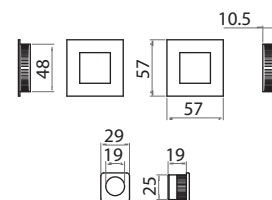

Mont. n°115

SCORRI Q CIECO

ZCL	ZCS	Conf. Pz.
66148726007	66148726013	4

Square sliding door

# SCORRI Q PATENT

ZAMA

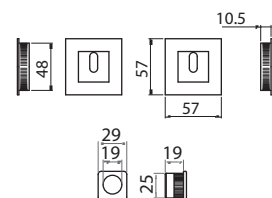

Mont. n°116

SCORRI Q PATENT

ZCL	ZCS	Conf. Pz.
66148727007	66148727013	4

Square sliding door key hole

# SCORRI Q PATENT C/SERR

ZAMA

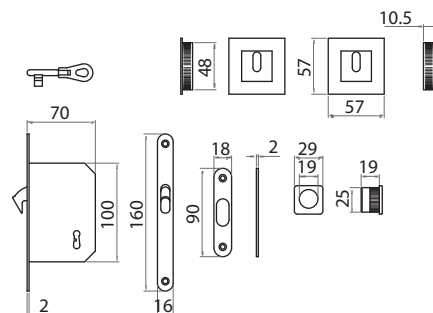
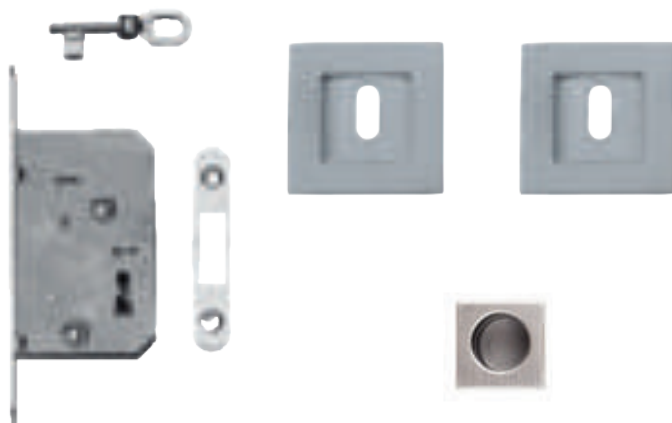

Mont. n°118

KIT SCORRI Q PATENT c/serratura

ZCL	ZCS	Conf. Pz.
66148727807	66148727813	1

Sliding door handle key hole with lock

# SCORRI QT CIECO

ZAMA

357

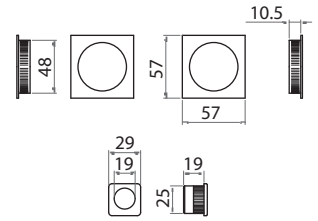

Mont. n°120

	ZCS	ZNO	RAL9010	Z-BGO	Z-OSO	Conf. Pz.
SCORRI QT CIECO	6614872401390	6614872401690	6614872406390	6614872406490	6614872406690	4
Square sliding door	⚡	⚡	⚡	⚡	⚡	

# SCORRI QT PATENT

ZAMA

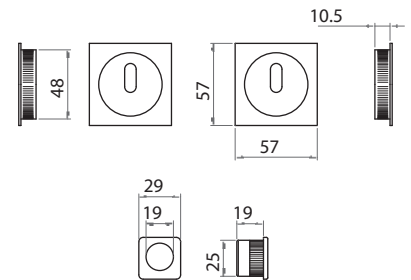

Mont. n°119

	ZCL	ZCS	Conf. Pz.
SCORRI QT PATENT	66148725007	66148725013	4
Square sliding door key door			

# KIT SCORRI QT BLOCC SERR. ECO

ZAMA

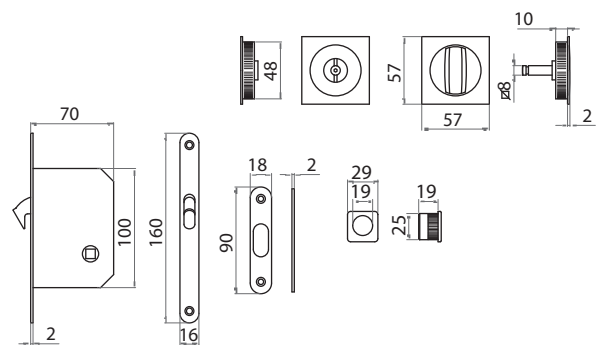

Mont. n°117

	ZCL	GCTOL	ZCS	Conf. Pz.
KIT SCORRI QT BLOCC c/serratura eco	66048724807	66048724812	66048724813	1
Square sliding door handle with lock				

# KIT SCORRI QT BLOCC C/SERR

ZAMA

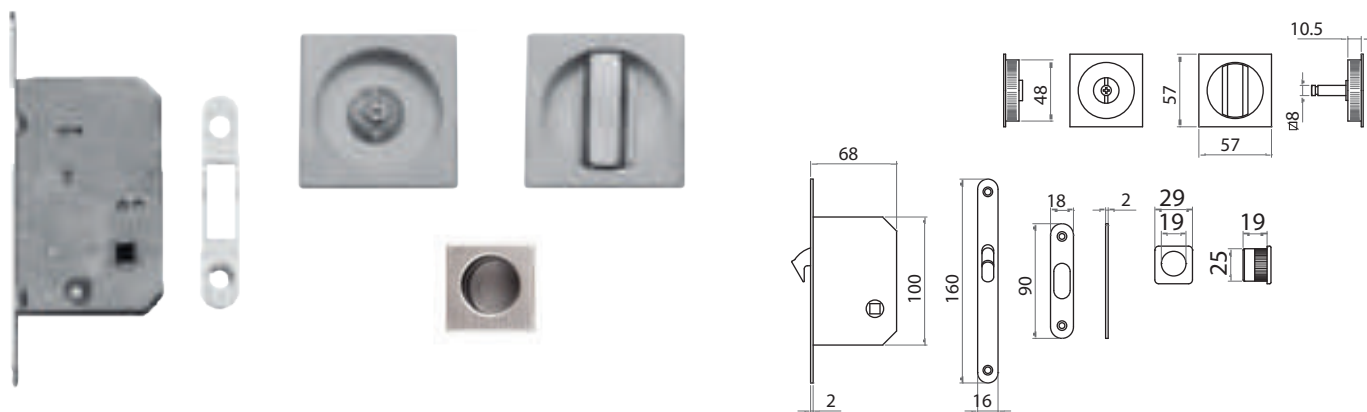

Mont. n°117

	ZCL	ZCS	ZNO	RAL9010	Z-BGO	Z-OSO	Conf. Pz.
KIT SCORRI QT BLOCC c/serratura	66148724807	66148724813	66148724816	66148724863	66148724864	66148724866	1
Square sliding door handle with lock							

# SCORRI QT BLOCC S/SERR

ZAMA

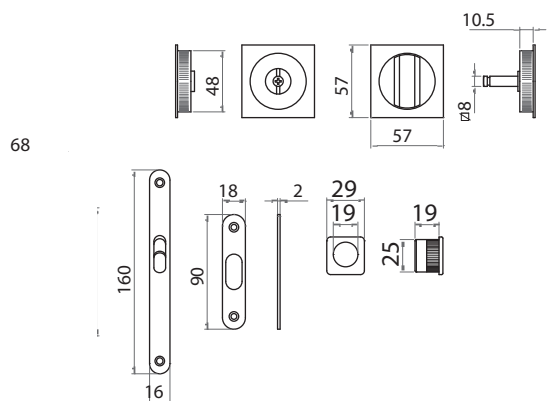

Mont. n°117

	ZCL	ZCS	ZNO	RAL9010	Z-BGO	Z-OSO	Conf. Pz.
SCORRI QT BLOCC s/serratura	6614872420790	6614872421390	6614872421690	6614872426390	6614872426490	6614872426690	1
Square sliding door handle without lock							

⚡ Servizio G48: Articolo a magazzino e disponibile entro 48 dall'elaborazione dell'ordine. In base a disponibilita' e condizioni di vendita.  
G48 service: Item in stock and available within 48 hours of order processing. Based on availability and sales conditions.



Per istruzioni di montaggio scansiona QR code, seleziona il numero di riferimento e segui le istruzioni.  
For assembly instructions scan the QR code, select the relevant assembly number and follow the instructions.

# KIT SCORRI QT PATENT C/SERR

ZAMA

359

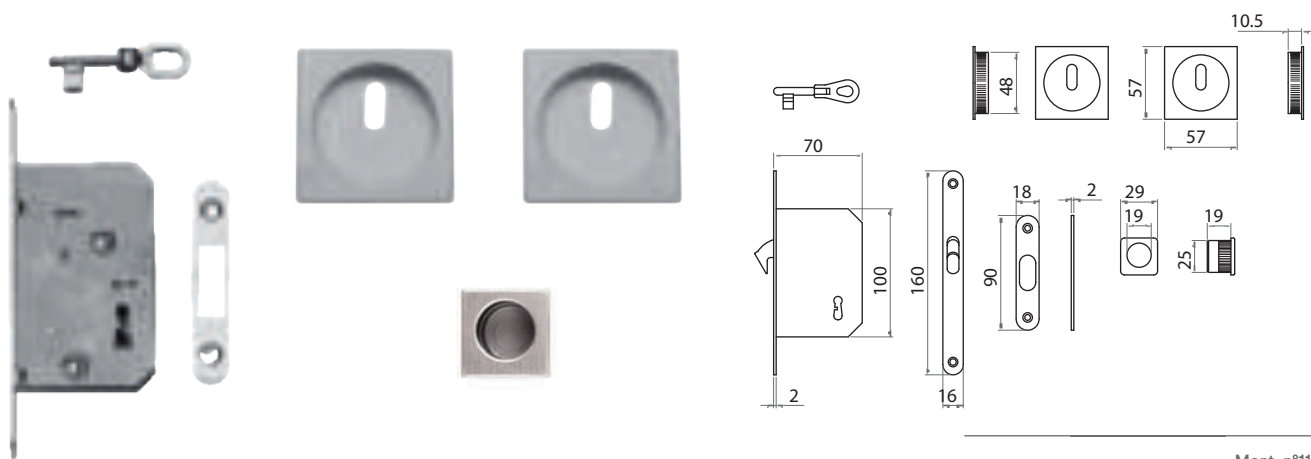

Mont. n°118

KIT SCORRI QT PATENT c/serratura

ZCL	ZCS	Conf. Pz.
66148725807	66148725813	1

Square sliding door key hole with lock

# TRASCINATORE Q

ZAMA

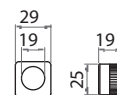

TRASCINATORE PORTE SCORR

OLV	OCS	OCL	Conf. Pz.
55748710501	55748710503	55748710507	10

square handle for sliding door

# ELY

OTTONE

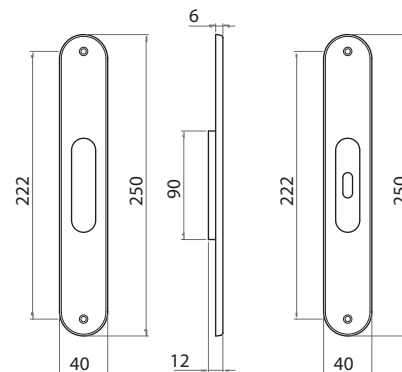

PLAC INCAS S/F

OLV	OCS	OGV	OCL	OS	Conf. Pz.
55048750001	55048750003	55048750004	55048750007	55048750008	6

sliding door handle blind  
PLACC INCAS PAT

55048751001	55048751003	55048751004	55048751007	55048751008	6
-------------	-------------	-------------	-------------	-------------	---

sliding door handle key hole

# OVALE COPRIVITI

OTTONE

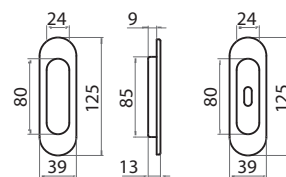

	OLV	OCS	OGV	OCL	OS	Conf. Pz.
INCASSO OVALE COP S/F	55798700001	55798700003	55798700004	55798700007	55798700008	6
sliding door handle						
INCASSO OVALE COP PAT	55798701001	55798701003	55798701004	55798701007	55798701008	6
sliding door handle						

# GIOIA

OTTONE

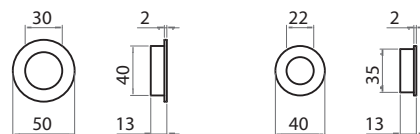

	OLV	OCS	OGV	OCL	OS	Conf. Pz.
INCAS MM 35 TON	55448735001	55448735003	55448735004	55448735007	55448735008	10
Round sliding door mm.35						
INCAS MM 40 TON	55448740001	55448740003	55448740004	55448740007	55448740008	10
Round sliding door mm.40						

# R95

OTTONE

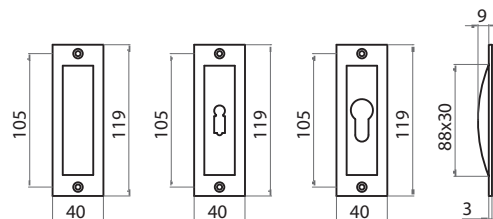

	OCS	OF	OCL	ONS	ONL	Conf. Pz.
NICCHIA CIECA	R009500000003	R009500000006	R009500000007	R009500000027	R009500000030	10
sliding door handle						
NICCHIA foro BB	R009600001203	R009600001206	R009600001207	R009600001227	R009600001230	10
sliding door handle key hole						
NICCHIA foro YALE	R009600005003	R009600005006	R009600005007	R009600005027	R009600005030	10
sliding door handle cylinder hole						

# SCORRI TONDO CIECO

ALLUMINIO

361

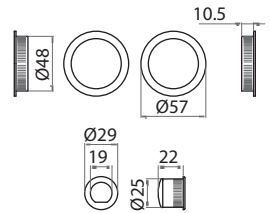

Mont. n°123

SCORRI TONDO CIECO

Square sliding door

F1	F4	Conf. Pz.
77048716001	77048716004	4

# SCORRI TONDO PATENT

ALLUMINIO

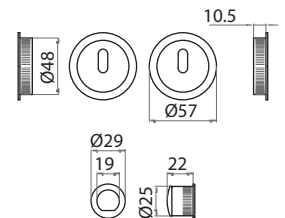

Mont. n°124

SCORRI TONDO PATENT

Square sliding door key hole

F1	F4	Conf. Pz.
77048717001	77048717004	4

# SCORRI TONDO BLOCC C/SERR

ALLUMINIO

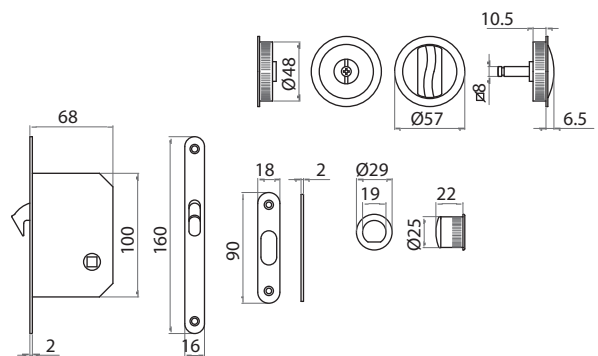

Mont. n°122

KIT SCORRI TONDO BLOCC c/serratura

Sliding door handle with lock

F1	F4	Conf. Pz.
77048718801	77048718804	1

# SCORRI TONDO PATENT C/SERR

ALLUMINIO

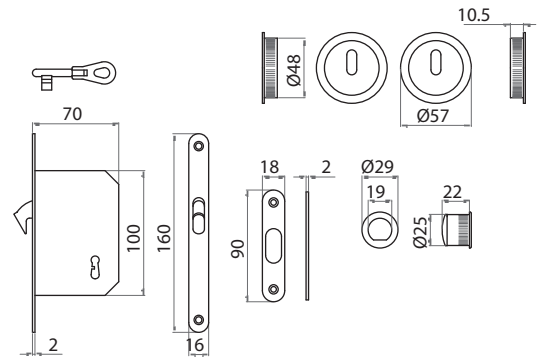
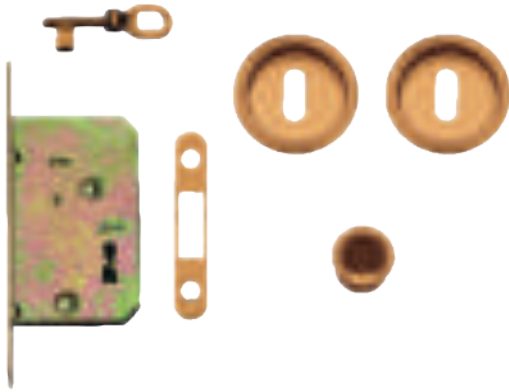

ADATTO PER SPESSORE PANNELLO mm 44, ± 1mm

Mont. n°124

KIT SCORRI TONDO PATENT c/serratura

F1	F4	Conf. Pz.
77048717801	77048717804	1

Sliding door handle key hole with lock

# TRASCINATORE TONDO

ALLUMINIO

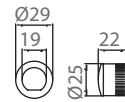

TRASCINATORE PORTE SCORR

F1	F4	Conf. Pz.
77048710001	77048710004	10

round handle for sliding door

# SCORRI QT CIECO

ALLUMINIO

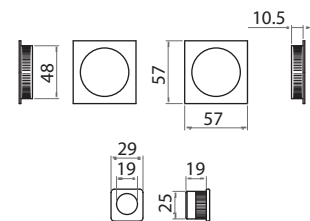

Mont. n°120

SCORRI QT CIECO

F1	Conf. Pz.
77048724001	4

Square sliding door handle

# SCORRI QT PATENT

ALLUMINIO

363

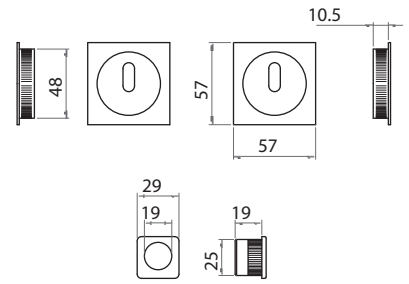
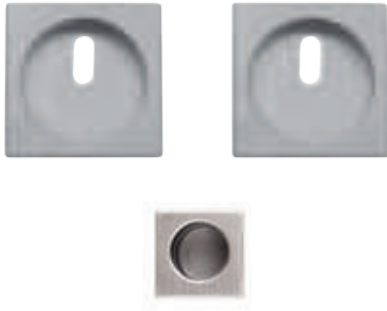

Mont. n°119

SCORRI QT PATENT

F1 Conf. Pz.  
77048725001 4

Sliding door handle key hole

# KIT SCORRI QT PATENT C/SERR

ALLUMINIO

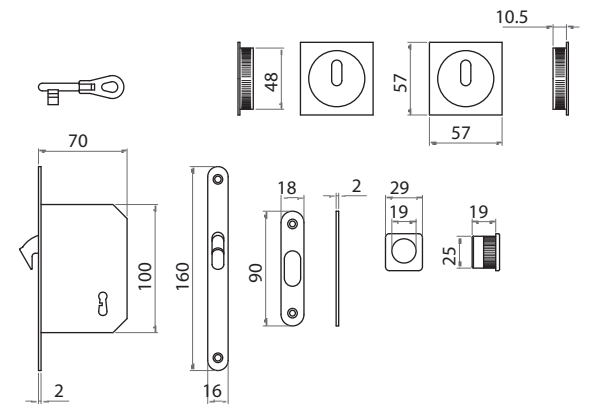

Mont. n°121

KIT SCORRI QT PATENT c/serratura

F1 Conf. Pz.  
77048725801 1

Square sliding door key hole with lock

# KIT SCORRI QT BLOCC C/SERR

ALLUMINIO



ADATTO PER SPESSORE PANNELLO mm 44, ± 1mm

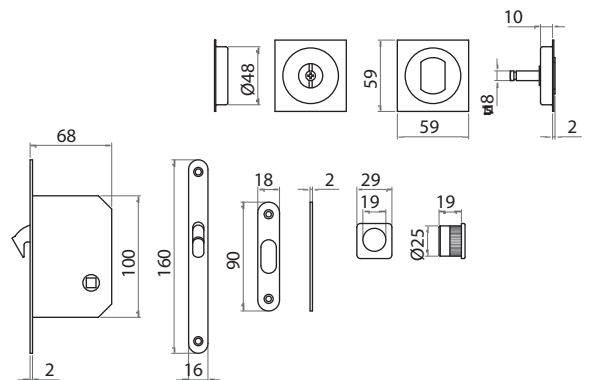

Mont. n°117

KIT SCORRI QT BLOCC c/serratura

F1 Conf. Pz.  
77048724801 1

Square sliding door kit with lock



## GABRY

ALLUMINIO

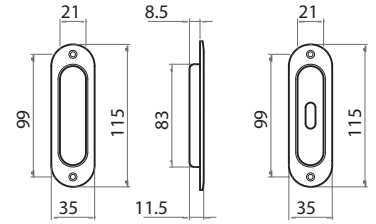
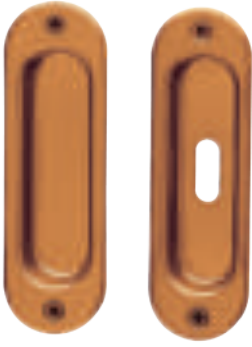

	F1	F4	Conf. Pz.
INCAS S/F	77498700001	77498700004	10
sliding door handle			
INCAS PAT	77498701001	77498701004	10
sliding door handle			

## 6009

ALLUMINIO

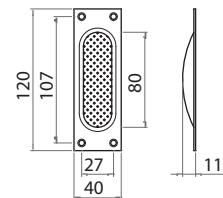
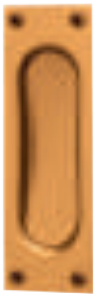

	F1	F4	Conf. Pz.
INCAS S/F	76009700001	76009700004	10
sliding door handle			



Per istruzioni di montaggio  
scansiona QR code,  
seleziona il numero di  
riferimento e segui le  
istruzioni.  
For assembly instructions  
scan the QR code, select the  
relevant assembly number  
and follow the instructions.

# KIT SCORRI TONDO BLOCC C-S/SERR. SMART

ZAMA - ALLUMINIO

365

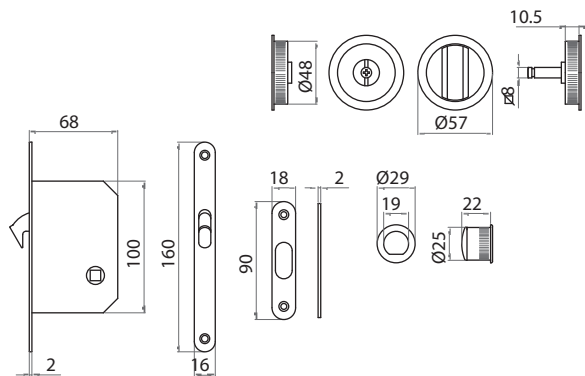

Mont. n°122

	ZCS/F1-SAT	Conf. Pz.
SCORRI TONDO BLOCC s/serratura SMART	66248714213	1
Sliding door handle without lock		
SCORRI TONDO BLOCC c/serratura SMART	66248714813	1
Sliding door handle with lock		

⚡ Servizio G48: Articolo a magazzino e disponibile entro 48 dall'elaborazione dell'ordine. In base a disponibilita' e condizioni di vendita.  
G48 service: Item in stock and available within 48 hours of order processing. Based on availability and sales conditions.

# KIT SCORRI QT BLOCC C-S/SERR. SMART

ZAMA - ALLUMINIO

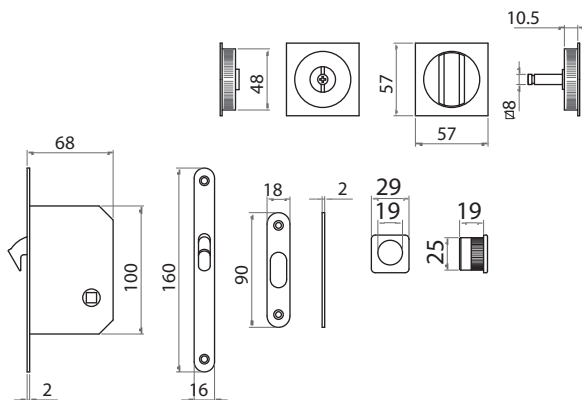

Mont. n°117

	ZCS/F1-SAT	Conf. Pz.
SCORRI QT BLOCC s/serratura SMART	66248724213	1
Square sliding door without lock		
SCORRI QT BLOCC c/serratura SMART	66248724813	1
Sliding door handle with lock		

⚡ Servizio G48: Articolo a magazzino e disponibile entro 48 dall'elaborazione dell'ordine. In base a disponibilita' e condizioni di vendita.  
G48 service: Item in stock and available within 48 hours of order processing. Based on availability and sales conditions.

# 5

**Alluminio galattico**

**Galactic Aluminum**

- 368 Maniglie + dk / Handles + dk
- 374 Maniglioni per alzanti scorrevoli / Pull handles for sliding door
- 375 Maniglie per porte scorrevoli / Sliding door handles
- 377 Maniglioni fissi / Pull handles

# 7900

Codice Maniglia

7900

Galactic Aluminium



MERCURY



SPACE



URANUS



JUPITER



MERCURY

Handles

	MERCURY	URANUS	JUPITER	SPACE	Conf. Pz.
1 Q8 RBQ 50x4 C/M Guarnitura Q8 ros./bocc. QUADRA patent con molla Lever handle 8mm on square rose key hole escutcheon springloaded	77900241833	77900241834	77900241841	77900241876	10
1 Q8 RBQY 50x4 C/M Guarnitura Q8 ros./bocc. QUADRA Yale con molla Lever handle 8mm on square rose cyl hole escutcheon springloaded	77900245833	77900245834	77900245841	77900245876	10
1 Q8 RBQWC Q6 50x4 C/M Guarnitura Q8 ros./bocc. QUADRA Wc Q6 con molla Lever handle 8mm on square rose wc hole escutcheon 6mm springloaded	77900248833	77900248834	77900248841	77900248876	10
2 DK40 BUS, 9,5 7900 GHTEK DK40 BUS. 9,5 window handle DK x 40mm with pins D.9,5	77900583033	77900583034	77900583041	77900583076	20
2 DK45 BUS, 9,5 c/viti 7900 GHTEK DK45 BUS. 9,5 c/viti window handle DK x 45mm with pins D.9,5 and screws	7790058333391	7790058333491	7790058334191	7790058337691	20

⚡ Servizio G48: Articolo a magazzino e disponibile entro 48 dall'elaborazione dell'ordine. In base a disponibilita' e condizioni di vendita.  
G48 service: Item in stock and available within 48 hours of order processing. Based on availability and sales conditions.

## PORTA

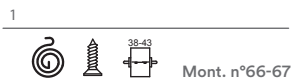
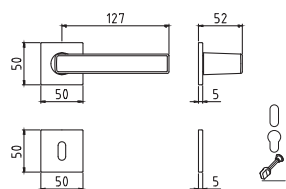

## FINESTRA

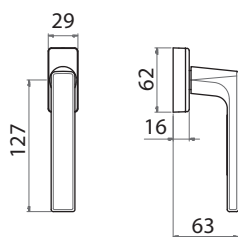

Per istruzioni di montaggio  
scansiona QR code,  
seleziona il numero di  
riferimento e segui le  
istruzioni.  
For assembly instructions  
scan the QR code, select the  
relevant assembly number  
and follow the instructions.

# 141

Codice Maniglia

141

Galactic Aluminum



MERCURY



SPACE



URANUS



JUPITER



Handles

URANUS

	MERCURY	URANUS	JUPITER	SPACE	Conf. Pz.
1 Q8 RBQ 50x4 C/M Guarnitura Q8 ros./bocc. QUADRA patent con molla Lever handle 8mm on square rose key hole escutcheon springloaded	70141241733	70141241734	70141241741	70141241776	1
1 Q8 RBQY 50x4 C/M Guarnitura Q8 ros./bocc. QUADRA Yale con molla Lever handle 8mm on square rose cyl hole escutcheon springloaded	70141245733	70141245734	70141245741	70141245776	1
1 Q8 RBQWC Q6 50x4 C/M Guarnitura Q8 ros./bocc. QUADRA Wc Q6 con molla Lever handle 8mm on square rose wc hole escutcheon 6mm springloaded	70141248733	70141248734	70141248741	70141248776	1
2 DK x 40 C/BUSS D.9,5 141 DKx40 C/BUSS D.9,5 window handle DK x 40 mm with pins D.9,5	7014155803395	7014155803495	7014155804195	7014155807695	2
2 DK x 45 C/BUSS D.9,5 C/viti 141 DKx45 C/BUSS D.9,5 C/viti window handle DK x 45 mm with pins D.9,5 with screws	7014155843395	7014155843495	7014155844195	7014155847695	2

⚡ Servizio G48: Articolo a magazzino e disponibile entro 48 dall'elaborazione dell'ordine. In base a disponibilita' e condizioni di vendita.  
G48 service: Item in stock and available within 48 hours of order processing. Based on availability and sales conditions.

## PORTA

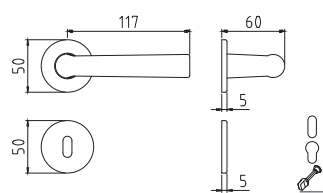

1

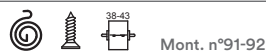

## FINESTRA

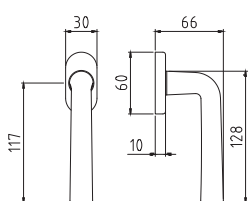

2



Per istruzioni di montaggio  
scansiona QR code,  
seleziona il numero di  
riferimento e segui le  
istruzioni.  
For assembly instructions  
scan the QR code, select the  
relevant assembly number  
and follow the instructions.



# 7900



## FINESTRA

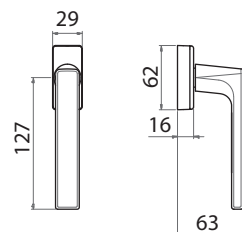

	MERCURY	URANUS	JUPITER	SPACE	Conf. Pz.
DK40 BUS, 9,5 7900 GHTEK DK40 BUS. 9,5 window handle DK x 40mm with pins D.9,5	77900583033	77900583034	77900583041	77900583076	20
DK45 BUS, 9,5 c/viti 7900 GHTEK DK45 BUS. 9,5 c/viti window handle DK x 45mm with pins D.9,5 and screws	7790058333391	7790058333491	7790058334191	7790058337691	20

⚡ Servizio G48: Articolo a magazzino e disponibile entro 48 dall'elaborazione dell'ordine. In base a disponibilita' e condizioni di vendita.  
G48 service: Item in stock and available within 48 hours of order processing. Based on availability and sales conditions.



Per istruzioni di montaggio  
scansiona QR code,  
seleziona il numero di  
riferimento e segui le  
istruzioni.  
For assembly instructions  
scan the QR code, select the  
relevant assembly number  
and follow the instructions.



FINESTRA

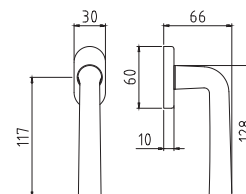



Mont. n°4

	MERCURY	URANUS	JUPITER	SPACE	Conf. Pz.
DK x 40 C/BUSS D.9,5 141 DKx40 C/BUSS D.9,5 window handle DK x 40 mm with pins D.9,5	7014155803395	7014155803495	7014155804195	7014155807695	2
DK x 45 C/BUSS D.9,5 C/viti 141 DKx45 C/BUSS D.9,5 C/viti window handle DK x 45 mm with pins D.9,5 with screws	7014155843395	7014155843495	7014155844195	7014155847695	2

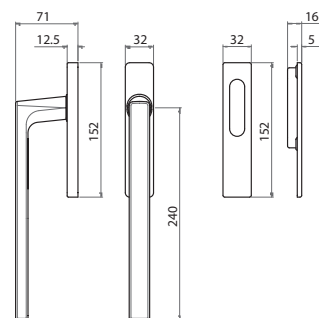

Per istruzioni di montaggio  
scansiona QR code,  
seleziona il numero di  
riferimento e segui le  
istruzioni.  
For assembly instructions  
scan the QR code, select the  
relevant assembly number  
and follow the instructions.

## 7900



	MERCURY	URANUS	JUPITER	SPACE	Conf. Pz.
SCATTO MAN PC CONCH.	77900601033	77900601034	77900601041	77900601076	1
Maniglione a scatto placca chiusa con conchiglia	⚡	⚡	⚡	⚡	
Pull handle for sliding door - closed plate					

⚡ Servizio G48: Articolo a magazzino e disponibile entro 48 dall'elaborazione dell'ordine. In base a disponibilita' e condizioni di vendita.  
G48 service: Item in stock and available within 48 hours of order processing. Based on availability and sales conditions.

# SCORRI TONDO CIECO

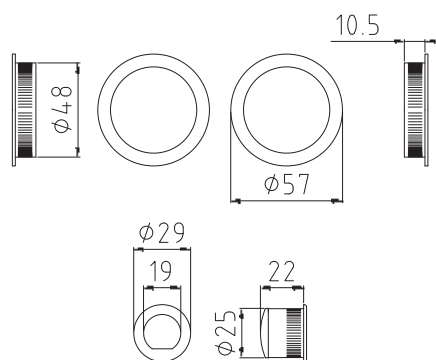

Mont. n°123

	MERCURY	URANUS	JUPITER	SPACE	Conf. Pz.
SCORRI TONDO CIECO	7704871613390	7704871613490	7704871614190	7704871617690	4
Square sliding door	⚡	⚡	⚡	⚡	

⚡ Servizio G48: Articolo a magazzino e disponibile entro 48 dall'elaborazione dell'ordine. In base a disponibilità e condizioni di vendita.  
G48 service: Item in stock and available within 48 hours of order processing. Based on availability and sales conditions.

# SCORRI TONDO BLOCC S/SERRATURA

ALLUMINIO GALATTICO

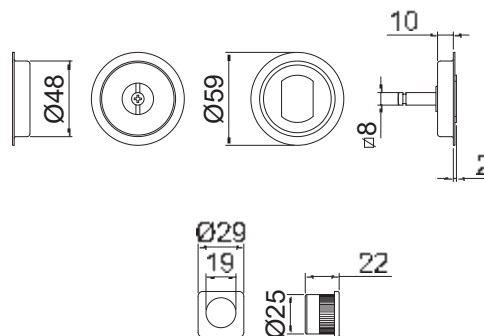

Mont. n°122

	MERCURY	URANUS	JUPITER	SPACE	Conf. Pz.
SCORRI TONDO BLOCC s/serratura	7704871913390	7704871913490	7704871914190	7704871917690	1
Slidding door handle without lock	⚡	⚡	⚡	⚡	

⚡ Servizio G48: Articolo a magazzino e disponibile entro 48 dall'elaborazione dell'ordine. In base a disponibilità e condizioni di vendita.  
G48 service: Item in stock and available within 48 hours of order processing. Based on availability and sales conditions.



Per istruzioni di montaggio scansiona QR code, seleziona il numero di riferimento e segui le istruzioni.  
For assembly instructions scan the QR code, select the relevant assembly number and follow the instructions.

# SCORRI QT CIECO

ALLUMINIO GALATTICO

10.5

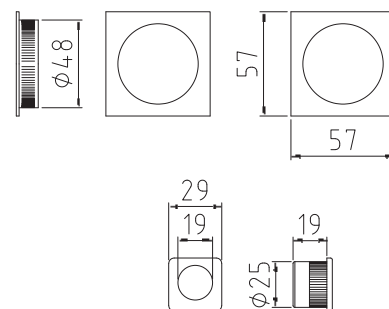

Mont. n°120

	MERCURY	URANUS	JUPITER	SPACE	Conf. Pz.
SCORRI QT CIECO	7704872463390	7704872463490	7704872464190	7704872467690	4
Square sliding door handle	⚡	⚡	⚡	⚡	

⚡ Servizio G48: Articolo a magazzino e disponibile entro 48 dall'elaborazione dell'ordine. In base a disponibilita' e condizioni di vendita.  
G48 service: Item in stock and available within 48 hours of order processing. Based on availability and sales conditions.

# SCORRI QT BLOCC S/SERRATURA

ALLUMINIO GALATTICO

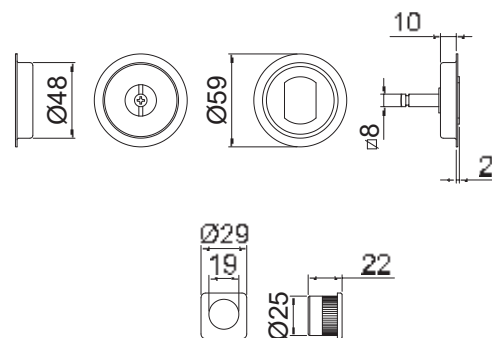
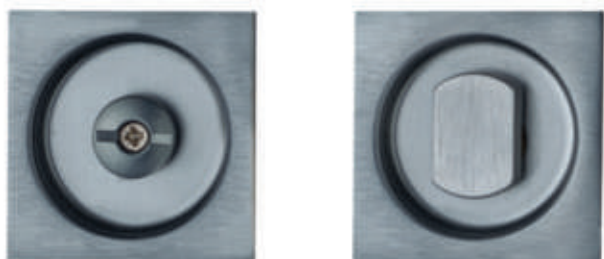

Mont. n°117

	MERCURY	URANUS	JUPITER	SPACE	Conf. Pz.
SCORRI QT BLOCC s/serratura	7704872413390	7704872413490	7704872414190	7704872417690	1
Square sliding door handle without lock	⚡	⚡	⚡	⚡	

⚡ Servizio G48: Articolo a magazzino e disponibile entro 48 dall'elaborazione dell'ordine. In base a disponibilita' e condizioni di vendita.  
G48 service: Item in stock and available within 48 hours of order processing. Based on availability and sales conditions.



Per istruzioni di montaggio scansiona QR code, seleziona il numero di riferimento e segui le istruzioni.  
For assembly instructions scan the QR code, select the relevant assembly number and follow the instructions.

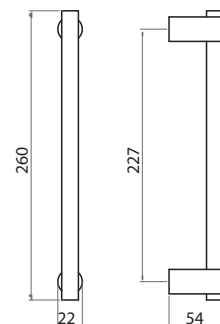

	MERCURY	URANUS	JUPITER	SPACE	Conf. Pz.
MAN DIR Maniglione diritto Straight pull handle	77056600233	77056600234	77056600241	77056600276	1

⚡ Servizio G48: Articolo a magazzino e disponibile entro 48 dall'elaborazione dell'ordine. In base a disponibilita' e condizioni di vendita.  
G48 service: Item in stock and available within 48 hours of order processing. Based on availability and sales conditions.

# 7900

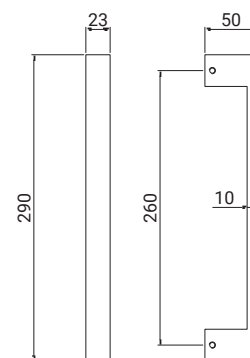

	MERCURY	URANUS	JUPITER	SPACE	Conf. Pz.
MAN DIR Maniglione diritto Straight pull handle	77900600233	77900600234	77900600241	77900600276	1

# 6

**Articoli smart**

**Smart products**

380 Maniglie + dk / Handles + dk  
403 Maniglie per porte scorrevoli / Sliding door handles



# GM05

ZAMA



ZCS



ZGV



ZCL



ZOS



GCTOL

	ZCS	ZCS/F1-SAT	ZCS/F1-SAT/GSH	GCTOL	GCTOL/GSH	ZCL	ZGV	Conf. Pz.
1 Q8 R Guarnitura Q8 ros. senza bocc. Lever handle 8mm on rose		6GM59280013		6GM58280012		6GM58280007	6GM58280004	1
1 Q8 RB Guarnitura Q8 ros./bocc. patent Lever handle 8mm on rose key hole escutcheon		6GM59281013	6GM59281013S	6GM58281012	6GM58281012S	6GM58281007	6GM58281004	1
1 Q8 RBY Guarnitura Q8 ros./bocc. yale Lever handle 8mm on rose - cyl. hole escutcheon		6GM59285013	6GM59285013S	6GM58285012	6GM58285012S	6GM58285007	6GM58285004	1
1 Q8 RBWC Guarnitura Q8 ros./bocc. Wc Lever handle 8mm on rose wc hole escutcheon		6GM59288013		6GM58288012		6GM58288007	6GM58288004	1
2 Q8 ROC Guarnitura Q8 ros.ovale senza bocc. Lever handle 8mm on oval rose	6GM58220513			6GM58220512		6GM58220507	6GM58220504	1
2 Q8 RBOC Guarnitura Q8 ros/boc. ovale patent Lever handle 8mm on oval rose key hole escutcheon	6GM58221513			6GM58221512		6GM58221507	6GM58221504	1
2 Q8 RBOYC Guarnitura Q8 ros/boc. ovale Yale Lever handle 8mm on oval rose - cyl. hole escutcheon	6GM58225513			6GM58225512		6GM58225507	6GM58225504	1
3 DK X 40 Martellina DK Q7 x 40 window handle DK x 40 mm	6GM58557013			6GM58557012		6GM58557007	6GM58557004	2
3 DK X 40 C/BUSS. Martellina DK Q7 x 40 con bussole D. 9,5 window handle DK x 40mm with pins D.9,5	6GM58558013			6GM58558012		6GM58558007	6GM58558004	2

⚡ Servizio G48: Articolo a magazzino e disponibile entro 48 dall'elaborazione dell'ordine. In base a disponibilita' e condizioni di vendita.  
G48 service: Item in stock and available within 48 hours of order processing. Based on availability and sales conditions.

## PORTA

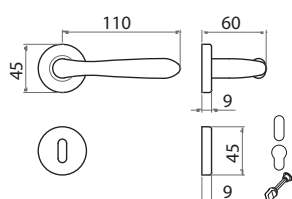

1 Ros 45x9



Mont. n°88-89

## FINESTRA

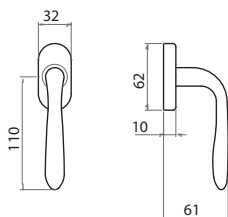

3



Mont. n°8

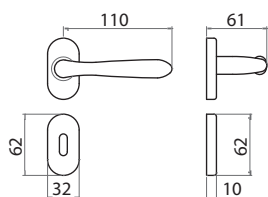

2



Mont. n°25



Per istruzioni di montaggio  
scansiona QR code,  
seleziona il numero di  
riferimento e segui le  
istruzioni.  
For assembly instructions  
scan the QR code, select the  
relevant assembly number  
and follow the instructions.

# GM08

ZAMA



ZCL



ZCS

	ZCS	ZCS/F1-SAT	ZCS/GSH	ZCL	Conf. Pz.
1 Q8 RQ Guarnitura Q8 ros. senza bocc. Lever handle 8mm on rose		6GM08240313		6GM08240007	1
1 Q8 RBQ Guarnitura Q8 ros./bocc. patent Lever handle 8mm on rose key hole escutcheon		6GM08241313	6GM08241013S	6GM08241007	1
1 Q8 RBQY Guarnitura Q8 ros./bocc. yale Lever handle 8mm on rose - cyl. hole escutcheon		6GM08245313	6GM08245013S	6GM08245007	1
1 Q8 RBQWC Guarnitura Q8 ros./bocc. Wc Lever handle 8mm on rose wc hole escutcheon		6GM08248313	6GM08248013S	6GM08248007	1
2 Q8 RRC guarnitura rosetta rettangolare Q8 C/M molla dx/sx Lever handle 8mm on springloaded rectangular rose	6GM08210413			6GM08210407	1
2 Q8 RBR Guarnitura Q8 ros./bocc. rett. patent molla dx/sx Lever handle 8mm on springloaded rect rose key hole esc	6GM08211413			6GM08211407	1
2 Q8 RBYR Guarnitura Q8 ros./bocc. rett.yale molla dx/sx Lever handle 8mm on springloaded rect rose - cyl. hole esc	6GM08215413			6GM08215407	1
3 DK X 40 Martellina DK Q7 x 40 window handle DK x 40 mm	6GM08555013			6GM08555007	2
3 DK X 40 C/BUSS. Martellina DK Q7 x 40 con bussole D. 9,5 window handle DK x 40mm with pins D.9,5	6GM08556013			6GM08556007	2

⚡ Servizio G48: Articolo a magazzino e disponibile entro 48 dall'elaborazione dell'ordine. In base a disponibilita' e condizioni di vendita.  
G48 service: Item in stock and available within 48 hours of order processing. Based on availability and sales conditions.

## PORTA

## FINESTRA

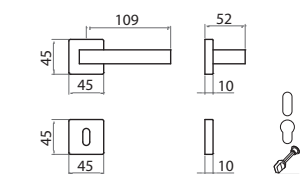

1 Ros 45x45

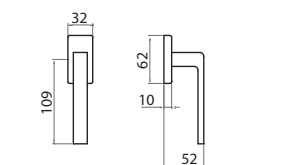
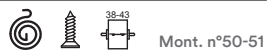

3

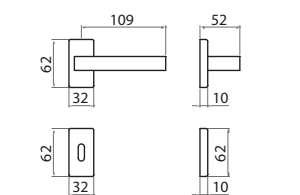

2

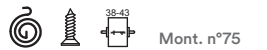

Per istruzioni di montaggio  
scansiona QR code,  
seleziona il numero di  
riferimento e segui le  
istruzioni.  
For assembly instructions  
scan the QR code, select the  
relevant assembly number  
and follow the instructions.

# GM11

ZAMA



Smart products



ZCL



ZCS

	ZCS	ZCS-MET	ZCS-GSH	ZCL	ZNO	Conf. Pz.
1 Q8 RQ Guarnitura Q8 ros. senza bocc. Lever handle 8mm on rose		6GM11240313		6GM11240507	6GM11240516	1
1 Q8 RBQ Guarnitura Q8 ros./bocc. patent Lever handle 8mm on rose key hole escutcheon		6GM11241313	6GM11241513S	6GM11241507	6GM11241516	1
1 Q8 RBQY Guarnitura Q8 ros./bocc. yale Lever handle 8mm on rose - cyl. hole escutcheon		6GM11245313	6GM11245513S	6GM11245507	6GM11245516	1
1 Q8 RBQWC Guarnitura Q8 ros./bocc. Wc Lever handle 8mm on rose wc hole escutcheon		6GM11248313	6GM11248013S	6GM11248007		1
2 Q8 RBR Guarnitura Q8 ros./bocc. rett. patent molla dx/sx Lever handle 8mm on springloaded rect rose key hole esc	6GM11211413			6GM11211407		1
2 Q8 RBYR Guarnitura Q8 ros./bocc. rett.yale molla dx/sx Lever handle 8mm on springloaded rect rose - cyl. hole esc	6GM11215413			6GM11215407		1
3 DK X 40 C/BUSS. Martellina DK Q7 x 40 con bussole D. 9,5 window handle DK x 40mm with pins D.9,5	6GM11553813			6GM11553807		2

⚡ Servizio G48: Articolo a magazzino e disponibile entro 48 dall'elaborazione dell'ordine. In base a disponibilita' e condizioni di vendita.  
G48 service: Item in stock and available within 48 hours of order processing. Based on availability and sales conditions.

## PORTA

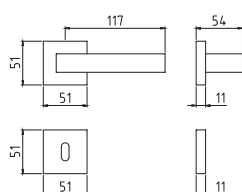

1 Ros 50x50x4



Mont. n°57-58

## FINESTRA

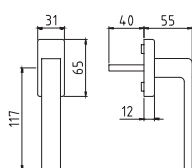

3 - - - -



Mont. n°6

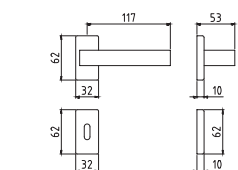

2 0006



Mont. n°75



Per istruzioni di montaggio  
scansiona QR code,  
seleziona il numero di  
riferimento e segui le  
istruzioni.  
For assembly instructions  
scan the QR code, select the  
relevant assembly number  
and follow the instructions.

# MILENA Z

ZAMA



ZCL



ZCS



GCTOL



GCTOL

		ZCS	ZCS/F1-SAT	GCTOL	ZCL	Conf. Pz.
1	Q8 P90 Guarnitura Q8 placca patent 90 Lever handle 8mm on key plate 90	66744089013		66744089012	66744089007	1
1	Q8 P70 Guarnitura Q8 placca patent 70 Lever handle 8mm on key plate 70	66744087013		66744087012	66744087007	1
1	Q8 PY85 Guarnitura Q8 placca yale 85 Lever handle 8mm on cyl. plate 85	66744088513		66744088512	66744088507	1
2	Q8 R Guarnitura Q8 ros. senza bocc. Lever handle 8mm on rose	66744280513	66746280513	66744280512	66744280507	1
2	Q8 RB Guarnitura Q8 ros./bocc. patent Lever handle 8mm on rose key hole escutcheon	66744281513	66746281513	66744281512	66744281507	1
2	Q8 RBY Guarnitura Q8 ros./bocc. yale Lever handle 8mm on rose - cyl. hole escutcheon	66744285513	66746285513	66744285512	66744285507	1
2	Q8 RBWC Guarnitura Q8 ros./bocc. Wc Lever handle 8mm on rose wc hole escutcheon	66744288013	66746288513	66744288012	66744288007	1
3	DK X 40 Martellina DK Q7 x 40 window handle DK x 40 mm	66744557013		66744557012	66744557007	2
3	DK X 40 C/BUSS. Martellina DK Q7 x 40 con bussole D. 9,5 window handle DK x 40mm with pins D.9,5	66744558013		66744558012	66744558007	2

⚡ Servizio G48: Articolo a magazzino e disponibile entro 48 dall'elaborazione dell'ordine. In base a disponibilita' e condizioni di vendita.  
G48 service: Item in stock and available within 48 hours of order processing. Based on availability and sales conditions.

## PORTA

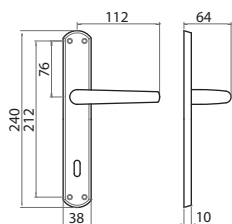

1 Placca MILENA

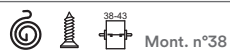

## FINESTRA

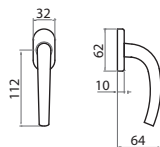

3

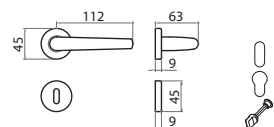

2 Ros 45x9

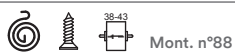

Per istruzioni di montaggio  
scansiona QR code,  
seleziona il numero di  
riferimento e segui le  
istruzioni.  
For assembly instructions  
scan the QR code, select the  
relevant assembly number  
and follow the instructions.



# 142

ALLUMINIO



F1



F4



# BRIXIA

ALLUMINIO



F1



F4



F9



F1



F1

	F1	F3	F4	F9	Conf. Pz.
1 Q8 BIL Coppia maniglie con Q8 (Bilancino) Pair handle with 8mm spindle	77438208001	77438208003	77438208004	77438208009	10
2 Q8 P90 Guarnitura Q8 placca patent 90 Lever handle 8mm on key plate 90	77438089001	77438089003	77438089004	77438089009	10
2 Q8 P70 Guarnitura Q8 placca patent 70 Lever handle 8mm on key plate 70	77438087001	77438087003	77438087004	77438087009	10
2 Q8 PY85 Guarnitura Q8 placca yale 85 Lever handle 8mm on cyl. plate 85	77438088501	77438088503	77438088504	77438088509	10
3 Q8 R 45 Guarnitura Q8 ros. senza bocc. Lever handle 8mm on rose	77438280001	77438280003	77438280004	77438280009	10
3 Q8 RB 45 Guarnitura Q8 ros./bocc. patent Lever handle 8mm on rose key hole escutcheon	77438281001	77438281003	77438281004	77438281009	10
3 Q8 RBY 45 Guarnitura Q8 ros./bocc. yale Lever handle 8mm on rose - cyl. hole escutcheon	77438285001	77438285003	77438285004	77438285009	10
4 Q8 R 50 Guarnitura Q8 ros. senza bocc. Lever handle 8mm on rose	77438230001	77438230003	77438230004	77438230009	10
4 Q8 RB 50 Guarnitura Q8 ros./bocc. patent Lever handle 8mm on rose key hole escutcheon	77438231001	77438231003	77438231004	77438231009	10
4 Q8 RBY 50 Guarnitura Q8 ros./bocc. yale Lever handle 8mm on rose - cyl. hole escutcheon	77438235001	77438235003	77438235004	77438235009	10
5 Q8 RBWC Q6 50 Guarnitura Q8 ros./bocc. Wc Q6 Lever handle 8mm on wc key hole escutcheon 6mm	77438238001	77438238003	77438238004	77438238009	10
5 DKx33 8SC BUS. 9,5 BRIXIA DKx33 8SC BUS. 9,5 window handle DK x 33mm with pins D.9,5	7743855830158	7743855830358	7743855830458	7743855830958	100
6 DKx35 8SC BUS. 9,5 BRIXIA DKx35 8SC BUS. 9,5 window handle DK x 35mm with pins D.9,5	7743855850158	7743855850358	7743855850458	7743855850958	100
6 DKx40 8SC BUS. 9,5 BRIXIA DKx40 8SC BUS. 9,5 window handle DK x 40mm with pins D.9,5	7743855800158	7743855800358	7743855800458	7743855800958	100
6 DKx45 8SC BUS. 9,5 BRIXIA DKx45 8SC BUS. 9,5 window handle DK x 45mm with pins D.9,5	7743855840158	7743855840358	7743855840458	7743855840958	100
7 BALCONY DOOR G.ra ros bocc yale per porta balcone Q7 - viti pass Lever handle 7mm on rect rose key hole esc. metric-thread screw	77438227301	77438227303	77438227304	77438227309	

## PORTA

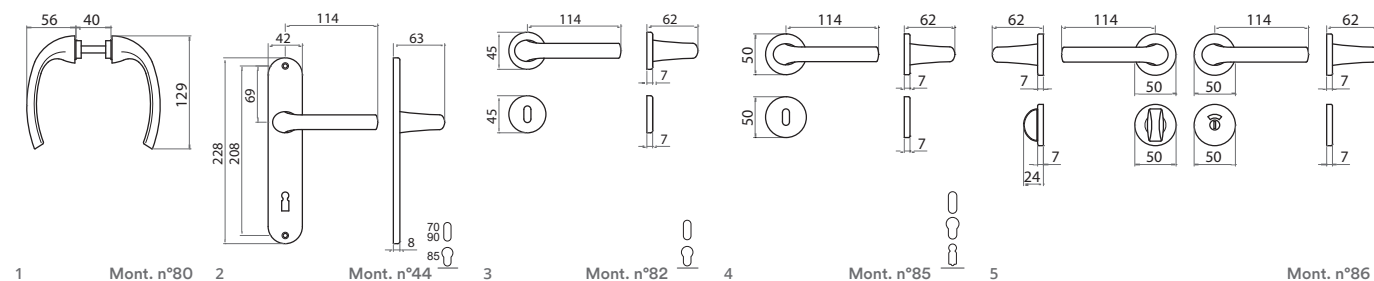

  Guarnitura senza molla di ritorno - Handle without spring  
Viti non in dotazione - Screws not provided

## FINESTRA

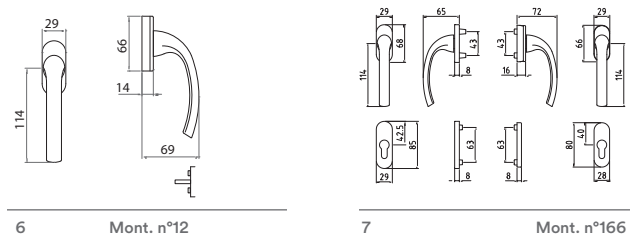

Per istruzioni di montaggio  
scansiona QR code,  
seleziona il numero di  
riferimento e segui le  
istruzioni.  
For assembly instructions  
scan the QR code, select the  
relevant assembly number  
and follow the instructions.

# CARLO

ALLUMINIO



F1



F4



F9



BIANCO/WHITE



NERO/BLACK



F4



F4



F4



F1



Per istruzioni di montaggio  
scansiona QR code,  
seleziona il numero di  
riferimento e segui le  
istruzioni.  
For assembly instructions  
scan the QR code, select the  
relevant assembly number  
and follow the instructions.

	F1	F4	F9	ANO	RAL9016	Conf. Pz.
1 Q8 BIL Coppia maniglie con Q8 (Bilancino) Pair handle with 8mm spindle	77502208001	77502208004	77502208009	77502208016	77502208080	10
2 Q8 RQ 45X45X10 Guarnitura Q8 ros. QUADRA senza bocc. Lever handle 8mm on square rose	77502240001	77502240004	77502240009	77502240016	77502240080	10
2 Q8 RQ 45X45X10 C/M Guarnitura Q8 ros. QUADRA senza bocc. con molla Lever handle 8mm on square rose springloaded	77502240501	77502240504	77502240509	77502240516	77502240580	10
2 Q8 RBQ 45X45X10 Guarnitura Q8 ros./bocc. QUADRA patent Lever handle 8mm on square rose key hole escutcheon	77502241001	77502241004	77502241009	77502241016	77502241080	10
2 Q8 RBQ 45X45X10 C/M Guarnitura Q8 ros./bocc. QUADRA patent con molla Lever handle 8mm on square rose key hole escutcheon springloaded	77502241501	77502241504	77502241509	77502241516	77502241580	10
2 Q8 RBQY 45X45X10 Guarnitura Q8 ros./bocc. QUADRA Yale Lever handle 8mm on square rose cyl hole escutcheon	77502245001	77502245004	77502245009	77502245016	77502245080	10
2 Q8 RBQY 45X45X10 C/M Guarnitura Q8 ros./bocc. QUADRA Yale con molla Lever handle 8mm on square rose cyl hole escutcheon springloaded	77502245501	77502245504	77502245509	77502245516	77502245580	10
3 Q8 RBR Guarnitura Q8 ros./bocc. RETT. patent Lever handle 8mm on springloaded rect rose key hole esc	77502281401	77502281404	77502281409	77502281416	77502281480	10
3 Q8 RBYR Guarnitura Q8 ros./bocc. rett.yale molla dx/sx Lever handle 8mm on springloaded rect rose - cyl. hole esc	77502285401	77502285404	77502285409	77502285416	77502285480	10
4 Q8 RBQWC Q6 45X45X10 Guarnitura Q8 ros./bocc. QUADRA Wc Q6 Lever handle 8mm on square rose wc hole escutcheon 6mm	77502248001	77502248004	77502248009	77502248016	77502248080	10
4 Q8 RBQWC Q6 45X45X10 C/M Guarnitura Q8 ros./bocc. QUADRA Wc Q6 con molla Lever handle 8mm on square rose wc hole escutcheon 6mm springloaded	77502248501	77502248504	77502248509	77502248516	77502248580	10
5 DK X 35 C/BUSS D.9,5 CARLO DKX35 8SC RET BUS.9,5 window handle DK x 35mm with pins D.9,5	7750255650108	7750255650408	7750255650908	7750255651608	7750255658008	100
5 DK X 40 C/BUSS D.9,5 CARLO DK Q7 x 40 con bussole D. 9,5 window handle DK x 40mm with pins D.9,5	7750255600108	7750255600408	7750255600908	7750255601608	7750255608008	20
5 DK X 45 C/BUSS D.9,5 CARLO DKX45 8SC RET BUS.9,5 window handle DK x 45mm with pins D.9,5	7750255640108	7750255640408	7750255640908	7750255641608	7750255648008	100
5 DK X 50 C/BUSS D.9,5 CARLO DKX50 8SC RET BUS.9,5 window handle DK x 50mm with pins D.9,5	7750255660108	7750255660408	7750255660908	7750255661608	7750255668008	100
6 DK X 40 C/BUSS D.9,5 CARLO con pulsante DK Q7 x 40 con bussole D. 9,5 window handle DK x 40mm with pins D.9,5	77502562501	77502562504	77502562509	77502562516	77502562580	5
7 DK X 45 C/BUSS D.9,5 CARLO con chiave DK Q7 x 45 con bussole D. 9,5 window handle DK x 45mm with pins D.9,5	77502563301	77502563304	77502563309	77502563316	77502563380	5
7 DK X 40 C/BUSS D.9,5 CARLO con chiave DK Q7 x 40 con bussole D. 9,5 window handle DK x 40mm with pins D.9,5	77502563501	77502563504	77502563509	77502563516	77502563580	5
8 BALCONY DOOR G.ra ros bocc yale per porta balcone Q7 - viti pass Lever handle 7mm on rect rose key hole esc metric-thread screw	77502217301	77502217304	77502217309	77502217316	77502217380	
9 BALCONY DOOR G.ra ros bocc yale per porta balcone Q7 - viti pass Lever handle 7mm on rect rose key hole esc metric-thread screw	77502217501	77502217504	77502217509	77502217516	77502217580	

## PORTA

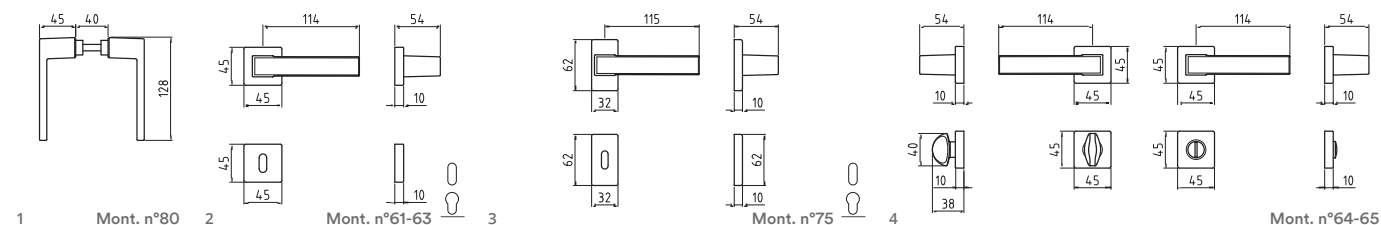

1 Mont. n°80

2 Mont. n°61-63

3

Mont. n°75

Mont. n°64-65



Guarnitura con molla di ritorno - Handle with spring  
Viti non in dotazione - Screws not provided

## FINESTRA

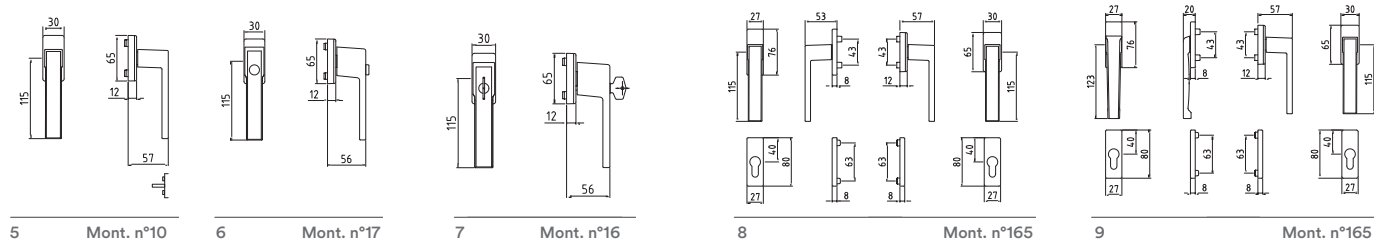

5 Mont. n°10

6 Mont. n°17

7

Mont. n°16

8

Mont. n°165

9

Mont. n°165

# GABRY

ALLUMINIO



F1



F4



F4





# GM05

ZAMA

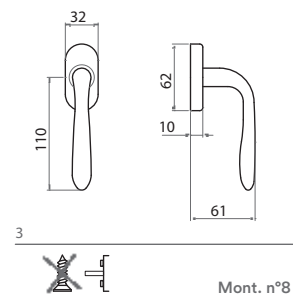

	ZGV	ZCL	GCTOL	ZCS	Conf. Pz.
3 DK X 40 Martellina DK Q7 x 40 window handle DK x 40 mm	6GM58557004	6GM58557007	6GM58557012	6GM58557013	2
3 DK X 40 C/BUSS. Martellina DK Q7 x 40 con bussole D. 9,5 window handle DK x 40mm with pins D.9,5	6GM58558004	6GM58558007	6GM58558012	6GM58558013	2



Per istruzioni di montaggio  
scansiona QR code,  
seleziona il numero di  
riferimento e segui le  
istruzioni.  
For assembly instructions  
scan the QR code, select the  
relevant assembly number  
and follow the instructions.

# GM08

ZAMA

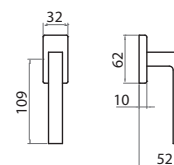

3



Mont. n°6

	ZCL	ZCS	Conf. Pz.
3 DK X 40 Martellina DK Q7 x 40 window handle DK x 40 mm	6GM08555007	6GM08555013	2
3 DK X 40 C/BUSS. Martellina DK Q7 x 40 con bussole D. 9,5 window handle DK x 40mm with pins D.9,5	6GM08556007	6GM08556013	2



Per istruzioni di montaggio  
scansiona QR code,  
seleziona il numero di  
riferimento e segui le  
istruzioni.  
For assembly instructions  
scan the QR code, select the  
relevant assembly number  
and follow the instructions.

# GM11

ZAMA

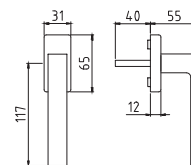

3



Mont. n°6

	ZCL	ZCS	Conf. Pz.
3 DK X 40 C/BUSS. Martellina DK Q7 x 40 con bussole D. 9,5 window handle DK x 40mm with pins D.9,5	6GM11553807	6GM11553813	2



Per istruzioni di montaggio  
scansiona QR code,  
seleziona il numero di  
riferimento e segui le  
istruzioni.  
For assembly instructions  
scan the QR code, select the  
relevant assembly number  
and follow the instructions.

# MILENA Z

ZAMA

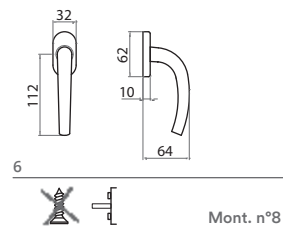

	ZCL	GCTOL	ZCS	Conf. Pz.
6 DK X 40 Martellina DK Q7 x 40 window handle DK x 40 mm	66744557007	66744557012	66744557013	2
6 DK X 40 C/BUSS. Martellina DK Q7 x 40 con bussole D. 9,5 window handle DK x 40mm with pins D.9,5	66744558007	66744558012	66744558013	2



Per istruzioni di montaggio  
scansiona QR code,  
seleziona il numero di  
riferimento e segui le  
istruzioni.  
For assembly instructions  
scan the QR code, select the  
relevant assembly number  
and follow the instructions.

# BRIXIA 2

ALLUMINIO

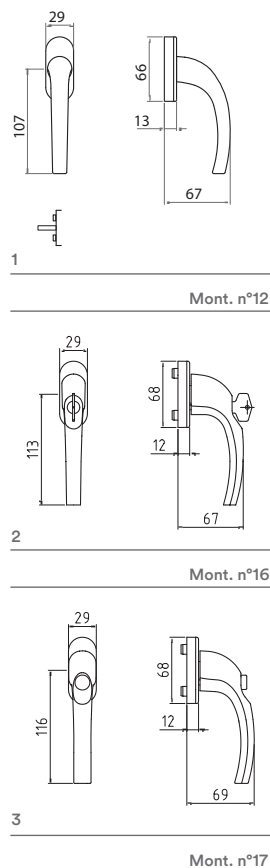

	F1	F3	F4	Conf. Pz.
1 DKx33 8SC BUS. 9,5 BRIXIA/2 DKx33 8SC BUS. 9,5 window handle DK x 33mm with pins D.9,5	7743355830158	7743355830358	7743355830458	100
1 DKx35 8SC BUS. 9,5 BRIXIA/2 DKx35 8SC BUS. 9,5 window handle DK x 35mm with pins D.9,5	7743355850158	7743355850358	7743355850458	100
1 DKx40 8SC BUS. 9,5 BRIXIA/2 DKx40 8SC BUS. 9,5 window handle DK x 40mm with pins D.9,5	7743355800158	7743355800358	7743355800458	100
1 DKx45 8SC BUS. 9,5 BRIXIA/2 DKx45 8SC BUS. 9,5 window handle DK x 45mm with pins D.9,5	7743355840158	7743355840358	7743355840458	100
2 DK X 40 C/BUSS D.9,5 BRIXIA/2 con chiave DK Q7 x 40 con bussole D. 9,5 window handle DK x 40mm with pins D.9,5	77433563501	77433563503	77433563504	5
3 DK X 40 C/BUSS D.9,5 BRIXIA/2 con pulsante DK Q7 x 40 con bussole D. 9,5 window handle DK x 40mm with pins D.9,5	77433562501	77433562503	77433562504	5

	RAL9010	RAL1013	ANO	RAL9016	Conf. Pz.
1 DKx33 8SC BUS. 9,5 BRIXIA/2 DKx33 8SC BUS. 9,5 window handle DK x 33mm with pins D.9,5	7743355830758	7743355831058	7743355831658	7743355838058	100
1 DKx35 8SC BUS. 9,5 BRIXIA/2 DKx35 8SC BUS. 9,5 window handle DK x 35mm with pins D.9,5	7743355850758	7743355851058	7743355851658	7743355858058	100
1 DKx40 8SC BUS. 9,5 BRIXIA/2 DKx40 8SC BUS. 9,5 window handle DK x 40mm with pins D.9,5	7743355800758	7743355801058	7743355801658	7743355808058	100
1 DKx45 8SC BUS. 9,5 BRIXIA/2 DKx45 8SC BUS. 9,5 window handle DK x 45mm with pins D.9,5	7743355840758	7743355841058	7743355841658	7743355848058	100
2 DK X 40 C/BUSS D.9,5 BRIXIA/2 con chiave DK Q7 x 40 con bussole D. 9,5 window handle DK x 40mm with pins D.9,5	77433563607	77433563510	77433563516	77433563580	5
3 DK X 40 C/BUSS D.9,5 BRIXIA/2 con pulsante DK Q7 x 40 con bussole D. 9,5 window handle DK x 40mm with pins D.9,5	77433562507	77433562510	77433562516	77433562580	5

# CARLO

ALLUMINIO

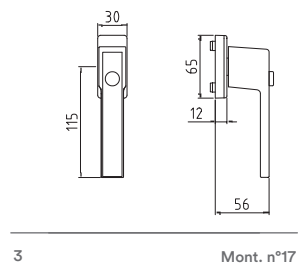
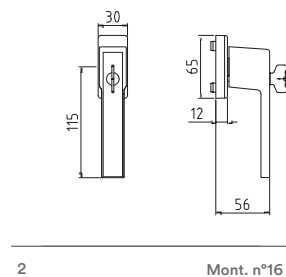
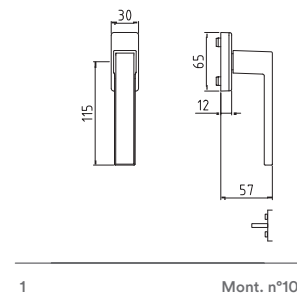

	F1	F3	F4	F9	Conf. Pz.
1 DK X 35 C/BUSS D.9,5	7750255650108	7750255650308	7750255650408	7750255650908	100
1 CARLO DKX35 8SC RET BUS.9,5 window handle DK x 35mm with pins D.9,5					100
1 DK X 40 C/BUSS D.9,5	7750255600108	7750255600308	7750255600408	7750255600908	20
1 CARLO DK Q7 x 40 con bussole D. 9,5 window handle DK x 40mm with pins D.9,5					20
1 DK X 45 C/BUSS D.9,5	7750255640108	7750255640308	7750255640408	7750255640908	100
1 CARLO DKX45 8SC RET BUS.9,5 window handle DK x 45mm with pins D.9,5					100
1 DK X 50 C/BUSS D.9,5	7750255660108	7750255660308	7750255660408	7750255660908	100
1 CARLO DKX50 8SC RET BUS.9,5 window handle DK x 50mm with pins D.9,5					100
2 DK X 45 C/BUSS D.9,5	77502563301	77502563303	77502563304	77502563309	5
2 CARLO con chiave DK Q7 x 45 con bussole D. 9,5 window handle DK x 45mm with pins D.9,5					5
2 DK X 40 C/BUSS D.9,5	77502563501	77502563503	77502563504		5
3 CARLO con chiave DK Q7 x 40 con bussole D. 9,5 window handle DK x 40mm with pins D.9,5					5
3 DK X 40 C/BUSS D.9,5	77502562501	77502562503	77502562504	77502562509	5
3 CARLO con pulsante DK Q7 x 40 con bussole D. 9,5 window handle DK x 40mm with pins D.9,5					5
	RAL9010	RAL1013	ANO	RAL9016	Conf. Pz.
1 DK X 35 C/BUSS D.9,5	7750255650708	7750255651008	7750255651608	7750255658008	100
1 CARLO DKX35 8SC RET BUS.9,5 window handle DK x 35mm with pins D.9,5					100
1 DK X 40 C/BUSS D.9,5	7750255600708	7750255601008	7750255601608	7750255608008	20
1 CARLO DK Q7 x 40 con bussole D. 9,5 window handle DK x 40mm with pins D.9,5					20
1 DK X 45 C/BUSS D.9,5	7750255640708	7750255641008	7750255641608	7750255648008	100
1 CARLO DKX45 8SC RET BUS.9,5 window handle DK x 45mm with pins D.9,5					100
1 DK X 50 C/BUSS D.9,5	7750255660708	7750255661008	7750255661608	7750255668008	100
1 CARLO DKX50 8SC RET BUS.9,5 window handle DK x 50mm with pins D.9,5					100
2 DK X 45 C/BUSS D.9,5	77502563307	77502563310	77502563316	77502563380	5
2 CARLO con chiave DK Q7 x 45 con bussole D. 9,5 window handle DK x 45mm with pins D.9,5					5
2 DK X 40 C/BUSS D.9,5	77502563507	77502563510	77502563516	77502563580	5
3 CARLO con chiave DK Q7 x 40 con bussole D. 9,5 window handle DK x 40mm with pins D.9,5					5
3 DK X 40 C/BUSS D.9,5	77502562507	77502562510	77502562516	77502562580	5
3 CARLO con pulsante DK Q7 x 40 con bussole D. 9,5 window handle DK x 40mm with pins D.9,5					5

# GABRY

ALLUMINIO

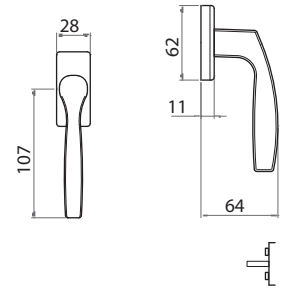

1

Mont. n°10

	F1	F3	F4	Conf. Pz.
1 DK X 33 C/BUSS D.9,5 GABRY TN DKx33 RETT BUS window handle DK x 33mm with pins D.9,5	7740055600158	7740055600358	7740055600458	100
1 DK X 35 C/BUSS D.9,5 GABRY TN DKx35 RETT BUS window handle DK x 35mm with pins D.9,5	7740055650158	7740055650358	7740055650458	100
1 DK X 40 C/BUSS D.9,5 GABRY TN DKx40 RETT BUS window handle DK x 40mm with pins D.9,5	7740055630158	7740055630358	7740055630458	100
1 DK X 45 C/BUSS D.9,5 GABRY TN DKx45 RETT BUS window handle DK x 45mm with pins D.9,5	7740055640158	7740055640358	7740055640458	100



Per istruzioni di montaggio  
scansiona QR code,  
seleziona il numero di  
riferimento e segui le  
istruzioni.  
For assembly instructions  
scan the QR code, select the  
relevant assembly number  
and follow the instructions.

# KIT SCORRI TONDO BLOCC C/SERR ECO

ZAMA

403

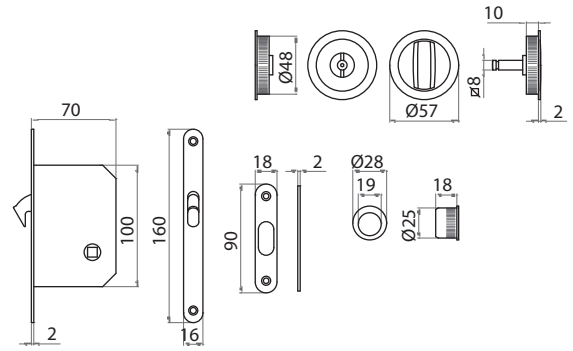
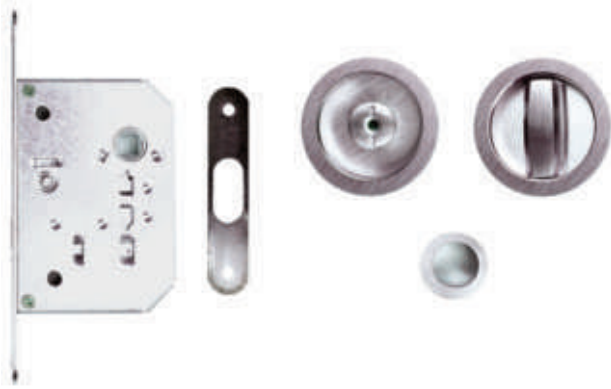

Mont. n°122

ADATTO PER SPESSORE PANNELLO mm 44, ± 1mm

	ZCL	GCTOL	ZCS	Conf. Pz.
KIT SCORRI TONDO BLOCC c/serratura eco	66048718807	66048718812	66048718813	1
Sliding door handle with lock				

# KIT SCORRI QT BLOCC SERR. ECO

ZAMA

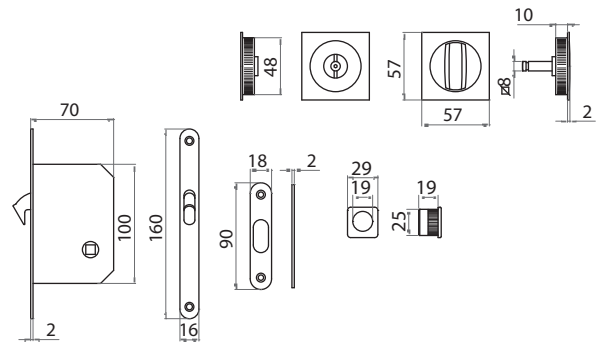
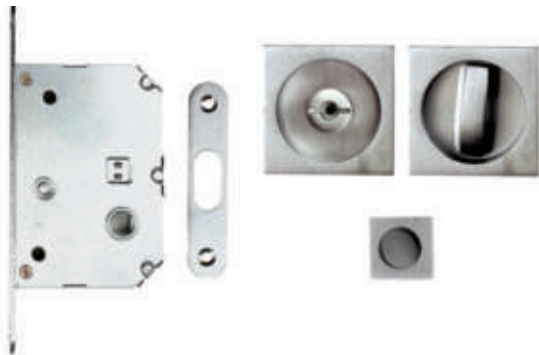

Mont. n°117

	ZCL	GCTOL	ZCS	Conf. Pz.
KIT SCORRI QT BLOCC c/serratura eco	66048724807	66048724812	66048724813	1
Square sliding door handle with lock				



Per istruzioni di montaggio scansiona QR code, seleziona il numero di riferimento e segui le istruzioni.  
For assembly instructions scan the QR code, select the relevant assembly number and follow the instructions.







# 7

**Porte d'ingresso**

**Entrance doors**

- 408 Pomoli / Knobs
- 415 Maniglioni fissi / Pull handles
- 420 Battenti / Boor knockers
- 422 Rosette, bocchette, placche per porte blindate /  
Accessories for armored doors
- 428 Maniglie singole / Single handles
- 430 Nottolini limitatori d'apertura per porte blindate  
Knobs for opening limiting device armored doors
- 433 Kit per porte basculanti  
Garage door handle kit



OLV

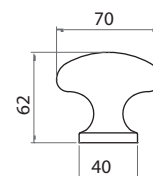

1

Mont. n°155

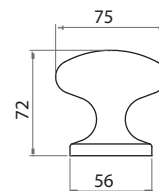

2

Mont. n°155

	OLV	OCS	OGV	OCL	OS	Conf. Pz.
1 POM 70 CP Pomolo mm 70 centroporta knob mm 70	5GM96770301	5GM96770303	5GM96770304	5GM96770307	5GM96770308	1
2 POM 75 CP Pomolo mm 75 centroporta knob mm 75	5GM96770501	5GM96770503	5GM96770504	5GM96770507	5GM96770508	1



Per istruzioni di montaggio  
scansiona QR code,  
seleziona il numero di  
riferimento e segui le  
istruzioni.  
For assembly instructions  
scan the QR code, select the  
relevant assembly number  
and follow the instructions.



OLV

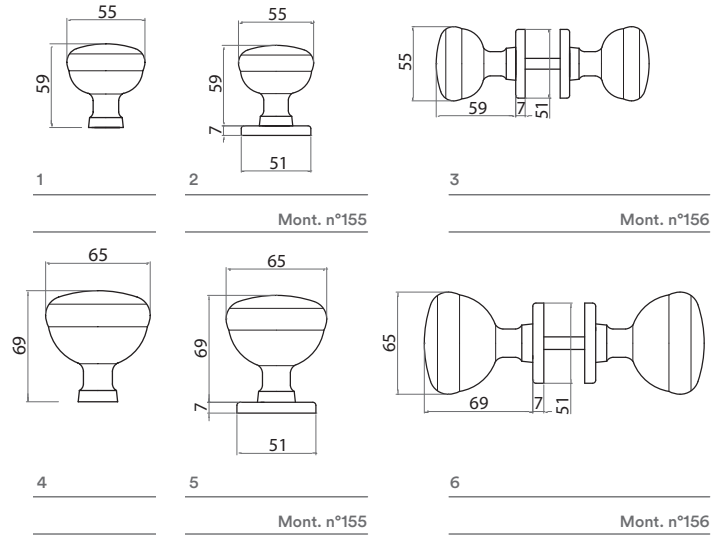

	OLV	OCS	OGV	OCL	OS	Conf. Pz.
1 POM55 M10/Q8 S/ROS Pomolo mm 55 fisso/girevole senza rosetta knob mm 55 fix/turnable w/o rose	55744855601	55744855603	55744855604	55744855607	55744855608	10
2 POM55 CP R51x7 Pomolo mm 55 centroporta rosetta 51x7 knob mm 55 on rose 51x7	55744755501	55744755503	55744755504	55744755507	55744755508	1
3 POM55 Q8CP R51x7 Pomoli mm 55 Q8 accoppiati rosetta 51x7 Pair of knobs D55 on rose 51x7mm	55744751001	55744751003	55744751004	55744751007	55744751008	1
4 POM70 M10/Q8 S/ROS Pomolo mm 70 fisso/girevole senza rosetta knob mm 70 fix/turnable w/o rose	55744875601	55744875603	55744875604	55744875607	55744875608	10
5 POM70 CP R51x7 Pomolo mm 70 centroporta rosetta 51x7 knob mm 70 on rose 51x7	55744770501	55744770503	55744770504	55744770507	55744770508	1
6 POM70 Q8CP R51x7 Pomoli mm 70 Q8 accoppiati rosetta 51x7 Pair of knobs D70 on rose 51x7mm	55744771001	55744771003	55744771004	55744771007	55744771008	1

# PEGASO



GCTOL

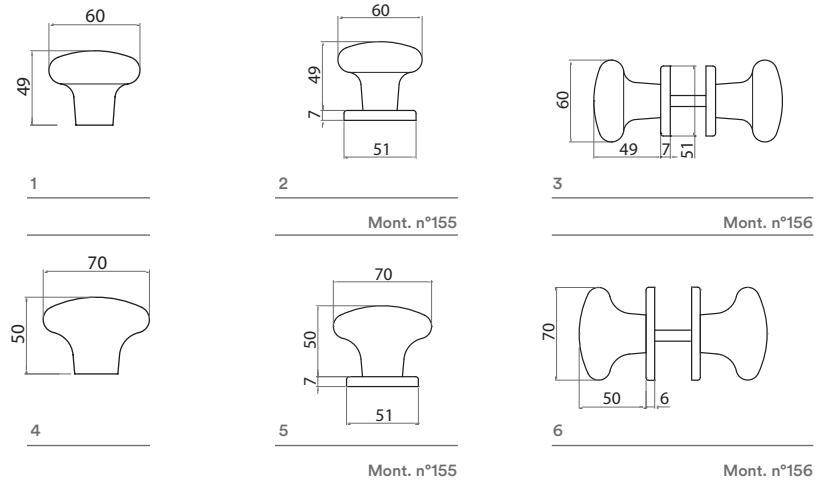

	OLV	OCS	OGV	OCL	OS	Conf. Pz.
1 POM60 M10/Q8 S/ROS PEGASO POM60 M10 Q8 knob mm 60 fix/turnable w/o rose	44890865601	44890865603	44890865604	44890865607	44890865608	10
2 POM60 CP R51x7 Pomolo mm 60 centroporta rosetta 51x7 knob mm 60 on rose 51x7	44890755501	44890755503	44890755504	44890755507	44890755508	1
3 POM60 Q8CP R51x7 Pomoli mm 60 Q8 accoppiati rosetta 51x7 Pair of knobs D60 on rose 51x7mm	44890751001	44890751003	44890751004	44890751007	44890751008	1
4 POM70 M10/Q8 S/ROS PEGASO POM70 M10 Q8 knob mm 70 fix/turnable w/o rose	44890875601	44890875603	44890875604	44890875607	44890875608	10
5 POM70 CP R51x7 Pomolo mm 70 centroporta rosetta 51x7 knob mm 70 on rose 51x7	44890770501	44890770503	44890770504	44890770507	44890770508	1
6 POM70 Q8CP R51x7 Pomoli mm 70 Q8 accoppiati rosetta 51x7 Pair of knobs D70 on rose 51x7mm	44890771001	44890771003	44890771004	44890771007	44890771008	1

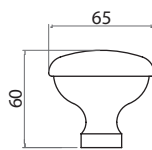

1

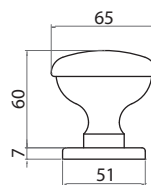

2

Mont. n°155

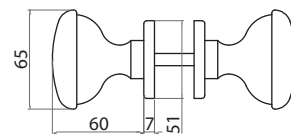

3

Mont. n°156

GCTOL

	OLV	OCS	OGV	OCL	OS	Conf. Pz.
1 POM65 M10/Q8 S/ROS BLINDO POM MM65 M10/Q8 knob mm 65 fix/turnable w/o rose	55694875601	55694875603	55694875604	55694875607	55694875608	10
2 POM65 CP R51x7 Pomolo mm 65 centroporta rosetta 51x7 knob mm 65 on rose 51x7	55694770501	55694770503	55694770504	55694770507	55694770508	1
3 POM65 Q8CP R51x7 Pomoli mm 65 Q8 accoppiati rosetta 51x7 Pair of knobs D65 on rose 51x7mm	55694771001	55694771003	55694771004	55694771007	55694771008	1

## YORK

ZAMA

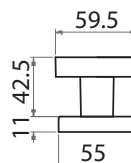

1

Mont. n°157

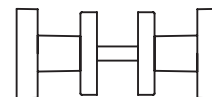

2

Mont. n°158

ZCS

	ZCL	ZCS	CHAMPAGNE	NORMANDIA	LORENA	BORGOGNA	Conf. Pz.
1 POM60 X60 CP R55X55 YORK POM60X60 CP R55x55 knob mm 60on rose 55x55	66460770207	66460770213	66460770243	66460770244	66460770246	66460770247	1
2 POM60X60 Q8CP R55x55 YORK POM60X60 Q8CP R55x55 pair of knobs mm 60X60 8mm rose 55X55	66460771007	66460771013	66460771043	66460771044	66460771046	66460771047	1



Per istruzioni di montaggio  
scansiona QR code,  
seleziona il numero di  
riferimento e segui le  
istruzioni.  
For assembly instructions  
scan the QR code, select the  
relevant assembly number  
and follow the instructions.

# UNIVERSAL

ALLUMINIO



F4

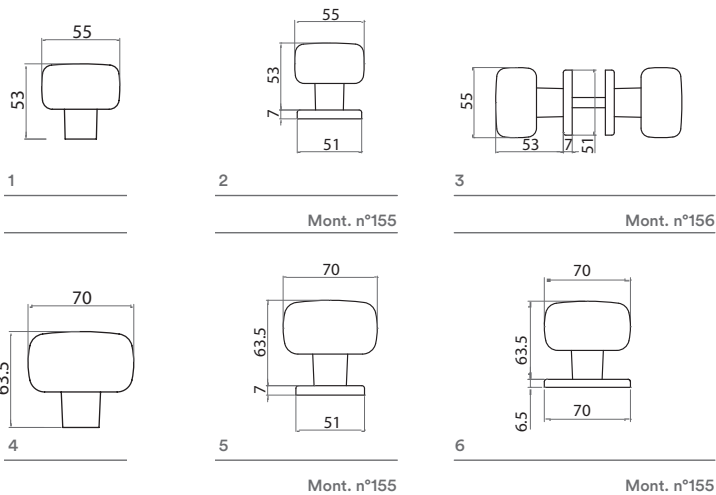

	F1	F4	GCTOL	GCTOS	GCTCL	GCTCS	Conf. Pz.
1 POM55 M10/Q8 S/ROS Pomolo mm 55 fisso/girevole senza rosetta knob mm 55 fix/turnable w/o rose	77486855601	77486855604	77486855612	77486855623	77486855624	77486855625	10
2 POM55 CP R51x7 Pomolo mm 55 centroporta rosetta 51x7 knob mm 55 on rose 51x7	77486755501	77486755504	77486755512	77486755523	77486755524	77486755525	1
3 POM55 Q8CP R51x7 Pomoli mm 55 Q8 accoppiati rosetta 51x7 Pair of knobs D55 on rose 51x7mm	77486751001	77486751004	77486751012	77486751023	77486751024	77486751025	1
4 POM70 M10/Q8 S/ROS Pomolo mm 70 fisso/girevole senza rosetta knob mm 70 fix/turnable w/o rose	77486875601	77486875604	77486875612	77486875623	77486875624	77486875625	10
5 POM70 CP R51x7 Pomolo mm 70 centroporta rosetta 51x7 knob mm 70 on rose 51x7	77486770501	77486770504	77486770512	77486770523	77486770524	77486770525	1
6 POM70 CP R70x6 Pomolo mm 70 centroporta rosetta 70x6 knob mm 70 on rose 70x6	7748687560107	7748687560407	7748687561207	7748687562307	7748687562407	7748687562507	1

# SUSY

ALLUMINIO



F4

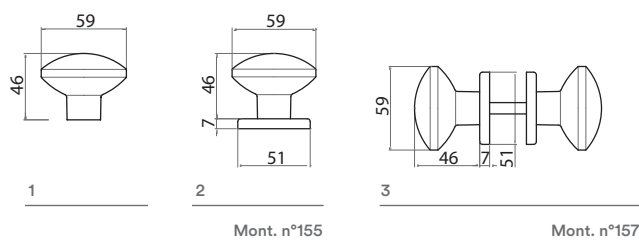

	F1	F4	GCTOL	GCTOS	GCTCL	GCTCS	Conf. Pz.
POM60 M10/Q8 S/ROS Pomolo mm 60 fisso/girevole senza rosetta knob mm 60 fix/turnable w/o rose	77434865601	77434865604	77434865612	77434865623	77434865624	77434865625	10
POM60 CP R51x7 Pomolo mm 60 centroporta rosetta 51x7 knob mm 60 on rose 51x7	77434755501	77434755504	77434755512	77434755523	77434755524	77434755525	1
1 POM60 Q8CP R51x7 Pomoli mm 60 Q8 accoppiati rosetta 51x7 Pair of knobs D60 on rose 51x7mm	77434751001	77434751004	77434751012	77434751023	77434751024	77434751025	1

3



Per istruzioni di montaggio scansiona QR code, seleziona il numero di riferimento e segui le istruzioni.  
For assembly instructions scan the QR code, select the relevant assembly number and follow the instructions.





OLV-M1

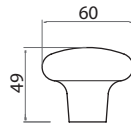

1

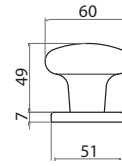
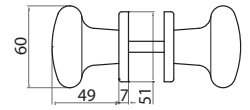
2  
Mont. n°1553  
Mont. n°156

	F1	F4	GCTOL	GCTOS	GCTCL	GCTCS	Conf. Pz.
1 POM60 M10/Q8 S/ROS Pomolo mm 60 fisso/girevole senza rosetta knob mm 60 fix/turnable w/o rose	70143865601	70143865604	70143865612	70143865623	70143865624	70143865625	10
2 POM60 CP R51x7 Pomolo mm 60 centroporta rosetta 51x7 knob mm 60 on rose 51x7	70143755501	70143755504	70143755512	70143755523	70143755524	70143755525	1
3 POM60 Q8CP R51x7 Pomoli mm 60 Q8 accoppiati rosetta 51x7 Pair of knobs D60 on rose 51x7mm	70143751001	70143751004	70143751012	70143751023	70143751024	70143751025	1

## BLINDO



F4

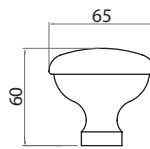

1

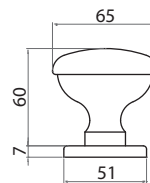
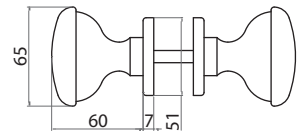
2  
Mont. n°1553  
Mont. n°156

	F4	GCTOL	GCTOS	GCTCL	GCTCS	Conf. Pz.
1 POM65 M10/Q8 S/ROS Pomolo mm 65 fisso/girevole senza rosetta knob mm 65 fix/turnable w/o rose	77194875604	77194875612	77194875623	77194875624	77194875625	10
2 POM65 CP R51X7 Pomolo mm 65 centroporta rosetta 51x7 knob mm 65 on rose 51x7	77194770504	77194770512	77194770523	77194770524	77194770525	1
3 POM65 Q8CP R51x7 Pomoli mm 65 Q8 accoppiati rosetta 51x7 Pair of knobs D65 on rose 51x7mm	77194771004	77194771012	77194771023	77194771024	77194771025	1



Per istruzioni di montaggio scansiona QR code, seleziona il numero di riferimento e segui le istruzioni.  
For assembly instructions scan the QR code, select the relevant assembly number and follow the instructions.



ACS

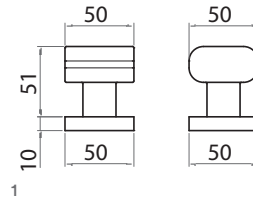

1  
Mont. n°157

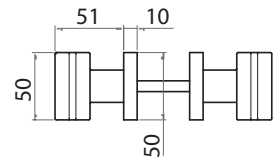

2  
Mont. n°158

	ACS	ACL	Conf. Pz.
1 POM50 CP R50x50 WING POM50 CP R50x50 knob mm 55 on rose 50x50	77792755513	77792755517	1
2 POM50 Q8CP R50x50 WING POM50 Q8CP R50x50 pair of knobs mm 50 8mm rose 50x50	77792751013	77792751017	1

# FRAME



F1-SAT

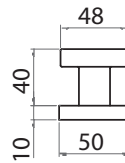

1  
Mont. n°157

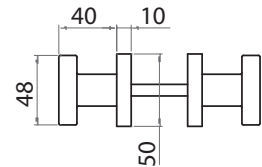

2  
Mont. n°158

	ACL	F1-SAT	Conf. Pz.
1 POM50 CP R50x50 FRAME POM50 CP R50x50 knob mm 55 on rose 50x50	77472755517	77472755533	1
2 POM50 Q8CP R50x50 FRAME POM50 Q8CP R50x50 pair of knobs mm 50 8mm rose 50x50	77472751017	77472751033	1



Per istruzioni di montaggio scansiona QR code, seleziona il numero di riferimento e segui le istruzioni.  
For assembly instructions scan the QR code, select the relevant assembly number and follow the instructions.

## 7071

ALLUMINIO

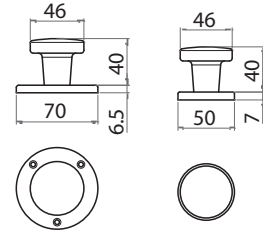

	F1	F3	F4	F9	Conf. Pz.
POM FISSO R70 VV 7071/K2 R70 FISSO 3FV fixed knob on 70 mm round rose screws in view	7707174000119	7707174000319	7707174000419	7707174000919	50

## 7009

ALLUMINIO

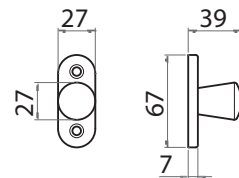

	F1	F3	F4	F9	Conf. Pz.
POM FISSO ROVV 7009/D ROVV FISSO fixed knob on 27x67 rose	77009735301	77009735303	77009735304	77009735309	50



Per istruzioni di montaggio  
scansiona QR code,  
seleziona il numero di  
riferimento e segui le  
istruzioni.  
For assembly instructions  
scan the QR code, select the  
relevant assembly number  
and follow the instructions.

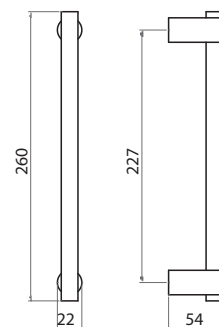

	MERCURY	URANUS	JUPITER	SPACE	Conf. Pz.
MAN DIR	77056600233	77056600234	77056600241	77056600276	1
Maniglione diritto	⚡	⚡	⚡	⚡	
Staight pull handle					

⚡ Servizio G48: Articolo a magazzino e disponibile entro 48 dall'elaborazione dell'ordine. In base a disponibilita' e condizioni di vendita.  
 G48 service: Item in stock and available within 48 hours of order processing. Based on availability and sales conditions.

## 7900

ALLUMINIO GALATTICO

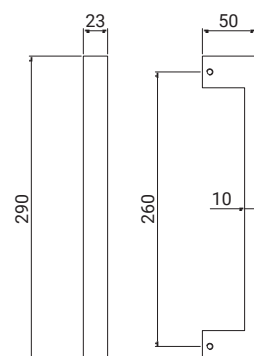

	MERCURY	URANUS	JUPITER	SPACE	Conf. Pz.
MAN DIR	77900600233	77900600234	77900600241	77900600276	1
Maniglione diritto	⚡	⚡	⚡	⚡	
Staight pull handle					

⚡ Servizio G48: Articolo a magazzino e disponibile entro 48 dall'elaborazione dell'ordine. In base a disponibilita' e condizioni di vendita.  
 G48 service: Item in stock and available within 48 hours of order processing. Based on availability and sales conditions.

# AIRONE

OTTONE

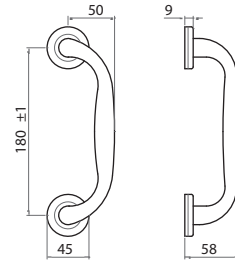

	OLV	OCS	OCL	ONS	Conf. Pz.
MAN ZAN R Maniglione zancato su rosetta offset pull handle on rose	55040612001	55040612003	55040612007	55040612027	1

# COMETA

OTTONE

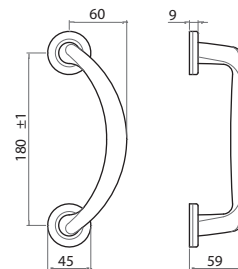

	OLV	OCS	OCL	ONS	Conf. Pz.
MAN ZAN R Maniglione zancato su rosetta offset pull handle on rose	55034612001	55034612003	55034612007	55034612027	1

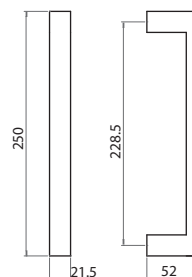

	ZCL	ZCS	ZNO	Conf. Pz.
MAN DIR Maniglione dritto Straight pull handle	66460600207	66460600213	66460600216	1
MAN DIR VET Coppia maniglioni dritti per vetro Straight pull handle for glass	66460606007	66460606013	66460606016	1
MAN DIR L/A Coppia maniglioni dritti per legno/alluminio Straight pull handle for alu / wood	66460607007	66460607013	66460607016	1

# YORK ZANCATO

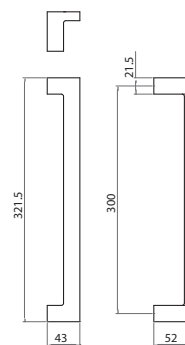

	ZCL	ZCS	ZNO	Conf. Pz.
MAN ZAN Maniglione zancato Offset pull handle	66460610207	66460610213	66460610216	1
MAN ZAN VET Coppia maniglioni zancati per vetro Pair of offset pull handle for glass	66460616007	66460616013	66460616016	1
MAN ZAN L/A Coppia maniglioni zancati per legno/alluminio Pair of pull handle for alu/wood	66460617007	66460617013	66460617016	1

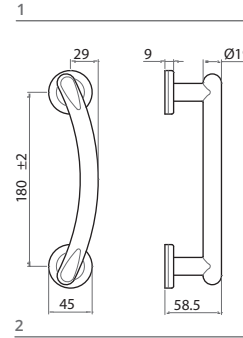
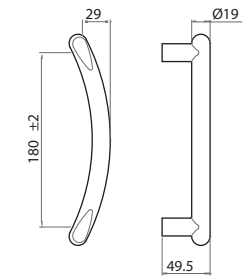

	ZCL	GCTOL	ZCS	ZNO	ZNS	Conf. Pz.
MAN ZAN S/R Maniglione zancato senza rosetta offset pull handle without rose	66096610107	66096610112	66096610113	66096610116	66096610127	1
MAN ZAN VET S/R Coppia maniglioni zancati per vetro senza rosetta Staight pull handle for glass without roses	66096616107	66096616112	66096616113	66096616116	66096616127	1
MAN ZAN L/A S/R Coppia maniglioni zancati per legno/alluminio senza rosetta Staight pull handle for alu/wood without roses	66096617107	66096617112	66096617113	66096617116	66096617127	1
MAN ZAN R Maniglione zancato su rosetta offset pull handle on rose	66096612007	66096612012	66096612013	66096612016	66096612027	1

## EUCLIDE

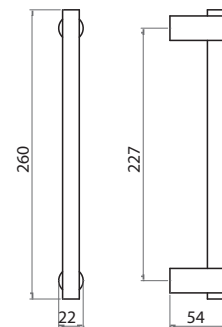

	OCL/F1-SAT	Conf. Pz.
MAN DIR Maniglione diritto Staight pull handle	77056600254	1
MAN DIR VET Coppia maniglioni diritti per vetro Staight pull handle for glass	77056606054	1
MAN DIR L/A Coppia maniglioni diritti per legno/alluminio Staight pull handle for alu / wood	77056607054	1



A	B
1700	1200
1000	800
500	300
400	300

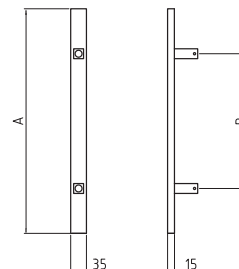

	F1-SAT	Conf. Pz.
MAN DIR Maniglione diritto Q 170 CM interasse ancoraggio cm 120 Staight pull handle	77070017033	1
MAN DIR Maniglione diritto Q 100 CM interasse ancoraggio cm 80 Staight pull handle	77070010033	1
MAN DIR Maniglione diritto Q 50 CM interasse ancoraggio cm 30 Staight pull handle	77070005033	1
MAN DIR Maniglione diritto Q 40 CM interasse ancoraggio cm 30 Staight pull handle	77070004033	1



# ANELLO

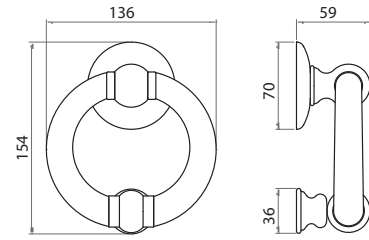

	OLV	OCS	OGV	OLD	OFA	Conf. Pz.
BATTENTE ANELLO Battente ad anello Door knocker	55748200001	55748200003	55748200004	55748200028	55748200029	1

# LEONE

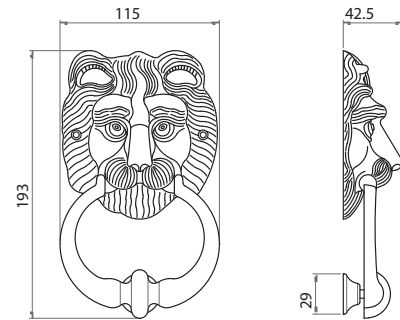

	OLV	OGV	Conf. Pz.
BATTENTE LEONE Battente Leone Door knocker	55098218001	55098218004	1



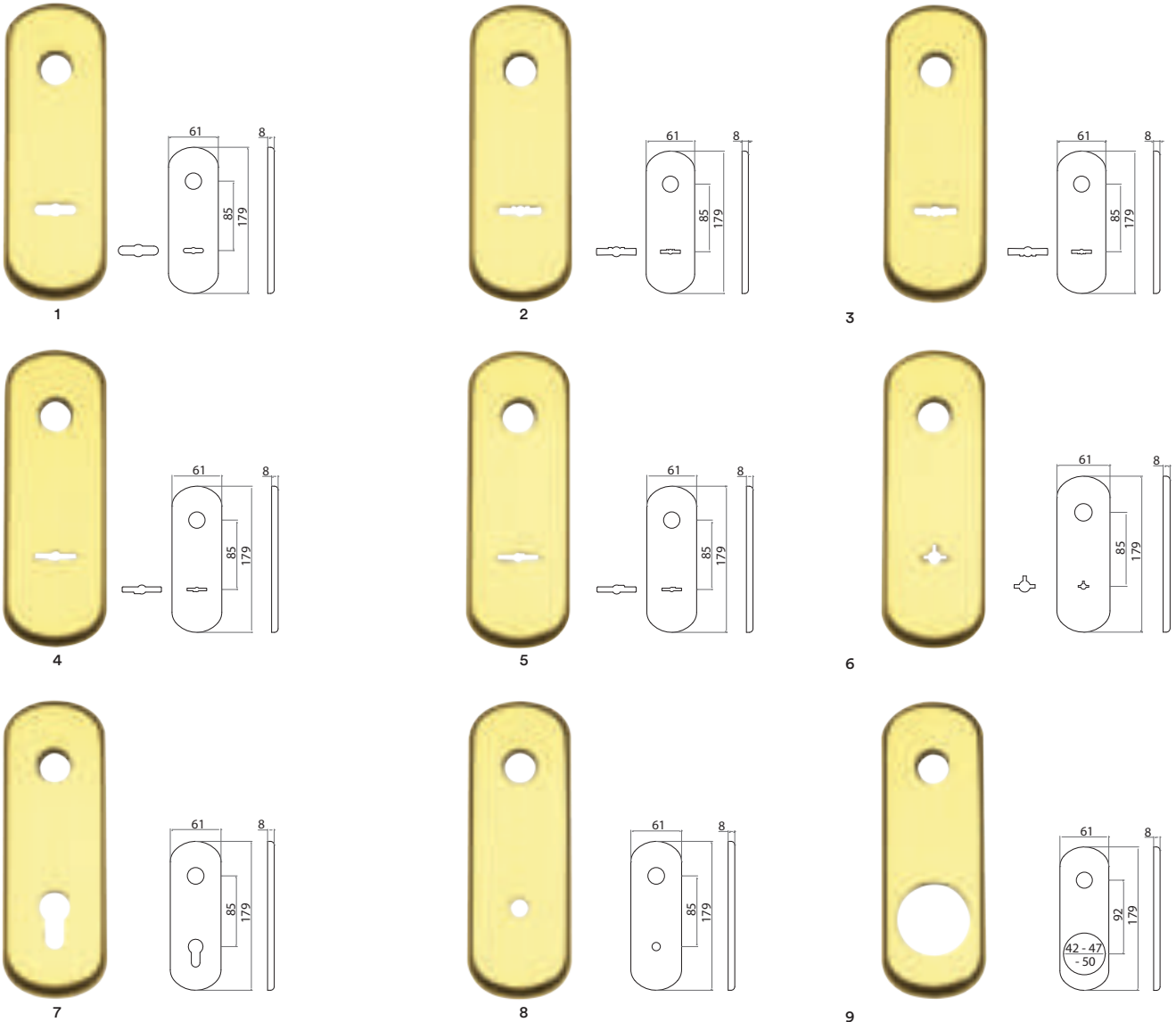

	F1	F4	GCTOL	GCTOS	GCTCL	GCTCS	Conf. Pz.
PL DM/UNIV 85 Placca doppia mappa universale interasse 85 universal double plate for safety lock 85mm	77298852001	77298852004	77298852012	77298852023	77298852024	77298852025	10
PL DM INT 85 Placca doppia mappa interna interasse 85 internal double plate for safety lock 85mm	77298852301	77298852304	77298852312	77298852323	77298852324	77298852325	10
PL DM EST 85 Placca doppia mappa esterna interasse 85 external double plate for safety lock 85mm	77298852401	77298852404	77298852412	77298852423	77298852424	77298852425	10
PL DM/A 85 DX Placca doppia mappa Atra interasse 85 destra double plate for safety lock 85mm right	77298852101	77298852104	77298852112	77298852123	77298852124	77298852125	10
PL DM/A 85 SX Placca doppia mappa Atra interasse 85 sinistra double plate for safety lock 85mm left	77298852201	77298852204	77298852212	77298852223	77298852224	77298852225	10
PL OMEGA Placca OMEGA plate Omega	77298852901	77298852904	77298852912	77298852923	77298852924	77298852925	10
PY85 Placca yale interasse 85 plate with cyl. hole 85mm	77298855001	77298855004	77298855012	77298855023	77298855024	77298855025	10
PL F10 Placca foro D.10 per cilindro con pomolo int 85 plate with 10mm cyl. hole with knob 85mm	77298858101	77298858104	77298858112	77298858123	77298858124	77298858125	10
PL DEF42 Placca Defender D.42 plate for cylinder protection 42mm	77298856501	77298856504	77298856512	77298856523	77298856524	77298856525	10
PL DEF47 Placca Defender D.47 plate for cylinder protection 47mm	77298856701	77298856704	77298856712	77298856723	77298856724	77298856725	10
PL DEF50 Placca Defender D.50 plate for cylinder protection 50mm	77298856601	77298856604	77298856612	77298856623	77298856624	77298856625	10

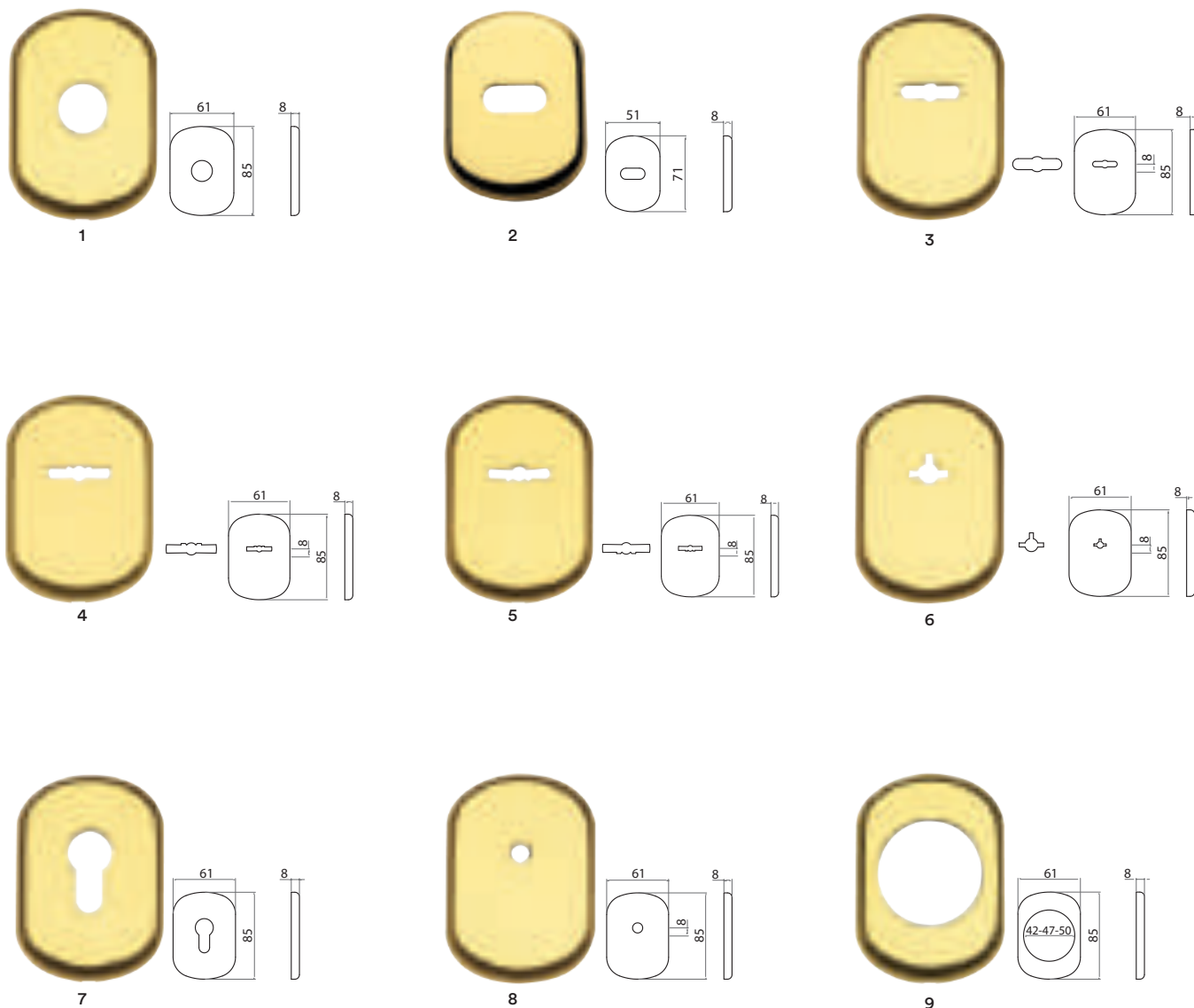

	F1	F4	GCTOL	GCTOS	GCTCL	GCTCS	Conf. Pz.
ROS 62x86 F20	77298521001	77298521004	77298521012	77298521023	77298521024	77298521025	20
GHIBLI ROS 62X86 F20			6,55	7,74			
Rose mm.62X86 with round hole diam. 20							
ROS 52x72 LIM/AP	77298599001	77298599004	77298599012	77298599023	77298599024	77298599025	20
GHIBLI ROS 52X72 L/A							
Rose 52X72 for safety kit							
BOC 62x86 DM/UNIV	77298626001	77298626004	77298626012	77298626023	77298626024	77298626025	20
GHIBLI BOC 62X86 DMU							
Escutcheon 62X70							
BOC 62x86 DM INT	77298626301	77298626304	77298626312	77298626323	77298626324	77298626325	20
GHIBLI BOC 62X86 DMI							
Escutcheon 62X86							
BOC 62x86 DM EST	77298626401	77298626404	77298626412	77298626423	77298626424	77298626425	20
GHIBLI BOC 62X86 DME							
Escutcheon 62X86							
BOC 62x86 OMEGA	77298625901	77298625904	77298625912	77298625923	77298625924	77298625925	20
GHIBLI BOC 62X86 OMEGA							
Escutcheon 62X86 hole type omega							
BOC 62x86 YALE	77298625001	77298625004	77298625012	77298625023	77298625024	77298625025	20
GHIBLI BOC 62X86 YAL							
Escutcheon 62X86 cylinder key hole							
BOC 62x86 F10	77298628101	77298628104	77298628112	77298628123	77298628124	77298628125	20
GHIBLI BOC 62X86 F10							
Escutcheon 62X86 w/hole D.10							
BOC 62x86 DEF42	77298626501	77298626504	77298626512	77298626523	77298626524	77298626525	20
GHIBLI BOC 62X86 D42							
Escutcheon 62X86 hole diam. 42							
BOC 62x86 DEF47	77298626701	77298626704	77298626712	77298626723	77298626724	77298626725	20
GHIBLI BOC 62X86 D47							
Escutcheon 62X86 hole diam. 47							
BOC 62x86 DEF50	77298626601	77298626604	77298626612	77298626623	77298626624	77298626625	20
GHIBLI BOC 62X86 D50							
Escutcheon 62X86 hole diam. 50							

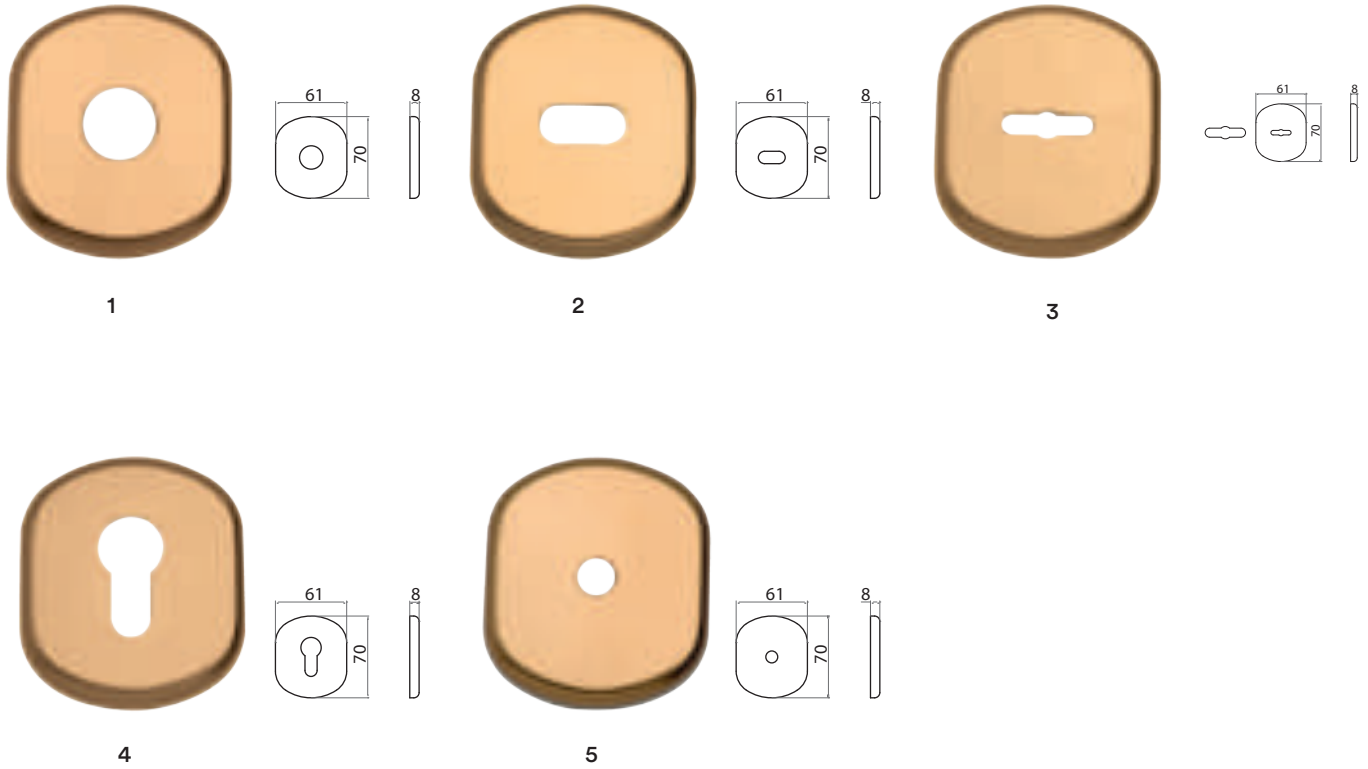

	F1	F4	GCTOL	GCTOS	GCTCL	GCTCS	Conf. Pz.
ROS 62x70 F.20 GHIBLI-2 ROS 62X70 F20 Rose 62X70 with round hole diam.20	77198521001	77198521004	77198521012	77198521023	77198521024	77198521025	20
ROS 62x70 LIM/AP GHIBLI-2 ROS 62X70 L/A Rose 62X70 for safety kit	77198599001	77198599004	77198599012	77198599023	77198599024	77198599025	20
BOC 62x70 DM/UNIV GHIBLI-2 BOC 62X70 DMU Escutcheon 62X70	77198626001	77198626004	77198626012	77198626023	77198626024	77198626025	20
BOC 62x70 YALE GHIBLI-2 BOC 62X70 YAL Cyl key escutcheon 62X70	77198625001	77198625004	77198625012	77198625023	77198625024	77198625025	20
BOC 62x70 F10 GHIBLI-2 BOC 62X70 F10 Escutcheon 62X70	77198628101	77198628104	77198628112	77198628123	77198628124	77198628125	20

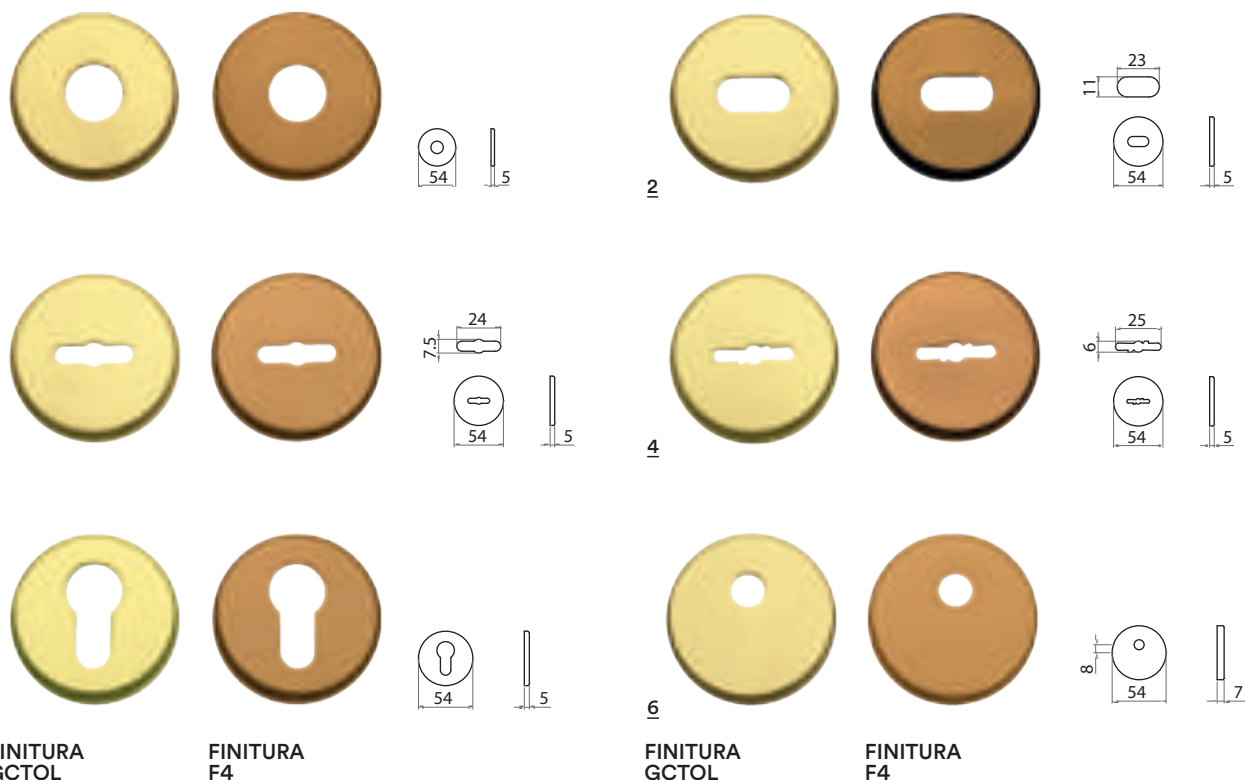

	F1	F4	GCTOL	GCTOS	GCTCL	GCTCS	Conf. Pz.
ROS. D54x5 F/18 Rosetta mm 54x5 foro diametro mm 18 Rose mm 54x5 with hole diam. 18mm	77048501501	77048501504	77048501512	77048501523	77048501524	77048501525	20
ROS. D54X5 L/A Rosetta mm 54x5 per limitatore apertura Rose mm 54x5 for safety kit	77048599201	77048599204	77048599212	77048599223	77048599224	77048599225	20
BOCC. D54x5 DM UNIV. INT. Bocchetta mm 54x5 doppia mappa universale interna (con copri) Inside escutcheon 54x5 for safety lock	77048637301	77048637304	77048637312	77048637323	77048637324	77048637325	20
BOCC. D54x5 DM UNIV. EST. Bocchetta mm 54x5 doppia mappa universale esterna Outside escutcheon 54x5 for safety lock	77048637401	77048637404	77048637412	77048637423	77048637424	77048637425	20
BOCC. D54x5 DM/5 INT. Bocchetta mm 54x5 doppia mappa tipo 5 (Mottura) interna (con) Inside escutcheon 54x5 for safety lock	77048637501	77048637504	77048637512	77048637523	77048637524	77048637525	20
BOCC. D54x5 DM/5 EST. Bocchetta mm 54x5 doppia mappa tipo 5 (Mottura) esterna Outside escutcheon 54x5 for safety lock	77048637601	77048637604	77048637612	77048637623	77048637624	77048637625	20
BOCC. D54x5 YALE Bocchetta mm 54x5 foro Yale Escutcheon 54x5 cyl. hole	77048635201	77048635204	77048635212	77048635223	77048635224	77048635225	20
ROS. 54x7 F10SP Rosetta mm 54x7 foro diametro mm 10 spostato Rose mm 54x7 with hole diam. 10mm	77048540001	77048540004	77048540012	77048540023	77048540024	77048540025	20

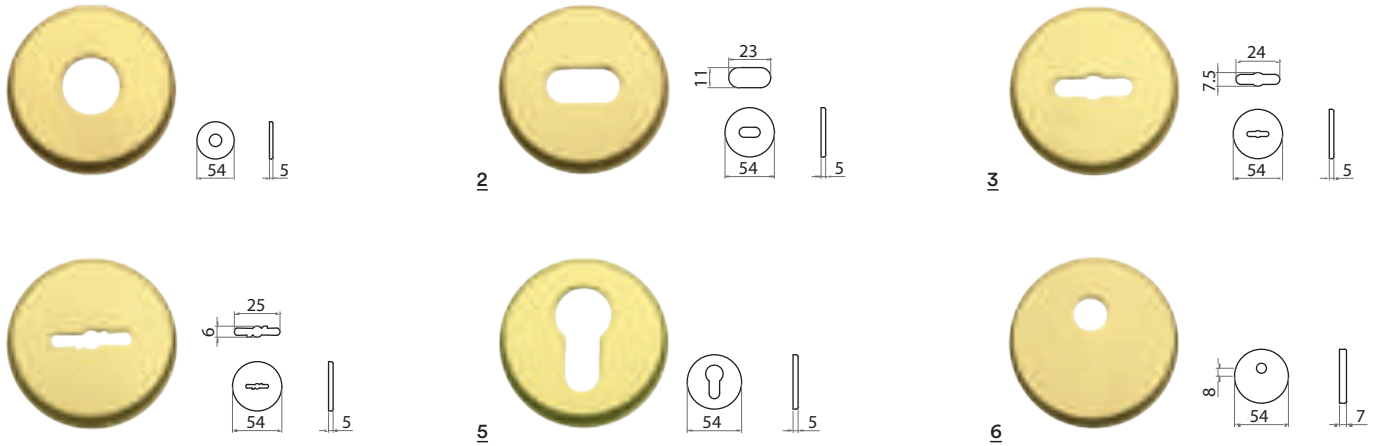

	OLV	OCS	OGV	OCL	OS	Conf. Pz.
ROS. D54x5 F/18 Rosetta mm 54x5 foro diametro mm 18 Rose mm 54X5 with hole diam. 18mm	55748501501	55748501503	55748501504	55748501507	55748501508	20
ROS. D54X5 L/A Rosetta mm 54x5 per limitatore apertura Rose mm 54X5 for safety kit	55748599201	55748599203	55748599204	55748599207	55748599208	20
BOCC. D54x5 DM UNIV. INT. Bocchetta mm 54x5 doppia mappa universale interna (con copril Inside escutcheon 54x5 for safety lock	55748637301	55748637303	55748637304	55748637307	55748637308	20
BOCC. D54x5 DM UNIV. EST. Bocchetta mm 54x5 doppia mappa universale esterna Outside escutcheon 54x5 for safety lock	55748637401	55748637403	55748637404	55748637407	55748637408	20
BOCC. D54x5 DM/5 INT. Bocchetta mm 54x5 doppia mappa tipo 5 (Mottura) interna (con Inside escutcheon 54x5 for safety lock	55748637501	55748637503	55748637504	55748637507	55748637508	20
BOCC. D54x5 DM/5 EST. Bocchetta mm 54x5 doppia mappa tipo 5 (Mottura) esterna Outside escutcheon 54x5 for safety lock	55748637601	55748637603	55748637604	55748637607	55748637608	20
BOCC. D54x5 YALE Bocchetta mm 54x5 foro Yale Escutcheon 54x5 cyl. hole	55748635201	55748635203	55748635204	55748635207	55748635208	20
ROS. 54x7 F10SP Rosetta mm 54x7 foro diametro mm 10 spostato Rose mm 54X7 with hole diam. 10mm	55748540001	55748540003	55748540004	55748540007	55748540008	20

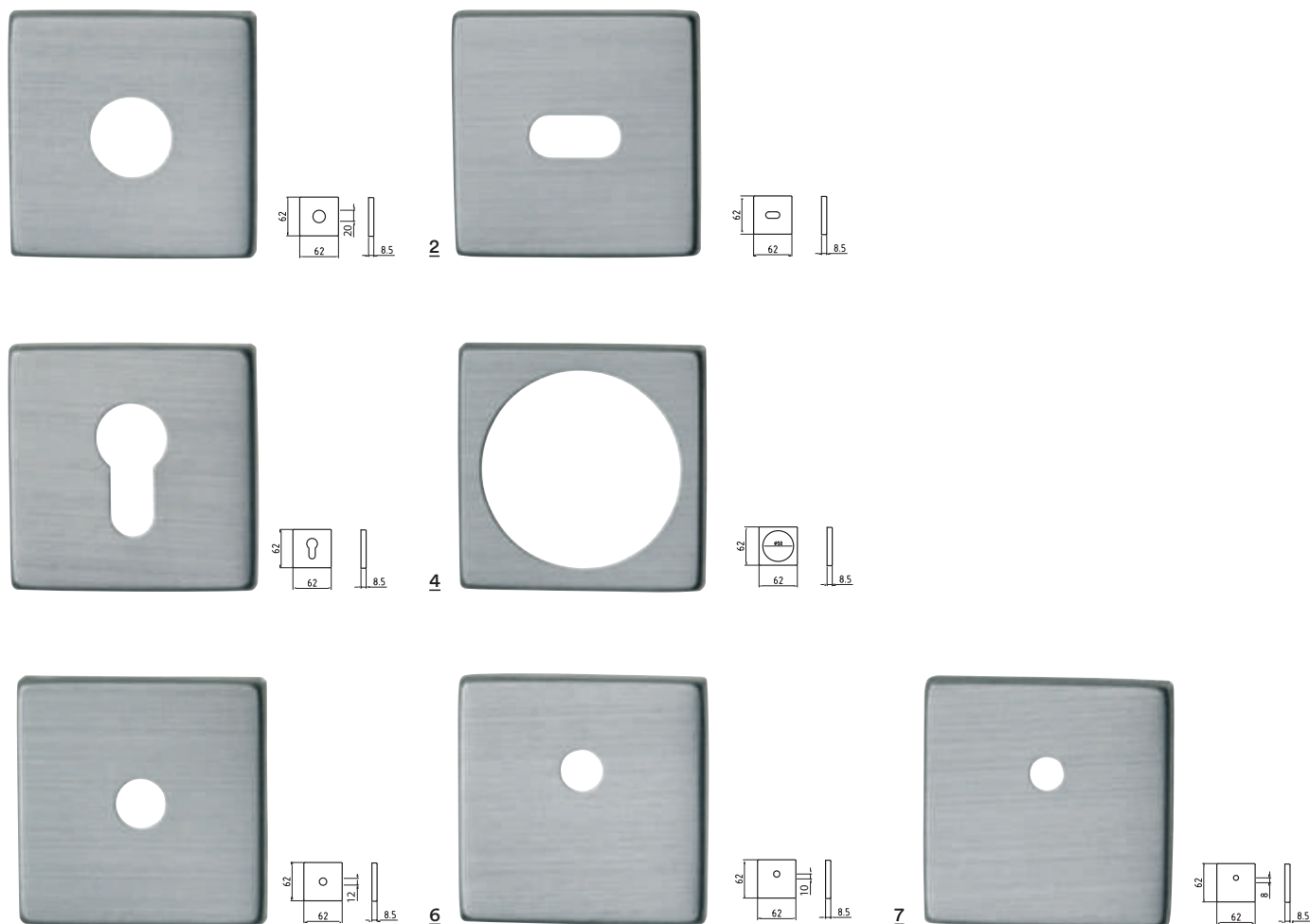

	F1	F4	GCTCL	F1-SAT	Conf. Pz.
ROS Q62x62X8,5 F20 BLINDO ROS Q 62X62X8,5 F.20 Square rose mm.62X62x8,5 with round hole diam. 20	77196572001	77196572004	77196572024	77196572033	20
ROS Q62x62X8,5 LIM/AP BLINDO ROS Q 62x62x8,5 L/A Square rose mm.62X62x8,5 for safety kit	77196599001	77196599004	77196599024	77196599033	20
BOC Q62x62X8,5 YALE BLINDO BOC Q 62x62x8,5 YAL Square escutcheon mm.62X62x8,5 cylinder key hole	77196625001	77196625004	77196625024	77196625033	20
BOC Q62x62X8,5 DEF50 BLINDO BOC Q 62x62x8,5 D50 Escutcheon 62X86 hole diam. 50	77196626601	77196626604	77196626624	77196626633	20
BOC Q62x62X8,5 F12 centrale BLINDO BOC Q 62x62x8,5 F12 centrale Escutcheon 62X86 hole diam. 12	77196572201	77196572204	77196572224	77196572233	20
BOC Q62x62X8,5 F10 SP BLINDO BOC Q 62x62x8,5 F10 Square escutcheon mm.62X62x8,5 D.10	77196572101	77196572104	77196572124	77196572133	20
BOC Q62x62X8,5 F8 SP BLINDO BOC Q 62x62x8,5 F8 SP Escutcheon 62X86 hole diam. 8	77196572801	77196572804	77196572824	77196572833	20



# UNO

OTTONE

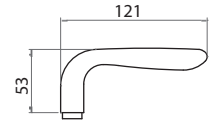

	OLV	OCS	OGV	OCL	OS	Conf. Pz.
IM Q8 GM6TE UNO IM Q8 VB G6T Lever handle 8mm with grub screw M6 visible	55796012301	55796012303	55796012304	55796012307	55796012308	10

# MILENA Z

ZAMA

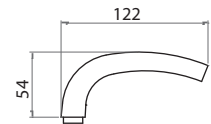

	ZGV	ZCL	GCTOL	ZCS	Conf. Pz.
IM Q8 GM6TE MILENA-Z IM Q8 GM6TE Lever handle 8mm with grub screw M6 visible	66744012304	66744012307	66744012312	66744012313	10

# GM05

ZAMA

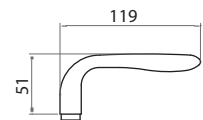

	ZGV	ZCL	GCTOL	ZCS	Conf. Pz.
IM Q8 GM6TE GM05-Z IM Q8 GM6TE Lever handle 8mm with grub screw M6 visible	6GM58012304	6GM58012307	6GM58012312	6GM58012313	10

# SUSY

ALLUMINIO

429

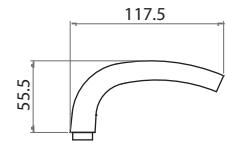

	F1	F4	GCTOL	GCTOS	GCTCL	GCTCS	Conf. Pz.
IM Q8 GM6TE	77434018301	77434018304	77434018312	77434018323	77434018324	77434018325	10
SUSY IM Q8 G6T							
Lever handle 8mm with grub screw M6 visible							

# BRIXIA

ALLUMINIO

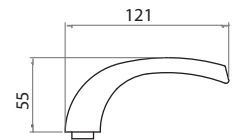

	F1	F4	GCTOL	GCTOS	GCTCL	GCTCS	Conf. Pz.
IM Q8 GM6TE	77438018301	77438018304	77438018312	77438018323	77438018324	77438018325	10
BRIXIA Q8 IM G6T							
Lever handle 8mm with grub screw M6 visible							

## BLINDO

OTTONE

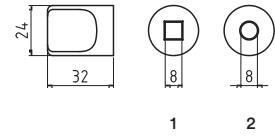

	OLV	OCS	OCL	Conf. Pz.
1 POM Q8 S/ROS BLINDO POM Q8 IM *	55698228301	55698228303	55698228307	10
knob 8mm w/o rose				
2 POM F.8 S/ROS BLINDO POM F8 S/V *	55698228701	55698228703	55698228707	10
knob w/o rose 8mm hole				

## MEZZALUNA

ZAMA

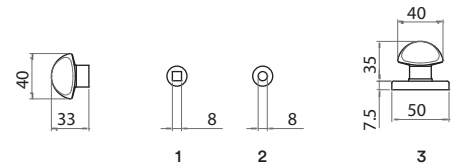
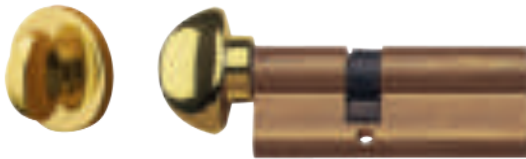

	ZGV	ZCL	GCTOL	ZCS	GCTOS	Conf. Pz.
1 POM Q8 S/ROS MEZZALUNA POM Q8 IM	66748228504	66748228507	66748228512	66748228513	66748228523	10
knob 8mm w/o rose						
2 POM F.8 S/ROS MEZZALUNA POM F8 S/V	66748228704	66748228707	66748228712	66748228713	66748228723	10
knob w/o rose 8mm hole						
3 POM Q8 R50x7 Q8x80 MEZZALUNA POM Q8x80 R51x7	6674822850428	6674822850728	6674822851228	6674822851328	6674822852328	10
knob on rose 50x7 with spindle 8x80mm						

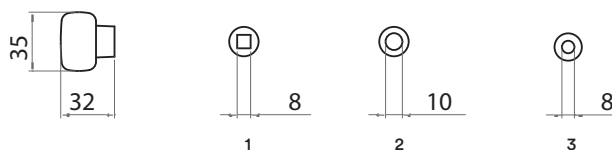

	F1	F4	GCTOL	GCTOS	GCTCL	GCTCS	Conf. Pz.
1 POM35 Q8 S/ROS Pomolo mm 35 Q8 senza rosetta knob mm 35 spindle mm 8 without rose	77486812701	77486812704	77486812712	77486812723	77486812724	77486812725	10
2 POM35 F.10 S/ROS Pomolo mm 35 foro mm 10 senza rosetta knob mm 35 hole mm 10 without rose	77486817301	77486817304	77486817312	77486817323	77486817324	77486817325	10
3 POM35 F.8 S/ROS Pomolo mm 35 foro mm 8 senza rosetta knob mm 35 hole mm 8 without rose	77486816701	77486816704	77486816712	77486816723	77486816724	77486816725	10

# MEZZALUNA

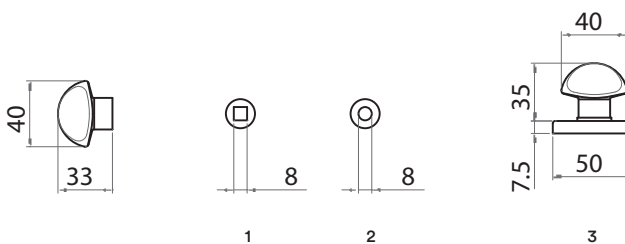
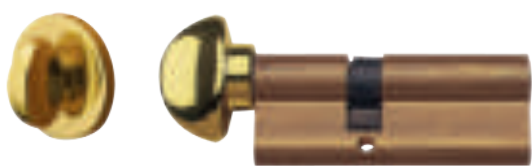

	F1	F4	Conf. Pz.
1 POM Q8 S/ROS MEZZALUNA POM Q8 IM *	77048228501	77048228504	10
2 POM F.8 S/ROS MEZZALUNA POM F8 S/V *	77048228701	77048228704	10
3 POM Q8 R50x7 Q8x80 MEZZALUNA POM Q8x80 R50x7	7704822850128	7704822850428	10

# SUSY

ALLUMINIO

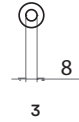
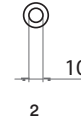
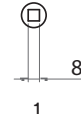
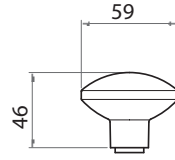

	F1	F4	GCTOL	GCTOS	GCTCL	GCTCS	Conf. Pz.
1 POM40 Q8 S/ROS Pomolo mm 40 Q8 senza rosetta knob mm 40 spindle mm 8 without rose	77434822701	77434822704	77434822712	77434822723	77434822724	77434822725	10
2 POM40 F.10 S/ROS Pomolo mm 40 foro mm 10 senza rosetta knob mm 40 hole mm 10 without rose	77434827301	77434827304	77434827312	77434827323	77434827324	77434827325	10
3 POM40 F.8 S/ROS Pomolo mm 40 foro mm 8 senza rosetta knob mm 40 hole mm 8 without rose	77434816701	77434816704	77434816712	77434816723	77434816724	77434816725	10

# BLINDO

ALLUMINIO

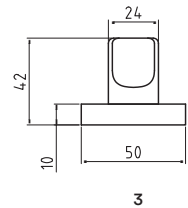
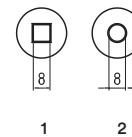
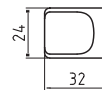

	F1	F4	GCTOL	GCTCL	F1-SAT	Conf. Pz.
1 POM Q8 S/ROS BLINDO POM Q8 IM *	77194228301	77194228304	77194228312	77194228324	77194228333	10
2 POM F.8 S/ROS BLINDO POM F8 S/V *	77194228701	77194228704	77194228712	77194228724	77194228733	10
3 POM Q8 RQ50x7 Q8x80 BLINDO POM Q8x80 RQ50x7 knob on square rose 50x7 with spindle 8x80mm	77194228501	77194228504	77194228512	77194228524	77194228533	10

# KIT BASCULANTE/GARAGE DOORS KIT

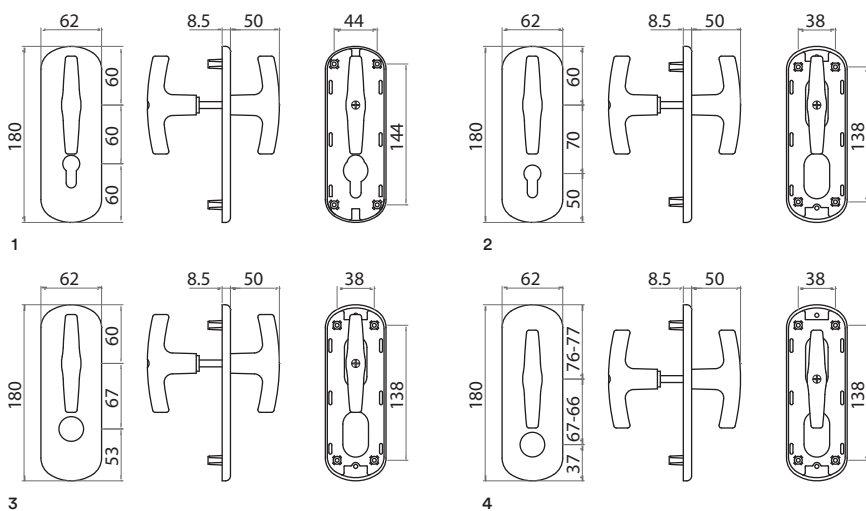

	F1	F4	GCTOL	GCTOS	GCTCL	GCTCS	Conf. Pz.
1 KIT BASCULANTE YALE 60 Kit per basculante yale 60 Garage door kit	77400517001	77400517004	77400517012	77400517023	77400517024	77400517025	1
2 KIT BASCULANTE YALE 70 Kit per basculante yale 70 Garage door kit	77400517501	77400517504	77400517512	77400517523	77400517524	77400517525	1
3 KIT BASCULANTE CIL D25 INT67 Kit per basculante foro cilindro D.25 int.67 Garage door kit	77400518001	77400518004	77400518012	77400518023	77400518024	77400518025	1
4 KIT BASCULANTE CIL D25 INT67 SP Kit per basculante foro cilindro D.25 int.67 spostato Garage door kit	77400518501	77400518504	77400518512	77400518523	77400518524	77400518525	1

# 8

## Acciaio Inox

## Stainless steel

438 Maniglie + dk / Handles + dk  
442 Accessori / Accessories  
443 Maniglioni fissi / Pull handles





L'acciaio è una lega di ferro contenente carbonio fino a circa il 2% ed altri elementi che conferiscono al metallo determinate caratteristiche. In base al loro impiego gli acciai vengono comunemente divisi in acciai di uso generale e acciai speciali. Gli acciai inossidabili (inox) appartengono a questa seconda categoria ed hanno resistenza all'ossidazione ed alla corrosione, caratteristiche determinate dalla presenza in lega di nichel e cromo.

Steel is an iron alloy containing up to 2% carbon and other elements which give the metal certain characteristics. Steels are commonly divided into steels for general use and steels for specific uses according to their final use. Stainless steels belong to the second category and resist oxidation and corrosion, a characteristic which is determined by the presence of nickel and chrome in the alloy.

# STEEL 1



Guarnitura con sottorosetta in Nylon,  
disponibile a richiesta con sottorosetta in acciaio,  
viti passanti, grano in testa e molla di richiamo.  
Guarnitura con rosetta ovale coprivite  
fornita con molla ambidestra.

Seal with nylon rose,  
also available in stainless steel,  
connection and components.  
Seal with oval screw-covering rose  
provided with ambidextrous spring.

		INOX	Conf. Pz.
1	Q8 R Guarnitura Q8 ros. senza bocc. Lever handle 8mm on rose	99546280055	1
1	Q8 RB Guarnitura Q8 ros./bocc. patent Lever handle 8mm on rose key hole escutcheon	99546281055	1
1	Q8 RBY Guarnitura Q8 ros./bocc. yale Lever handle 8mm on rose - cyl. hole escutcheon	99546285055	1
1	Q8 RBWC Guarnitura Q8 ros./bocc. Wc Lever handle 8mm on rose wc hole escutcheon	99546288055	1
2	Q8 ROC Guarnitura Q8 ros.ovale senza bocc. Lever handle 8mm on oval rose	99546220555	1
2	Q8 RBOYC Guarnitura Q8 ros/boc. ovale Yale Lever handle 8mm on oval rose - cyl. hole escutcheon	99546225555	1
3	DK X 40 Martellina DK Q7 x 40 window handle DK x 40 mm	99546557055	2
3	DK X 40 C/BUSS. Martellina DK Q7 x 40 con bussole D. 9,5 window handle DK x 40mm with pins D.9,5	99546558055	2

## PORTA

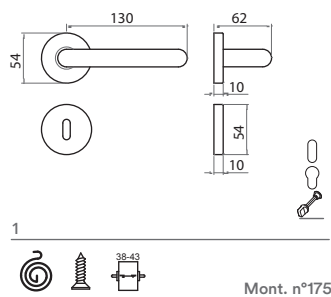

## FINESTRA

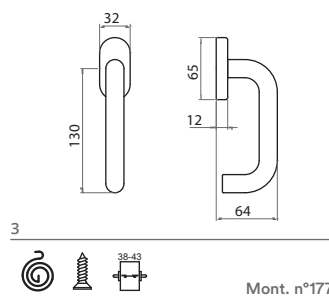
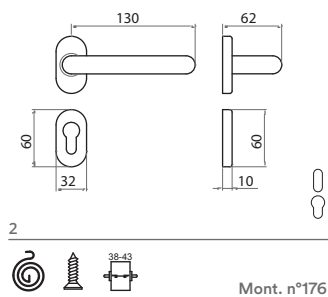

Per istruzioni di montaggio  
scansiona QR code,  
seleziona il numero di  
riferimento e segui le  
istruzioni.  
For assembly instructions  
scan the QR code, select the  
relevant assembly number  
and follow the instructions.

# STEEL 1 L



Guarnitura con sottorosetta in Acciaio inox, viti passanti, grano in testa e molla di richiamo.  
Guarnitura con rosetta ovale coprivite fornita con molla ambidestra.

Seal with stainless steel rose connection and components.  
Seal with oval screw-covering rose provided with ambidextrous spring.

		INOX	Conf. Pz.
1	Q8 R Guarnitura Q8 ros. senza bocc. Lever handle 8mm on rose	99544280055	1
1	Q8 RB Guarnitura Q8 ros./bocc. patent Lever handle 8mm on rose key hole escutcheon	99544281055	1
1	Q8 RBY Guarnitura Q8 ros./bocc. yale Lever handle 8mm on rose - cyl. hole escutcheon	99544285055	1
1	Q8 RBWC Guarnitura Q8 ros./bocc. Wc Lever handle 8mm on rose wc hole escutcheon	99544288055	1
2	Q8 ROC Guarnitura Q8 ros.ovale senza bocc. Lever handle 8mm on oval rose	99544220555	1
2	Q8 RBOYC Guarnitura Q8 ros/boc. ovale Yale Lever handle 8mm on oval rose - cyl. hole escutcheon	99544225555	1

99546

Steel 1 L

## PORTA

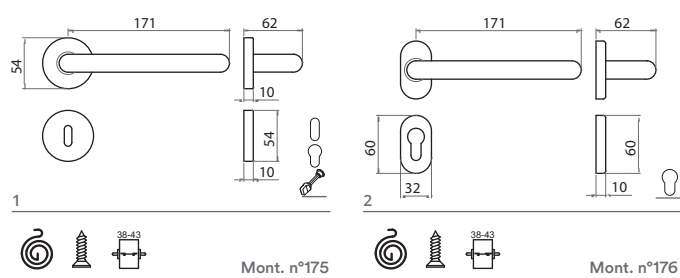

Per istruzioni di montaggio  
scansiona QR code,  
seleziona il numero di  
riferimento e segui le  
istruzioni.  
For assembly instructions  
scan the QR code, select the  
relevant assembly number  
and follow the instructions.

# BOCCHETTE

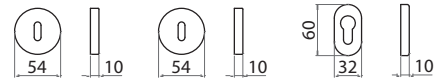

	INOX	Conf. Pz.
BOC PAT Bocchetta patent Round key escutcheon	99548631055	10
BOC YALE Bocchetta Yale Round cyl. Escutcheon	99548635055	10
BOV OVALE YALE Bocchetta ovale yale Oval escutcheon with cyl. hole	99548625055	10

# NOTTOLINO

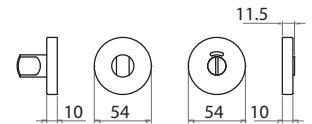

	INOX	Conf. Pz.
NOTT RWC Nottolino WC Q.6 con rosette d.50 M+F Toilet set - spindle 6 mm with rose	99548638055	10

# STEEL 101

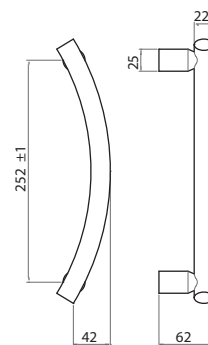

MAN ZAN	INOX	Conf.
STEEL 101 MAN ZAN	99542601255	Pz.
Offset pull handle with accessories		1

# STEEL 102

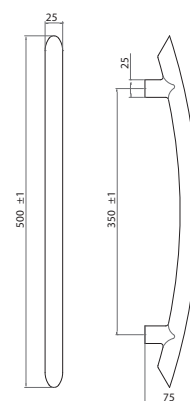

MAN DIR	INOX	Conf.
STEEL 102 MAN DIR	99544600255	Pz.
Straight pull handle with accessories		1
MAN DIR CP	99544600755	Conf.
STEEL 102 MANCP DIR		Pz.
Pair of pull handle with accessories		1



# STEEL 109

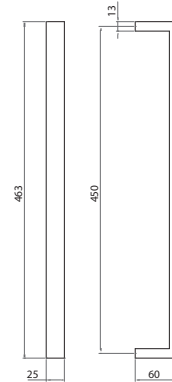

	INOX	Conf. Pz.
MAN DIR STEEL 109 MAN DIR SINGOLO <i>Straight pull handle with accessories</i>	99534600255	1
MAN DIR CP STEEL 109 MANCP DIR <i>Pair of pull handle with accessories</i>	99534600755	1

# STEEL 113

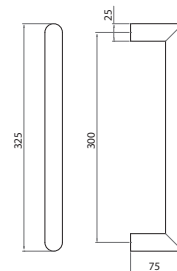

	INOX	Conf. Pz.
MAN DIR Maniglione diritto completo di fissaggio <i>Straight pull handle with accessories</i>	99538600255	1
MAN DIR CP Maniglione diritto accoppiato completo di fissaggio <i>Pair of pull handle with accessories</i>	99538600755	1

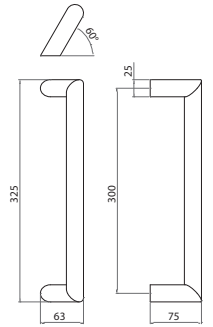

	INOX	Conf. Pz.
MAN ZAN DIR Maniglione zancato diritto con fissaggi Straight pull handle with accessories	99526610255	1
MAN ZAN CP DIR Maniglioni zancati diritti accoppiati con fissaggi paier of straight pull handle with accessories	99526610755	1

# 9

# Nylon

- 452 Maniglie / Handles
- 462 Accessori / Accessories
- 464 Maniglioni fissi / Pull handles
- 465 Pomoli / Knobs
- 466 Appendiabiti / Coat hangers
- 467 Copri avvolgibili / Plates for roller shutters



**Nylon é la denominazione commerciale della poliammide 6.6, resina termoplastica sintetica con elevate proprietà meccaniche e buona resistenza agli agenti chimici. Tutta la produzione in Nylon é ottenuta mediante stampaggio per iniezione.**

**Nylon is the trade name for 6.6 polyamide, a synthetic thermoplastic resin with high mechanical properties and strong resistance to chemical agents. All nylon products are made using injection presses.**

# Finiture Nylon

## Nylon finishing



02

Handles

Nylon

01





# MINNY



NGI



NGR



NAM



NRO



NVE



NMA



NBI

Colori disponibili a magazzino: nero, bianco.  
Per tutti gli altri colori richiedere di volta in volta fattibilità e tempi di consegna. Tutte le versioni cremonesi e martellina sono realizzabili applicando a CREM/MART SG i giochi disponibili a pagina 139.

Storage colors available: black, white.  
For all others colors ask feasibility and delivery times.

	NGI	NGR	NAM	NVE	Conf. Pz.
Q8 BIL Coppia maniglie con Q8 (Bilancino) Pair handle with 8mm spindle	88940208001	88940208002	88940208003	88940208004	8
CREM/MART SG Cremonese-martellina Q7 senza gioco Window handle without mechanism	88940400001	88940400002	88940400003	88940400004	10
	NNE	NMA	NBI	NRO	Conf. Pz.
Q8 BIL Coppia maniglie con Q8 (Bilancino) Pair handle with 8mm spindle	88940208005	88940208006	88940208007	88940208008	8
CREM/MART SG Cremonese-martellina Q7 senza gioco Window handle without mechanism	88940400005	88940400006	88940400007	88940400008	10

88940

Minny

Maniglie

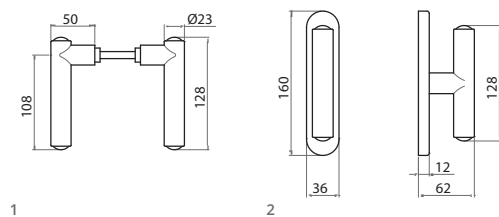

1

2

Nylon

## LIA



NGI



NGR



NAM



NVE



NMA



NBI



NRO

Colori disponibili a magazzino: nero, bianco.  
Per tutti gli altri colori richiedere di volta in volta fattibilità e tempi di consegna. Tutte le versioni cremonesi e martellina sono realizzabili applicando a CREM/MART SG i giochi disponibili a pagina 139.

Storage colors available: black, white.  
For all others colors ask feasibility and delivery times.  
For all dk system it's possible to check systems at page 139.

	NGI	NGR	NAM	NVE	Conf. Pz.
Q8 BIL Coppia maniglie con Q8 (Bilancino) Pair handle with 8mm spindle	88944208001	88944208002	88944208003	88944208004	8
CREM/MART SG Cremonese-martellina Q7 senza gioco Window handle without mechanism	88944400001	88944400002	88944400003	88944400004	10
	NNE	NMA	NBI	NRO	Conf. Pz.
Q8 BIL Coppia maniglie con Q8 (Bilancino) Pair handle with 8mm spindle	88944208005	88944208006	88944208007	88944208008	8
CREM/MART SG Cremonese-martellina Q7 senza gioco Window handle without mechanism	88944400005	88944400006	88944400007	88944400008	10

88944

Lia

Maniglie

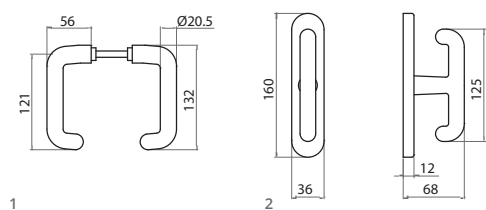

Nylon

# ROMY



NGR



NBE



NRO



Colori disponibili a magazzino: nero, bianco.  
Per tutti gli altri colori richiedere di volta in volta fattibilità e tempi di consegna. Tutte le versioni cremonesi e martellina sono realizzabili applicando a CREM/MART SG i giochi disponibili a pagina 139.

Storage colors available: black, white.  
For all others colors ask feasibility and delivery times.  
For all dk system it's possible to check systems at page 139.

	NGR	NNE	NBI	NRO	Conf. Pz.
Q8 BIL Coppia maniglie con Q8 (Bilancino) Pair handle with 8mm spindle	88934208002	88934208005	88934208007	88934208008	8

88934

Romy

Maniglie

Nylon

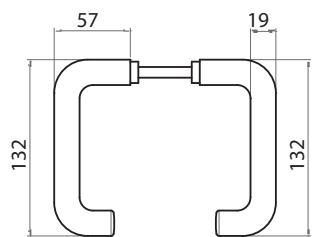

# GIOVE

88894

Giove

Handles



Guarnitura per il serramento in alluminio con doppia molla di ritorno ambidestra e doppio grano.

Alluminium seal with double return spring ambidextrous and double grub.

Q8 RRC	NNE	Conf.
Guarnitura Q8 rosetta rettangolare	88894210005	Pz.
Lever handle 8mm on rectangular rose		6

88894

Giove

Maniglie

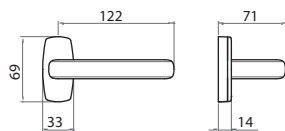

Nylon



# LIA

88944

Lia

Handles



Nylon

	NNE	NBI	Conf. Pz.
POM Q8 BIL Coppia pomoli mm. 55 Q8 pair of knobs mm 55 8mm	88944751905	88944751907	8

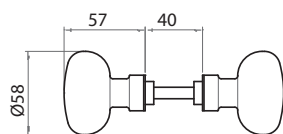

## MINNY

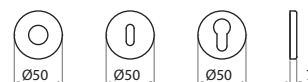

	NNE	NMA	NBI	NRO	Conf. Pz.
ROS TONDA Rosetta tonda round rose	88948531005	88948531006	88948531007	88948531008	16
BOC TONDA PAT Bocchetta tonda patent Round key escutcheon	88948631005	88948631006	88948631007	88948631008	16
BOC TONDA YALE Bocchetta tonda Yale Round cyl. Escutcheon	88948635005	88948635006	88948635007	88948635008	16

	NGI	NGR	NAM	NVE	Conf. Pz.
ROS TONDA Rosetta tonda round rose	88948531001	88948531002	88948531003	88948531004	16
BOC TONDA PAT Bocchetta tonda patent Round key escutcheon	88948631001	88948631002	88948631003	88948631004	16
BOC TONDA YALE Bocchetta tonda Yale Round cyl. Escutcheon	88948635001	88948635002	88948635003	88948635004	16

## MINNY

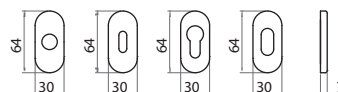

	NNE	NMA	NBI	NRO	Conf. Pz.
ROS OVALE Rosetta ovale oval rose	88948521005	88948521006	88948521007	88948521008	16
BOC OVALE PAT Bocchetta ovale patent Oval escutcheon with key hole	88948621005	88948621006	88948621007	88948621008	16
BOC OVALE YALE Bocchetta ovale Yale Oval escutcheon with cyl. hole	88948625005	88948625006	88948625007	88948625008	16
BOC OVALE F/O Bocchetta ovale foro cilindro ovale Oval escutcheon with cyl. hole	88948622005	88948622006	88948622007	88948622008	16

	NGI	NGR	NAM	NVE	Conf. Pz.
ROS OVALE Rosetta ovale oval rose	88948521001	88948521002	88948521003	88948521004	16
BOC OVALE PAT Bocchetta ovale patent Oval escutcheon with key hole	88948621001	88948621002	88948621003	88948621004	16
BOC OVALE YALE Bocchetta ovale Yale Oval escutcheon with cyl. hole	88948625001	88948625002	88948625003	88948625004	16
BOC OVALE F/O Bocchetta ovale foro cilindro ovale Oval escutcheon with cyl. hole	88948622001	88948622002	88948622003	88948622004	16

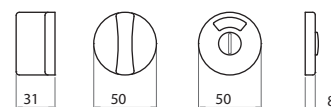

	NVE	NNE	NMA	NBI	NRO	Conf. Pz.
NOTT RWC Nottolino WC Q.6 con rosette Toilet set Q 6 with rose	88948638004	88948638005	88948638006	88948638007	88948638008	10

# MINNY

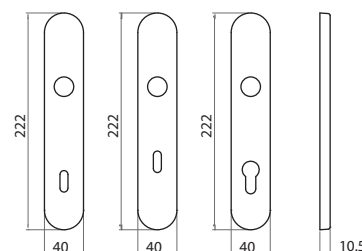

	NNE	NMA	NBI	NRO	Conf. Pz.
P90 Placca patent 90 plate with key hole 90mm	88948851005	88948851006	88948851007	88948851008	16
P70 Placca patent 70 plate with key hole 70mm	88948857005	88948857006	88948857007	88948857008	16
PY85 Placca Yale 85 plate with cyl. hole 85mm	88948855005	88948855006	88948855007	88948855008	16

	NGI	NGR	NAM	NVE	Conf. Pz.
P90 Placca patent 90 plate with key hole 90mm	88948851001	88948851002	88948851003	88948851004	16
P70 Placca patent 70 plate with key hole 70mm	88948857001	88948857002	88948857003	88948857004	16
PY85 Placca Yale 85 plate with cyl. hole 85mm	88948855001	88948855002	88948855003	88948855004	16

## MINNY

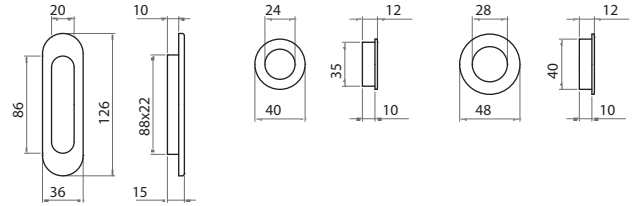

	NMA	NBI	NRO	Conf. Pz.
MINNY INCAS Maniglia incasso ovale sliding door handle	88948700006	88948700007	88948700008	24
MINNY INCAS MM 35 Maniglia incasso tonda mm 35 Round sliding door mm.35	88948735006	88948735007	88948735008	50
MINNY INCAS MM 40 Maniglia incasso tonda mm 40 Round sliding door mm.40	88948740006	88948740007	88948740008	50

	NGR	NAM	NVE	NNE	Conf. Pz.
MINNY INCAS Maniglia incasso ovale sliding door handle	88948700002	88948700003	88948700004	88948700005	24
MINNY INCAS MM 35 Maniglia incasso tonda mm 35 Round sliding door mm.35	88948735002	88948735003	88948735004	88948735005	50
MINNY INCAS MM 40 Maniglia incasso tonda mm 40 Round sliding door mm.40	88948740002	88948740003	88948740004	88948740005	50

## LIA

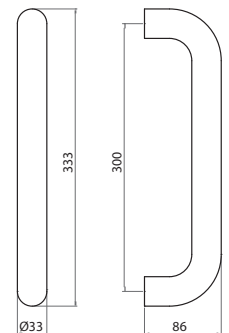

FISSAGGI NON INCLUSI  
FIXINGS NOT INCLUDED

	NGR	NNE	NMA	NBI	NRO	Conf. Pz.
MAN 300 DIR Maniglione diritto mm 300 Straight pull handle	88944602002	88944602005	88944602006	88944602007	88944602008	1

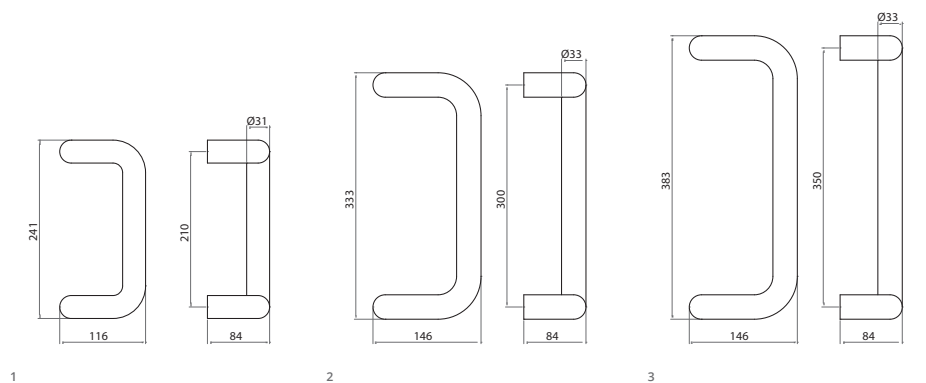

FISSAGGI NON INCLUSI  
FIXINGS NOT INCLUDED

	NGR	NNE	NMA	NBI	NRO	Conf. Pz.
MAN 350 ZAN Maniglione zancato mm 350 offset pull handle mm. 350	88944613002	88944613005	88944613006	88944613007	88944613008	1
MAN 300 ZAN Maniglione zancato mm 300 Offset pull handle mm.300	88944612002	88944612005	88944612006	88944612007	88944612008	1

	NNE	NBI	Conf. Pz.
FISS SING VETRO MAN MM 300/350 Fissaggio singolo per vetro man. mm 300/350 Accessories for single pull handle mm.300/350 glass door	88944687005	88944687007	1
FISS SING LEGNO-ALLUM MAN MM 300/350 Fissaggio singolo per legno alluminio man. mm 300/350 Accessories for single pull handle mm.300/350 alu-wood door	88944687505	88944687507	1
FISS DOPP VETRO MAN MM 300/350 Fissaggio doppio per vetro man. mm 300/350 Accessories for a pair of pull handle glass mm 300/350	88944688005	88944688007	1
FISS DOPP LEGNO-ALLUM MAN MM 300/350 Fissaggio doppio per legno-alluminio man. mm 300/350 Accessories for a pair of pull handle mm.300/350 alu-wood door	88944688505	88944688507	1

UN FISSAGGIO SINGOLO PER OGNI MANIGLIONE

UN FISSAGGIO DOPPIO PER OGNI COPPIA DI MANIGLIONI

## PIPPO

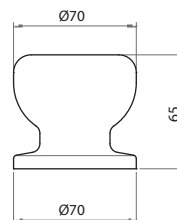

	NNE	NMA	NBI	NRO	Conf. Pz.
POM CP R70 PIPPO POM70 CP knob mm 70	88942770005	88942770006	88942770007	88942770008	8

# MINNY

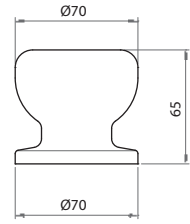

	NNE	NMA	NBI	NRO	Conf. Pz.
POM CP R70 MINNY POM70 CP knob mm 70	88940770005	88940770006	88940770007	88940770008	8

# DUMBO

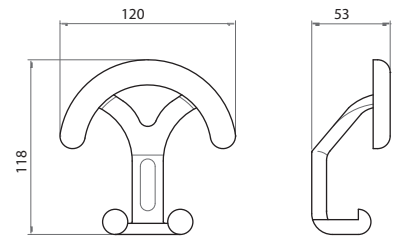

	NGI	NGR	NVE	NNE	NBI	NRO	Conf. Pz.
PORT DUMBO PORT hat & coat hook	88946690001	88946690002	88946690004	88946690005	88946690007	88946690008	12

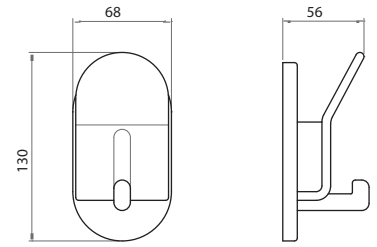

	NGI	NGR	NVE	NNE	NBI	NRO	Conf. Pz.
PORT MINNY PORT hat & coat hook	88940690001	88940690002	88940690004	88940690005	88940690007	88940690008	12

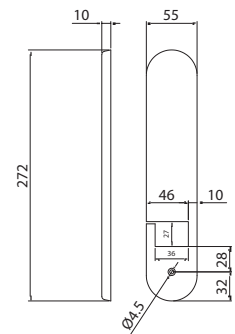

	NNE	NBI	Conf. Pz.
AVV Copriavvolgibile cover	88948800005	88948800005	



# 10

**Coordinati e  
complementi d'arredo**

**Accessories and  
furniture fittings  
and miscellaneous items**

- 470 Ganci rigidi / Door hooks
- 470 Cricchetti / Ratchet windows
- 471 Pinze fermaporte / Door stopper clamp
- 471 Copri avvolgibili / Plates for roller shutter
- 472 Fermaporte / Doorstop
- 473 Supporti / Handrail supports
- 474 Piedini / Brass adjusting screws
- 475 Maniglie ponte / Bridge handles

# GANCI RIGIDI

OTTONE - ALLUMINIO



	A
mm 80	80
mm100	100
mm120	120
mm140	140

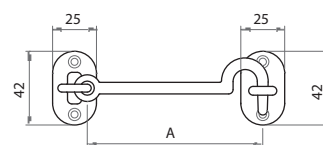

	OBR	OLV	OCL	Conf. Pz.
GANCIO MM80 RIG Gancio rigido mm 80 Hook mm 80	49208080000	49208080001	49208080003	24
GANCIO MM100 RIG Gancio rigido mm 100 Hook mm 100	49208100000	49208100001	49208100003	24
GANCIO MM120 RIG Gancio rigido mm 120 Hook mm 120	49208120000	49208120001	49208120003	24
GANCIO MM140 RIG Gancio rigido mm 140 Hook mm 140	49208140000	49208140001	49208140003	24

# CRICCHETTI

OTTONE - ALLUMINIO

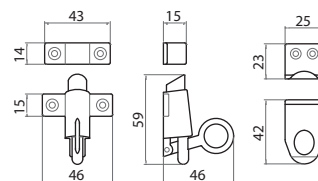

	OBR	OL	Conf. Pz.
CRICCHETT INC NORM Special window hook	49204100000	49204100001	25
CRICCHETT INC STAFFA Special window hook	49204200000	49204200001	25

# PINZE FERMAPORTE

OTTONE - ALLUMINIO

471

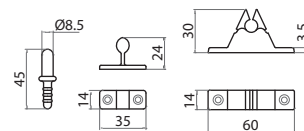
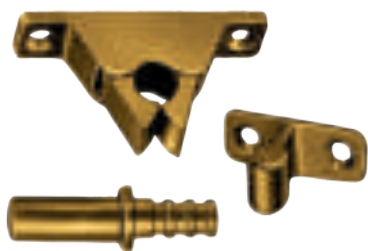

	OBR	OL	Conf. Pz.
PINZA F/PORT	49206000000	49206000001	50
door stop pliers			
PRESA PINZA LEGNO	49206500000	49206500001	50
fitting for door stop plier			
PRESA PINZA TERRA	49206520000	49206520001	50
fitting for door stop plier			

# GIOIA

OTTONE

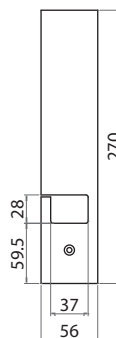

AL FINE DI EVITARE UN DETERIORAMENTO DELLA FINITURA SI CONSIGLIA DI RICAVARE IL SECONDO FORO VITE FORANDO DAL RETRO.

IN ORDER TO AVOID THE FINISHING'S DETERIORATION IT'S RECOMMENDED TO OBTAIN THE SECOND SCREW HOLE DRILLING FROM THE BACK.

	OLV	OCS	OGV	OCL	OS	Conf. Pz.
AVV AVVOLGIBILE RETTANGOLARE cover	44998800001	44998800003	44998800004	44998800007	44998800008	12

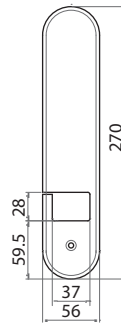

AL FINE DI EVITARE UN DETERIORAMENTO DELLA FINITURA SI CONSIGLIA DI RICAVARE IL SECONDO FORO VITE FORANDO DAL RETRO.

IN ORDER TO AVOID THE FINISHING'S DETERIORATION IT'S RECOMMENDED TO OBTAIN THE SECOND SCREW HOLE DRILLING FROM THE BACK.

	OLV	OLS	OCS	OGV	OCL	Conf. Pz.
AVV						
GIOIA AVV	55448800001	55448800002	55448800003	55448800004	55448800007	12
cover						

## POMELLI FERMAPORTE

ALLUMINIO

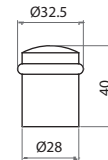

	F1	F4	GCTOL	GCTNS	Conf. Pz.
POM F/POR GOMMA	77225000001	77225000004	77225000012	77225000027	25
POM F/POR 28X40 ALL					
door stopper					

## POMELLI FERMAPORTE

OTTONE

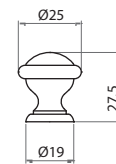

	OBR	OLV	OCL	Conf. Pz.
POM F/POR GOMMA	49225000000	49225000001	49225000007	25
POM.F/POR GOMMA				
door stopper				

# SUPPORTI PER CORRIMANO

OTTONE

473

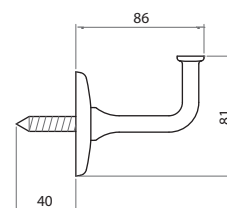
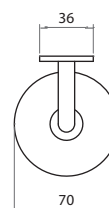
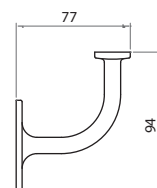
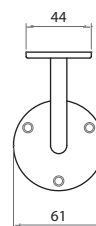
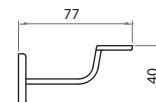
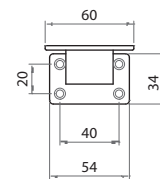

	OBR	OLV	OCS	Conf. Pz.
SUPPORTO QUADR CORR SUPPORTO MM70 CORR hand rail bracket	49235101000	49235101001	49235101003	24
SUPPORTO TONDO CORR SUPPORTO TONDO CORR hand rail bracket	49235201000	49235201001		12
SUPPORTO TONDO CORR C/V SUPPORTO TONDO CORR C/V hand rail bracket	49235251000	49235251001		12

# PIEDINI

OTTONE

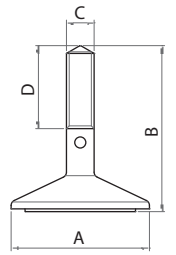

	A	B	C	B
50 M12	50	60	M12	30
60 M12	60	60	M12	30

	Grezzo	Conf. Pz.
PIED.REG.MM50 M12 C/G	49219125001	
PIED.REG. MM50 12MA C/G		60
accessories for furniture 50mm		
PIED.REG.MM60 M12 C/G	49219126001	
PIED.REG. MM60 12MA C/G		50
accessories for furniture 60mm		

# PIEDINI

OTTONE

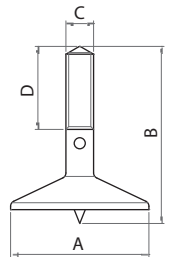

	A	B	C	B
50 M12	50	60	M12	30
60 M12	60	60	M12	30

	Grezzo	Conf. Pz.
PIED.REG.MM50 M12 C/P	49217125001	
PIED.REG. MM50 12MA C/P		60
accessories for furniture 50mm		
PIED.REG.MM60 M12 C/P	49217126001	
PIED.REG. MM60 12MA C/P		50
accessories for furniture 60mm		

# PIEDINI

OTTONE

475



	A	B	C	B
30 M10	30	28	M10	15
35 M10	35	32	M10	18
40 M10	40	32	M10	17
50 M10	50	40	M10	22
60 M10	60	55	M10	30
50 M12	50	40	M10	22
60 M12	60	50	M10	26

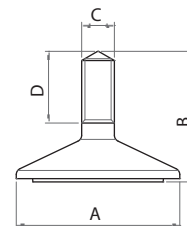

	Grezzo	Conf. Pz.
PIED.FIS.MM30 M10 C/G	49218103001	
PIED.FIS. MM30 10MA C/G accessories for furniture 30mm		200
PIED.FIS.MM35 M10 C/G	49218103501	
PIED.FIS. MM35 10MA C/G accessories for furniture 35mm		200
PIED.FIS.MM40 M10 C/G	49218104001	
PIED.FIS. MM40 10MA C/G accessories for furniture 40mm		100
PIED.FIS.MM50 M10 C/G	49218105001	
PIED.FIS. MM50 10MA C/G accessories for furniture 50mm		100
PIED.FIS.MM60 M10 C/G	49218106001	
PIED.FIS. MM60 10MA C/G accessories for furniture 60mm		100
PIED.FIS.MM50 M12 C/G	49218125001	
PIED.FIS. MM50 12MA C/G accessories for furniture 50mm		100
PIED.FIS.MM60 M12 C/G	49218126001	
PIED.FIS. MM60 12MA C/G accessories for furniture 60mm		50

# MANIGLIETTA PONTE

OTTONE

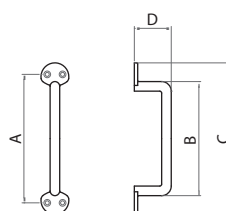
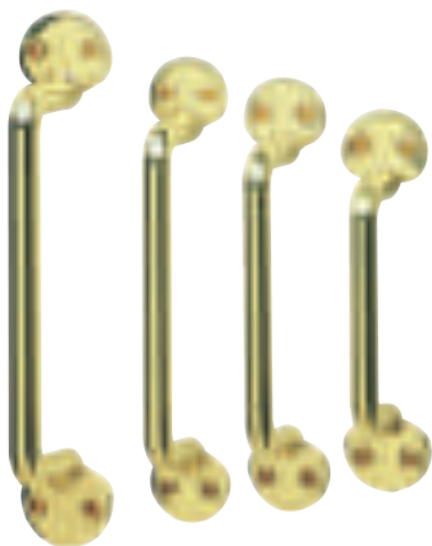

INTER-ASSE	A	B	C	C
100	84	123	35	
mm100	120	104	143	35
mm120	134	119	158	35
mm140	160	140	188	40
mm160				

FINITURA FINISHING  
OLV-M1

	OLV	OGV	Conf. Pz.
MAN PONTE MM 100 Maniglietta a ponte mm 100 Carrying handle	49236100001	49236100004	24
MAN PONTE MM 120 Maniglietta a ponte mm 120 Carrying handle 120	49236120001	49236120004	24
MAN PONTE MM 140 Maniglietta a ponte mm 140 Carrying handle 140	49236140001	49236140004	24
MAN PONTE MM 160 Maniglietta a ponte mm 160 Carrying handle 160	49236160001	49236160004	24

Coordinati e complementi d'arredo



# 11

**Accessori per infissi esterni**

**Windows accessories  
equipment**

478 Arsenio  
479 Ometti

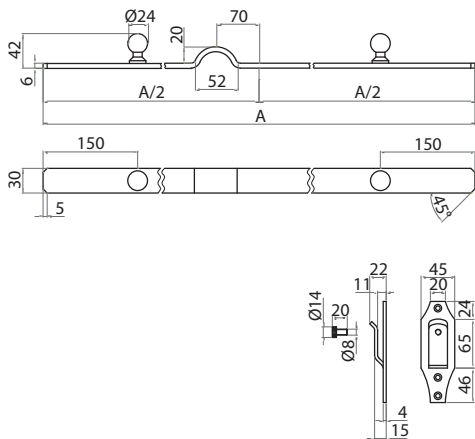

	FZTN	Conf. Pz.
ASTA DI SICUREZZA CM. 60 Asta di sicurezza cm.60 Safety bar cm.60	33182060007	10
ASTA DI SICUREZZA CM. 70 Asta di sicurezza cm.70 Safety bar cm.70	33182070007	10
ASTA DI SICUREZZA CM. 80 Asta di sicurezza cm.80 Safety bar cm.80	33182080007	10
ASTA DI SICUREZZA CM. 90 Asta di sicurezza cm.90 Safety bar cm.90	33182090007	10
ASTA DI SICUREZZA CM. 100 Asta di sicurezza cm.100 Safety bar cm.100	33182100007	10
ASTA DI SICUREZZA CM. 110 Asta di sicurezza cm.110 Safety bar cm.110	33182110007	10
ASTA DI SICUREZZA CM. 120 Asta di sicurezza cm.120 Safety bar cm.120	33182120007	10
ASTA DI SICUREZZA CM. 140 Asta di sicurezza cm.140 Safety bar cm.140	33182140007	10
INCONTRO CON CHIUSURA Incontro con chiusura Hook	33184500007	10

# OMETTI SENZA VITE / SHUTTER STOP WITHOUT SCREW

FERRO

479

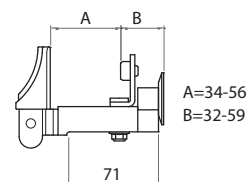

	FZTN	Conf. Pz.
ASTA DI SICUREZZA CM. 60 Asta di sicurezza cm.60 Safety bar cm.60	33182060007	10
ASTA DI SICUREZZA CM. 70 Asta di sicurezza cm.70 Safety bar cm.70	33182070007	10
ASTA DI SICUREZZA CM. 80 Asta di sicurezza cm.80 Safety bar cm.80	33182080007	10
ASTA DI SICUREZZA CM. 90 Asta di sicurezza cm.90 Safety bar cm.90	33182090007	10
ASTA DI SICUREZZA CM. 100 Asta di sicurezza cm.100 Safety bar cm.100	33182100007	10
ASTA DI SICUREZZA CM. 110 Asta di sicurezza cm.110 Safety bar cm.110	33182110007	10
ASTA DI SICUREZZA CM. 120 Asta di sicurezza cm.120 Safety bar cm.120	33182120007	10
ASTA DI SICUREZZA CM. 140 Asta di sicurezza cm.140 Safety bar cm.140	33182140007	10
INCONTRO CON CHIUSURA Incontro con chiusura Hook	33184500007	10

# PROTEZIONE IN PVC / PVC PROTECTION

FERRO



	PVC	Conf. Pz.
PROTEZIONE PER TESTA ALTA Protezione per testa alta Rubber protection	18409110005	10

1

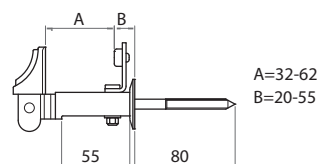

2

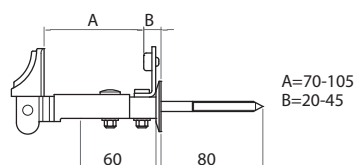

3

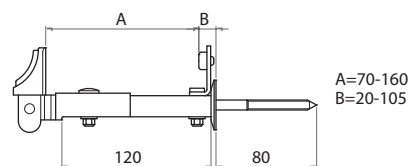

	FZT	FZTN	Conf. Pz.
OMETTO BIG VITE 2RG Ometto BIG con vite 2 regolazioni Shutter stop	33030290006	33032290007	20
OMETTO BIG VITE 2RG TESTA ALTA Ometto BIG con vite 2 regolazioni testa alta Shutter stop	33030290106	33032290107	20
OMETTO BIG VITE 2RG SP. ANTA 70 Ometto BIG con vite 2 regolazioni spessore anta mm 70 Shutter stop	33030291006	33032291007	20
OMETTO BIG VITE 2RG SP. ANTA 70 TESTA ALTA Ometto BIG con vite 2 regolazioni spessore anta mm 70 testa al Shutter stop	33030291106	33032291107	20
OMETTO BIG VITE 2RG DOPPIO Ometto BIG con vite 2 regolazioni doppio Shutter stop	33030295006	33032295007	15
OMETTO BIG VITE 2RG DOPPIO TESTA ALTA Ometto BIG con vite 2 regolazioni doppio testa alta Shutter stop	33030295106	33032295107	15

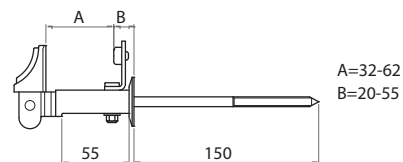

4

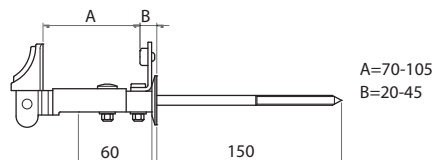
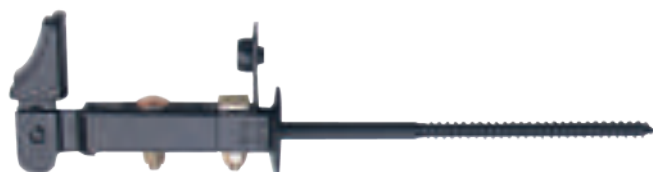

5

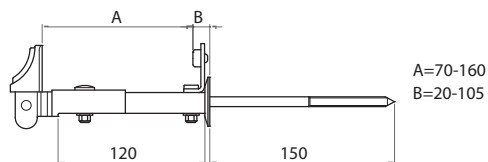

6

	FZT	FZTN	Conf. Pz.
OMETTO BIG VITE 150 2RG Ometto BIG con vite mm 150 2 regolazioni Shutter stop	33030300006	33032300007	15
OMETTO BIG VITE 150 2RG TESTA ALTA Ometto BIG con vite mm 150 2 regolazioni testa alta Shutter stop	33030300106	33032300107	15
OMETTO BIG VITE 150 2RG SP. ANTA 70 Ometto BIG con vite mm 150 2 regolazioni spessore anta mm 7( Shutter stop	33030301006	33032301007	15
OMETTO BIG VITE 150 2RG SP. ANTA 70 TESTA ALTA Ometto BIG con vite mm 150 2 regolazioni spessore anta mm 7( Shutter stop	33030301106	33032301107	15
OMETTO BIG VITE 150 2RG DOPPIO Ometto BIG con vite mm 150 2 regolazioni doppio Shutter stop	33030305006	33032305007	10
OMETTO BIG VITE 150 2RG DOPPIO TESTA ALTA Ometto BIG con vite mm 150 2 regolazioni doppio testa alta Shutter stop	33030305106	33032305107	10

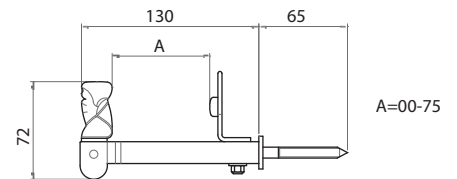
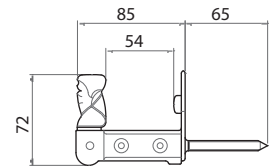
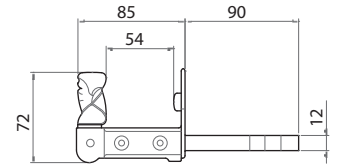

	FN	FZT	FZTN	Conf. Pz.
OMETTO FERMO ZANCA Ometto con fermo e zanca Shutter stop	33030100005	33030100006	33030100007	20
OMETTO FOGLIA REGIS ZANCA Ometto con foglia registrabile e zanca Shutter stop	33030120005	33030120006	33030120007	20
OMETTO FERMO VITE TAS Ometto con fermo vite e tassello Shutter stop	33030150005	33030150006	33030150007	20
OMETTO FOGL REGIS VITE Ometto con foglia registrabile e vite Shutter stop	33030170005	33030170006	33030170007	20

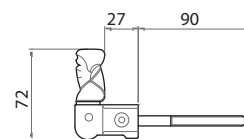
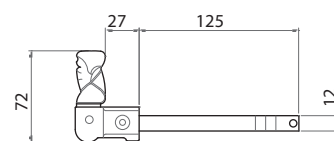
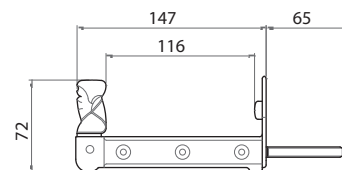

OMETTO FERMO VITE TAS DOP Ometto con fermo vite e tassello doppio Shutter stop	FN	FZT	FZTN	Conf. Pz.
	33030155005	33030155006	33030155007	15
OMETTO ZANCA Ometto con zanca Shutter stop	FN	FZT		Conf. Pz.
	33030000005	33030000006		30
OMETTO VITE TAS Ometto con vite e tassello Shutter stop	FN	FZT		Conf. Pz.
	33030050005	33030050006		30





13

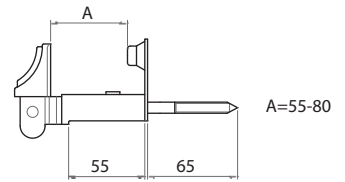

14

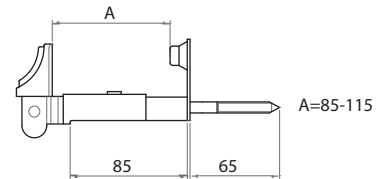

15

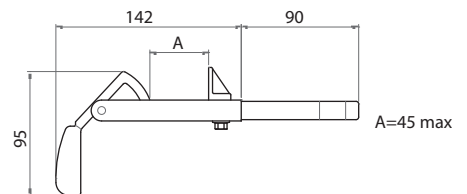
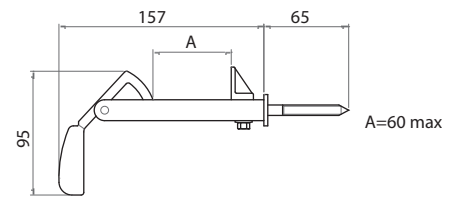

16

	FN	FZT	FZTN	Conf. Pz.
OMETTO MODER VITE TAS Ometto moderno con vite e tassello Shutter stop		33030250006	33032250007	20
OMETTO MODER VITE TAS DOP Ometto moderno con vite e tassello doppio Shutter stop		33030255006	33032255007	20
FERMAIMP VITE REG Fermaimposte con vite regolabile shutter stop	33031055005	33031055006		15
FERMAIMP ZANCA REG Fermaimposte con zanca regolabile shutter stop	33031005005	33031005006		15
FERMAIMP REG MM.105 VITE C/MOLLA Fermaimposte corto con vite regolabile con molla shutter stop		33031052006	33031052007	20
FERMAIMP REG. MM.125 VITE C/MOLLA Fermaimposte corto con zanca regolabile con molla shutter stop		33031051006	33031051007	15

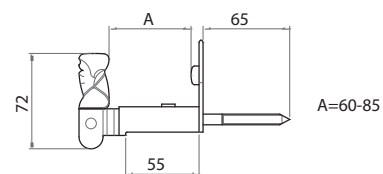
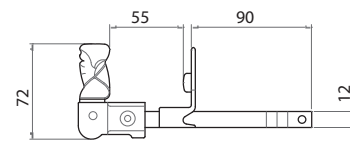

	FN	FZT	FZTN	Conf. Pz.
OMETTO FERMO ZANCA EC Ometto con fermo e zanca economico Shutter stop	33030140005			20
OMETTO FERMO VITE EC Ometto con fermo e vite economico Shutter stop	33030190005			20
OMETTO BIG FOGL REG VITE TAS Ometto BIG regolabile con foglia vite tasello Shutter stop		33030270006	33030270007	20
OMETTO BIG FOGL REG VITE TAS DOP Ometto BIG regolabile con foglia vite tasello doppio Shutter stop		33030275006	33030275007	20

# 12

## Metalmecc





	ZMN	Conf. Pz.
Q8 MM25 C/V Guarnitura Q8x25 con vite in testa Lever handle 8x25mm with screw	66970000016	10
Q8 MM35 C/V Guarnitura Q8x35 con vite in testa Lever handle 8x35mm with screw	66970035016	10
Q8 MM40 C/V Guarnitura Q8x40 con vite in testa Lever handle 8x40mm with screw	66970040016	10
Q8 MM45 C/V Guarnitura Q8x45 con vite in testa Lever handle 8x45mm with screw	66970045016	10
Q8 MM50 C/V Guarnitura Q8x50 con vite in testa Lever handle 8x50mm with screw	66970050016	10
Q8 MM60 C/V Guarnitura Q8x60 con vite in testa Lever handle 8x60mm with screw	66970060016	10
Q8 MM70 C/V Guarnitura Q8x70 con vite in testa Lever handle 8x70mm with screw	66970070016	10
Q8 MM80 C/V Guarnitura Q8x80 con vite in testa Lever handle 8x80mm with screw	66970080016	10

# TORCIGLIONE

FERRO

489



Q8 C/V  
TORCIGLIO.Q8 C/V  
Pair of lever handle with 1 screw visible

ZMN	Conf. Pz.
66974000016	10

# ZAMPA

FERRO



Q8 RP SPINATA  
ZAMPA Q8 SP40 R  
Lever handle 8mm on small rose fixed

ZMN	Conf. Pz.
66982000016	10

# MANIGLIETTE FISSE

FERRO



	ZMN	Conf. Pz.
MAN FISSA SAG MM150 MANIGL. FISSA SAG 150 Fixed handle mm.150	66912150016	10

# MANIGLIETTE FISSE

FERRO



	ZMC	Conf. Pz.
MAN FISSA SCANN MM100 MAN.FISSA SCANN.MM100 Fixed handle mm.100	66912010003	10
MAN FISSA SCANN MM120 MAN.FISSA SCANN.MM120 Fixed handle mm.120	66912012003	10
MAN FISSA SCANN MM140 MAN.FISSA SCANN.MM140 Fixed handle mm.140	66912014003	10
MAN FISSA SCANN MM160 MAN.FISSA SCANN.MM160 Fixed handle mm.160	66912016003	10



---

MAN BLOCCO	ZTR	MEC	Conf.
SAP MAN BLOCCO	66900000006	66900000016	Pz.
Handle			10

---



# 13

**Espositori**

**Display units**



# ESPOSITORE FREESTANDING

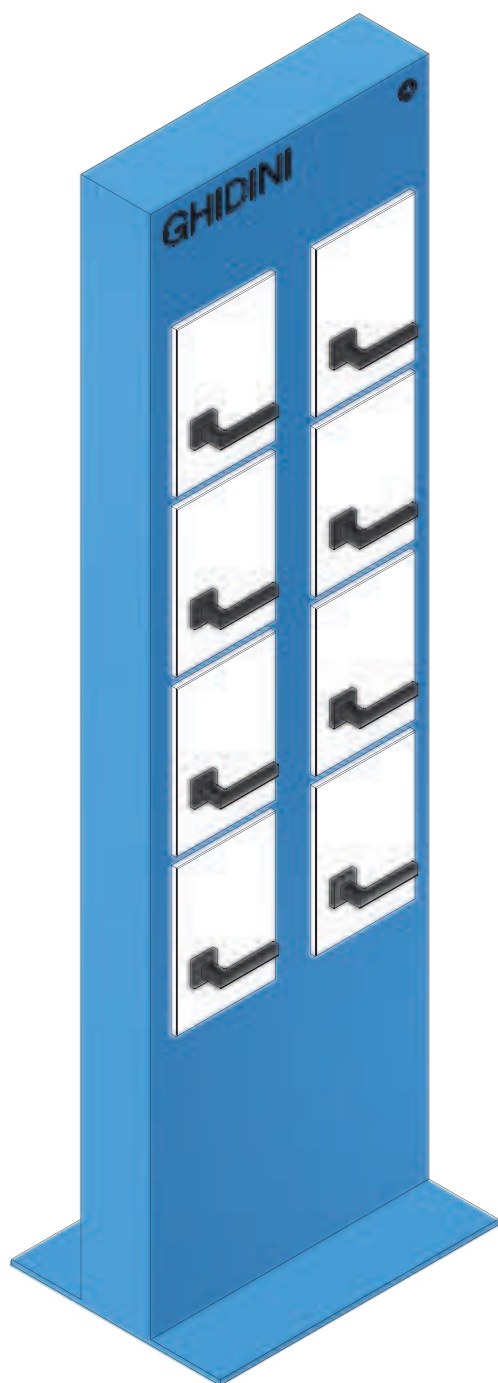

ESPOSIT. TOTEM DOPPIA COLONNA  
16 pannelli H.210 -L.60

Conf.  
Pz.  
19005526000

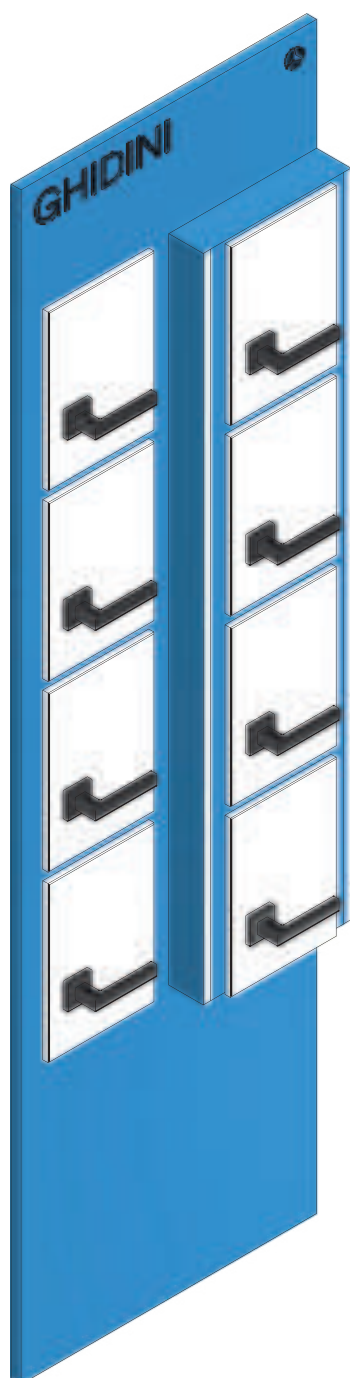

ESPOSIT. PARETE  
8 pannelli H.210 - L 60

Conf.  
Pz.  
19005301100

INSERTO PER PANNELLI LED

19005700700



ESPOSIT. PARETE  
12 pannelli H.210 - L.90

Conf.  
Pz.  
19005301000

INSERTO PER PANNELLI LED

19005700700

# ESPOSITORE DA BANCO



ESPOSITORE DA BANCO BASE RETT  
PANNELLO 315X215 BASE 215X110

Conf.  
Pz.  
19005701000

# PANNELLO SINGOLO

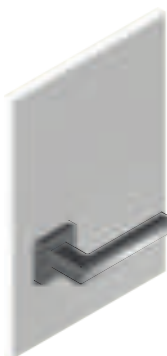

PANNELLO CON FRESATE POSTERIORI  
mm 215x315x14 BIANCO

Conf.  
Pz.  
19005401500

# BAULETTO FINITURE GALATTICHE



ESPOSITORE A BAULETTO  
7900 "FINITURE GALATTICHE"

Conf.  
Pz.  
19005600300

ESPOSITORE A BAULETTO  
141 "FINITURE GALATTICHE"

19005600400

# 14

**Approfondimenti**

**In-depth study**

500	Riepilogo finiture / Finishing summary
501	Resistenza alla corrosione / Corrosion resistance
502	Ghi.co.tec
504	G-Plus
506	Avvertenze / Warnings
508	Condizioni Generali di Vendita / General Terms and Conditions of Sales
514	Contatti



# Riepilogo Finiture

## Finishing summary

MATERIALE	SIGLIA	DESCRIZIONE FINITURA
MATERIAL	ACRONYM	FINISH DESCRIPTION
ottone brass	<b>OANT</b>	ottone brunito anticato <i>antiqued bronzed brass</i>
ottone brass	<b>OLD</b>	ottone anticato naturale <i>antiqued natural brass</i>
ottone brass	<b>ONL</b>	ottone nichel lucido <i>polished nickel brass</i>
ottone brass	<b>OL</b>	ottone lucido <i>polished brass</i>
ottone brass	<b>OLV</b>	ottone lucido verniciato <i>polished painted brass</i>
ottone brass	<b>OCS</b>	Cromo satinato <i>satin chrome</i>
ottone brass	<b>OCL</b>	Cromo lucido <i>polished chrome</i>
ottone brass	<b>ONS</b>	nichel satinato <i>satin nickel</i>
ottone brass	<b>OGV</b>	ottone graffiato verniciato <i>scratched paintedbrass</i>
ottone brass	<b>OS</b>	ottone satinato verniciato <i>brushed brass</i>
ottone brass	<b>OLS</b>	ottone lucido e satinato <i>brushed polished brass</i>
ottone brass	<b>OTTONE RAL</b>	ral verniciati <i>painted ral</i>
ottone brass	<b>OBR</b>	ottone brunito <i>bronzed brass</i>
ottone brass	<b>OFA</b>	ottone nichelato brunito vibrato verniciato <i>old iron brass</i>
ottone brass	<b>OF</b>	ottone brunito lucidato verniciato <i>brass fumè</i>
ottone brass	<b>GPLUS</b>	ottone lucido pvd <i>polished brass with physical vapour depostion treatement</i>
zama zamak	<b>ZCL</b>	Cromo lucido <i>polished chrome</i>
zama zamak	<b>ZCS</b>	Cromo satinato <i>satin chrome</i>
zama zamak	<b>ZGV</b>	graffiato bronzato verniciato lucido <i>scratched bronzed polished painted</i>
zama zamak	<b>ZNS</b>	nichel satinato <i>satin nickel</i>
zama zamak	<b>ZAMA RAL</b>	ral verniciati <i>painted ral</i>
zama zamak	<b>ZNO</b>	nero verniciato <i>black painted</i>
zama zamak	<b>GCTOL</b>	ottonato lucido GHICOTEC <i>polished brass GHICOTEC</i>
zama zamak	<b>TITANIUM</b>	titanio <i>titanium</i>
zama zamak	<b>Z-BGO</b>	brunito graffiato opaco <i>burnished scratched matte</i>
zama zamak	<b>Z-OSO</b>	ottone satinato opaco <i>matte satin brass</i>
zama zamak	<b>ZBR</b>	brunito verniciato opaco <i>burnished matte painted</i>
zama zamak	<b>BORGOGNA</b>	brunito graffiato verniciato opaco <i>burnished scratched matte painted</i>
zama zamak	<b>CHAMPAGNE</b>	brunito sfumato verniciato opaco su base oro <i>burnished shaded matte painted on gold base</i>
zama zamak	<b>LORENA</b>	brunito verniciato opaco <i>burnished matte painted</i>
zama zamak	<b>NORMANDIA</b>	brunito sfumato verniciato opaco su base argento <i>burnished shaded matte painted on silver base</i>

alluminio aluminium	<b>F1</b>	argento <i>silver</i>
alluminio aluminium	<b>F3</b>	oro <i>gold</i>
alluminio aluminium	<b>F4</b>	bronzo <i>bronze</i>
alluminio aluminium	<b>F9</b>	inox <i>inox</i>
alluminio aluminium	<b>F1-SAT</b>	argento satinato <i>satin silver</i>
alluminio aluminium	<b>JUPITER</b>	bronzo satinato <i>satin bronze</i>
alluminio aluminium	<b>MERCURY</b>	argento satinato <i>satin silver</i>
alluminio aluminium	<b>SPACE</b>	nero satinato <i>satin black</i>
alluminio aluminium	<b>URANUS</b>	inox satinato <i>satin inox</i>
alluminio aluminium	<b>ACL</b>	Cromo lucido <i>polished chrome</i>
alluminio aluminium	<b>ACS</b>	Cromo satinato <i>satin chrome</i>
alluminio aluminium	<b>ALLUMINIO RAL</b>	ral verniciati <i>painted ral</i>
alluminio aluminium	<b>ANO</b>	nero verniciato <i>black painted</i>
alluminio aluminium	<b>ACP</b>	Cromo perla <i>pearl chrome</i>
alluminio aluminium	<b>GCTOL</b>	oro lucido GHICOTEC <i>polished gold GHICOTEC</i>
alluminio aluminium	<b>GCTCL</b>	Cromo lucido GHICOTEC <i>polished chrome GHICOTEC</i>
alluminio aluminium	<b>GCTOS</b>	oro satinato GHICOTEC <i>satin gold GHICOTEC</i>
alluminio aluminium	<b>GCTCS</b>	Cromo satinato GHICOTEC <i>satin chrome GHICOTEC</i>
alluminio aluminium	<b>GCTNS</b>	nichel satinato GHICOTECH <i>satin nickel GHICOTECH</i>
alluminio aluminium	<b>ACH</b>	argento verniciato <i>silver painted</i>
nylon nylon	<b>NAM</b>	amaranto <i>amaranth</i>
nylon nylon	<b>NBI</b>	bianco <i>white</i>
nylon nylon	<b>NGI</b>	giallo <i>yellow</i>
nylon nylon	<b>NGR</b>	grigio <i>grey</i>
nylon nylon	<b>NMA</b>	marrone <i>brown</i>
nylon nylon	<b>NNE</b>	nero <i>black</i>
nylon nylon	<b>NRO</b>	rosso <i>red</i>
nylon nylon	<b>NVE</b>	verde <i>green</i>

# Resistenza alla corrosione

## Corrosion resistance

### Resistenza alla corrosione in riferimento alle norme UNI EN ISO 9227 EN 1670:2007

La norma specifica i requisiti di resistenza alla corrosione degli accessori per porte, finestre, chiusure oscuranti e facciate continue. Si applica anche agli elementi di collegamento metallico richiesti per il fissaggio degli accessori per serramenti.

### Corrosion resistance according to UNI EN ISO 9227 EN 1670:2007

The standard specifies the corrosion resistance requirements for accessories for doors, windows, shutters, and curtain walls. It also applies to the metal connecting elements required for securing the window fittings.

MATERIALE MATERIAL	SIGLIA ACRONYM	DESCRIZIONE FINITURA FINISH DESCRIPTION	24+1 ore in nebbia salina	48+1 ore in nebbia salina	96+1 ore in nebbia salina	240+1 ore in nebbia salina	480+1 ore in nebbia salina
			<i>low corrosion resistance</i>	<i>moderate corrosion resistance</i>	<i>high corrosion resistance</i>	<i>very high corrosion resistance</i>	<i>exceptionally corrosion resistance</i>
			GRADO CLASSE 1	GRADO CLASSE 2	GRADO CLASSE 3	GRADO CLASSE 4	GRADO CLASSE 5
			GRADE CLASS 1	GRADE CLASS 2	GRADE CLASS 3	GRADE CLASS 4	GRADE CLASS 5
ottone brass	OLV	ottone lucido verniciato <i>polished painted brass</i>	x				
ottone brass	OCS	cromo satinato <i>satin chrome</i>				x	
ottone brass	OCL	cromo lucido <i>polished chrome</i>					x
ottone brass	ONS	nicel satinato <i>satin nickel</i>			x		
ottone brass	OGV	ottone graffiato verniciato <i>scratched painted brass</i>	x				
ottone brass	OS	ottone satinato verniciato <i>brushed brass</i>	x				
ottone brass	OLS	ottone lucido e satinato <i>brushed polished brass</i>	x				
ottone brass	OTTONE RAL	ral verniciati <i>painted ral</i>					x
ottone brass	OBR	ottone brunito <i>bronzed brass</i>				x	
ottone brass	OFA	ottone nichelato brunito vibrato verniciato <i>old iron brass</i>					x
ottone brass	OF	ottone brunito lucidato verniciato <i>brass fumè</i>		x			
ottone brass	GPLUS	ottone lucido pvd <i>polished brass with physical vapour deposition treatment</i>					x
zama zamak	ZCL	cromo lucido <i>polished chrome</i>					x
zama zamak	ZCS	cromo satinato <i>satin chrome</i>			x		
zama zamak	ZNS	nicel satinato <i>satin nickel</i>			x		
zama zamak	ZAMA RAL	ral verniciati <i>painted ral</i>				x	
zama zamak	ZNO	nero verniciato <i>black painted</i>				x	
zama zamak	GCTOL	ottone lucido GHICOTEC <i>polished brass GHICOTEC</i>					x
alluminio aluminium	F1	argento <i>silver</i>					x
alluminio aluminium	F3	oro <i>gold</i>					x
alluminio aluminium	F4	bronzo <i>bronze</i>					x
alluminio aluminium	F9	inox <i>inox</i>					x
alluminio aluminium	F1-SAT	argento satinato <i>satin silver</i>					x
alluminio aluminium	JUPITER	bronzo satinato <i>satin bronze</i>					x
alluminio aluminium	MERCURY	argento satinato <i>satin silver</i>					x
alluminio aluminium	SPACE	nero satinato <i>satin black</i>					x
alluminio aluminium	URANUS	inox satinato <i>satin inox</i>					x
alluminio aluminium	ACL	cromo lucido <i>polished chrome</i>				x	
alluminio aluminium	ACS	cromo satinato <i>satin chrome</i>			x		
alluminio aluminium	ALLUMINIO RAL	ral verniciati <i>painted ral</i>					x
alluminio aluminium	ANO	nero verniciato <i>black painted</i>					x
alluminio aluminium	ACP	cromo perla <i>pearl chrome</i>			x		
alluminio aluminium	GCTOL	oro lucido GHICOTEC <i>polished gold GHICOTEC</i>					x
alluminio aluminium	GCTCL	cromo lucido GHICOTEC <i>polished chrome GHICOTEC</i>					x
alluminio aluminium	GCTOS	oro satinato GHICOTEC <i>satin gold GHICOTEC</i>			x		
alluminio aluminium	GCTCS	cromo satinato GHICOTEC <i>satin chrome GHICOTEC</i>			x		
alluminio aluminium	GCTNS	nicel satinato GHICOTECH <i>satin nickel GHICOTECH</i>			x		

Nel 1995 entra in funzione il nuovo impianto per il trattamento denominato GHI.CO.TEC., Ghidini Coating Technology, un nuovo modo di concepire protezione e colorazione di maniglie e coordinati in ottone, Zama, alluminio.

Mediante un processo di cataforesi GHI.CO.TEC. deposita sul metallo resine che aderiscono ad esso per azione di un campo elettrico che si genera nelle vasche in cui i pezzi vengono immersi; con un successivo passaggio a forno la resina si indurisce ed il pezzo assume l'aspetto definitivo. La resina di base è trasparente ed incolore, ma con l'aggiunta di pigmenti potrebbe assumere qualsiasi colorazione. nel nostro caso utilizziamo la protezione incolore su ottone lucidato e quella "gialla" su zama ed alluminio.

Per l'ottone, GHI.CO.TEC., è dunque un'alternativa alla tradizionale verniciatura trasparente. Mentre per zama ed alluminio in un unico passaggio, il pezzo si colora, assumendo il tono dell'ottone, e si protegge dall'ossidazione e dall'usura con un deposito diretto sul metallo di base. Il rivestimento ha uno spessore assolutamente uniforme e garantisce caratteristiche di resistenza ad usura e ossidazione superiori a quanto ottenibile con i trattamenti tradizionali.

Da non trascurare l'aspetto ecologico del processo che lavora completamente a ciclo chiuso, quindi senza scarichi nell'ambiente e senza sviluppo di fumi o sostanze nocive per gli operatori.

In 1995 the new plant for the GHI.CO.TEC., Ghidini Coating Technology, started working.

This new plant is a new way to conceive protection and colouring of brass, zamak or aluminium handles and coordinates.

By means of a cataphoresis process, GHI.CO.TEC. deposits resins on metal and they adhere to it through an electric field which is generated in the bath tank where the pieces are dipped; with a further kiln step, the resin hardens and the piece takes the definite look.

The basic resin is transparent and colourless, but adding pigments, it can acquire any sort of colour. In our case we use a colourless protection on polished brass and a “yellow” protection on zamak or aluminium.

As far as brass is concerned, GHI.CO.TEC. is therefore a great change to the traditional transparent coating. Instead of treating zamak and aluminium with the usual brass coating galvanized system, with a single GHI.CO.TEC. operation, it is possible to colour the article and at the same time give it the right protection from oxidation.

The coating is absolutely uniform as far as the thickness is concerned and guarantees those characteristics of hardness, adhesion, resistance to solvents and to corrosion in saline fog, with better results compared to those which could be reached by means of traditional treatments.

The ecological aspect has to be taken into account as well, being the process a closed cycle, therefore no emissions in the environment, no fumes or dangerous substances for the operators are developed.

## **G-PLUS**

Ghidini group, proseguendo la propria ricerca che tende ad offrire i migliori caratteri tecnici e formali, presenta G-PLUS: il più aggiornato sviluppo della tecnologia PVD (Physical Vapour Deposition) applicata alle maniglie ed ai coordinati. Superficie dura e compatta, grande resistenza alle abrasioni ed alle aggressioni atmosferiche ed un piacevolissimo colore vivo dell'ottone sono i caratteri che distinguono G-PLUS.

G-PLUS realizza rivestimenti ad elevate caratteristiche mediante condensazione sotto vuoto sulla base da rivestire di vapori ottenuti con fattori fisici.

G-PLUS prevede una reazione fisica tra ioni di zirconio. Sche si depositano sulla base in ottone precedentemente nichelata e cromata.

La generazione dei vapori avviene per effetto di una scarica ad arco sotto vuoto tra un catodo, ovvero la sorgente dei vapori stessi e la camera in cui avviene l'intero processo.

Le maniglie ed i coordinati trattati con G-PLUS godono di caratteristiche ampiamente superiori rispetto a quanto possibile con tutti i trattamenti tradizionali. Prendendo come termine di confronto la cromatura galvanica otteniamo:

G-PLUS ha superato severi test di laboratorio che ci consentono di certificare:

- Aderenza 100% secondo la normativa UNI-ISO 4524/5
- Nessuna alterazione dopo 1000 ore di prova accelerata di resistenza alla luce secondo la normativa UNI 9397
- Nessun intacco da parte di acido cloridrico, solforico, nitrico, ossalico, acetico e citrico, soda e potassa caustica, cianuri e sgrassature alcaline a caldo.

I risultati di protezione del trattamento G-PLUS permettono, anche ai clienti più esigenti, di ottenere maniglie e coordinati con una superficie di durezza paragonabile all'acciaio, resistenza agli agenti atmosferici che ne permette l'uso anche in esposizioni esterne in ambienti aggressivi, brillantezza del colore dell'ottone grazie alla protezione inalterabile nel tempo, garanzia illimitata perchè la protezione offerta supera anche i limiti di garanzia previsti per legge.

## G-PLUS

Carrying on their research in order to offer the best technical and formal features, GHIDINI group are presenting G-PLUS: the most up to date technological development: PVD (Physical Vapour Deposition) applied to handles and co-ordinates. Hard and compact surface, great abrasion proof, atmospheric aggression resistant and a very pleasant vivid brass colour are the features which distinguish G-PLUS.

G-PLUS is the result of the most innovative deposition technique PVD, by means of which it is possible to carry out coatings having high features through vacuum condensation of vapours obtained with physical factors on the surface to be coated. In the G-PLUS case, a physical reaction among zirconium ions (ZrN) which are deposited on the brass surface previously nickel and chromium plated is foreseen. The vapours are originated by means of vacuum discharge pressure between a cathode, that is the source of vapours and the chamber in which the entire process takes place. The handles and coordinates treated with G-PLUS have characteristics which are vastly superior compared to what obtainable by means of traditional treatments. G-PLUS underwent severe laboratory tests which allow us to certify:

G-PLUS underwent severe laboratory tests which allow us to certify:

- 100% adhesion according to UNI-ISO 425415 Norm.
- No alterations after a 1000 hour accelerated resistance to light test according to UNI 9397 norm.
- No indentation was caused by using hydrochloric, sulphuric, nitric, oxalic, acetic and citric acids, caustic soda and potassium hydroxide, cyanide and alkaline and hot degreasing.

The protective results of G-PLUS treatment allow, even to the most demanding customers, to obtain handles and coordinates with a hardened surface which can be compared to steel, which is resistant to external atmospheric agents and which can be placed externally even in saline fog. Thanks to the inalterability of protection, the brass colour brightness doesn't change and an unlimited guarantee due to protection which goes even beyond the limit guarantee foreseen by the law. G-PLUS a protection unlimited guaranteed for people who want beautiful long lasting handles.

## PRECAUZIONI PER INSTALLATORI ED UTILIZZATORI FINALI

**Protezione dall'acido tannico:** nelle finestre e porte-finestre in legno di rovere o altre essenza con un elevato contenuto di tannino, assicurarsi che questo non possa evaporare dal legno. La guarnitura non deve avere contatto diretto con una superficie del legno non trattato.

**Protezione da sigillante:** non utilizzare mai sigillanti a reticolazione acetica o contenenti altre sostanze aggressive, ad esempio acido formico o acetico, composti di ammoniaca, aldeide, fenoli, cloro, tannino ecc., perché sia il contatto diretto con il sigillante che i vapori di queste sostanze possono aggredire la superficie dei particolari.

**Durante i lavori in genere, demolizione, ristrutturazione, realizzazione di intonaci e tinteggiatura, riparare le guarniture (comunque tutti i nostri prodotti) dal contatto con polveri, calce, intonaco, tempere e smalti vari. Fare aerare bene il locale prima di togliere le protezioni, il consiglio se possibile sarebbe di montare le guarniture dopo aver eseguito i lavori e dopo essersi assicurati che il locale sia stato ben aerato.**

**Pulizia e protezione da detergenti aggressivi contenenti acidi:** pulire le guarniture esclusivamente con panno morbido e detergenti a pH neutro diluito. Non usare mai detergenti o abrasivi aggressivi contenenti acidi. Questi potrebbero danneggiare le guarniture.

**La non osservanza delle suddette indicazioni può causare danni irreparabili al prodotto.**

## PRECAUTIONS FOR INSTALLATION AND CONSUMERS

**Tannic acid protection:** in the windows and glass doors in oak or other trees with a high tannin content, make sure that this can not evaporate from the wood.

The crank should not have direct contact with a surface of untreated wood.

**Sealant protection:** Do not use any sealant acetic or other aggressive substances such as formic acid, acetic acid, ammonia compounds, aldehyde, phenol, chlorine, tannin etc., for a direct contact with the sealant, the vapors of these substances can damage the finishings of the products.

During general maintenance, demolition, renovation, plastering and painting, repairing the cranks (though all of our products) from contact with dust, lime, plaster, tempera and various glazes.

Make sure the rooms are ventilated enough before removing the protections. The best advice if possible is to mount the cranks after performing other works and after making sure that the premises was well aerated.

**Cleaning and protection from detergents containing acids:** clean the cranks only with soft cloth and neutral pH detergent diluted. Never use harsh or abrasive cleaners containing acids.

These could damage the crank.

The non-observance of these instructions may cause irreparable damage to the product.



# Condizioni Generali di Vendita

## **PREZZI:**

Il prezzo di listino è riferito a N°1 pezzo dell'articolo con codice ad esso riferito IVA esclusa con resa franco partenza e imballo quantificato nella misura del 1% dell'imponibile in fattura.

## **SPEDIZIONI:**

La merce viaggia in ogni caso a rischio e pericolo del committente. In assenza di precise istruzioni circa il mezzo di inoltro della merce le spedizioni sono eseguite nel modo ritenuto più idoneo ed economico senza nessuna responsabilità della Casa.

## **PAGAMENTI:**

Devono essere effettuati direttamente al domicilio della nostra sede o mediante estinzione di nostre ricevute bancarie entro la scadenza concordata. Eventuali ritardi comportano il conteggio degli interessi di mora.

## **ORDINI:**

Tutti gli ordini devono essere inoltrati ai nostri agenti di zona utilizzando codici e descrizioni corrette di quanto richiesto. Eventuali ordini inviati direttamente alla nostra sede sono accettati solo se trasmessi a mezzo telefax e completi di codici e descrizioni corretti di quanto richiesto. Ogni articolo richiesto in quantità inferiore al numero di pezzi previsti nella confezione standard subirà un aumento prezzo del 10%. Tutti gli ordini, in ogni caso, sono subordinati all'approvazione della Casa.

## **FATTURAZIONE:**

Il minimo importo netto merce fatturabile è di € 200,00.

## **TERMINI DI CONSEGNA:**

Il termine di consegna e di spedizione, anche se confermato, costituisce una semplice previsione ed ha perciò un valore indicativo, quindi non comporta nessuna garanzia e nessun indennizzo è dovuto per la mancata consegna nel termine previsto.

**ARTICOLI:**

Tutti gli articoli presentati con il precedente Listino Illustrato 2012, ma non citati in questa edizione sono usciti di produzione, pertanto eventuali ordini in corso saranno evasi fino ad esaurimento delle scorte. Ogni variante rispetto agli articoli a listino è da considerarsi prodotto speciale per il quale, di volta in volta, è necessario richiedere fattibilità, quantità minima, prezzo. La fornitura di prodotti speciali a richiesta è subordinata all'accettazione da parte del committente della relativa conferma d'ordine. La Casa si riserva il diritto di approvare modifiche agli articoli e variazione dei prezzi senza preavviso.

**RESI:**

Non si accettano resi di merce standard, se non espressamente autorizzati dalla Casa. Le contestazioni, comunque, devono essere fatte entro 8 giorni dal ricevimento della merce. Le richieste di reso devono pervenire a mezzo fax, verranno analizzate ed eventualmente autorizzate mediante apposita "Scheda di Autorizzazione Reso" indicante tutte le modalità e condizioni alle quali verrà accettato il reso. Qualsiasi reso pervenuto senza preavviso ed autorizzazione verrà respinto al mittente. Per prodotti speciali approntati a richiesta non si accettano resi per alcun motivo. Per qualsiasi controversia è competente il Foro di Brescia. La fornitura di prodotti speciali a richiesta è subordinata all'accettazione da parte del committente della relativa conferma d'ordine. La Casa si riserva il diritto di approvare modifiche agli articoli e variazione dei prezzi senza preavviso.

# General Terms and Conditions of Sales

## **ORDERS:**

All direct and indirect Orders are subject to our approval and cannot be revoked by the Buyer.

## **DELIVERIES:**

The delivery terms are approximate. In case of delays in the execution of an Order or partial shipments, the Seller will not be liable for damages.

## **SHIPMENTS:**

Even if the goods are supplied free destination, they are forwarded at the exclusive risk of the Buyer who is obliged to collect them. In case of non-collection the damages ensuing from this will be entirely at the Buyer's expense.

## **CLAIMS:**

No claims can be considered unless made within seven days of delivery of the goods. In case of a recognized imperfection of the product, it will be replaced, on the understanding that it has not been put into use.

## **PAYMENTS:**

All payments must be made within the terms agreed upon and exclusively to our domicile. In case of delays the Seller will be entitled to a Credit Surcharge of three percent above the official interest rate. Discounts or deductions are not accepted, unless previously authorized.

## **JURISDICTION:**

For any controversy the only competent instance is the Court of Justice of Brescia.







# GHIDINI

Ghidini Pietro Bosco Srl  
Via Pietro Ghidini 32/34  
25060 Brozzo di Marcheno  
(BS) Italia  
P.iva 00553110982

[info@ghidini.com](mailto:info@ghidini.com)  
+3903089691

[ghidini.com](http://ghidini.com)