

CRISTALDESIGN  
VISIONI 

GRUPPO  
AIP  
PORTE NEL TEMPO 





CRISTALDESIGN  
**VISIONI** 



Scansiona il QR Code presente nelle prossime pagine per accedere a contenuti extra.  
*Scan the QR Code on the following pages to access additional content.*



## **DESTINAZIONI SORPRENDENTI**

Le novità di questo catalogo .....8



## **IL VETRO IN MOVIMENTO**

Tutti i sistemi di apertura .....22



## **IL VETRO OLTRE I SUOI CONFINI**

Interazioni del vetro con altri materiali ..... 106



## **IL VETRO ED I COLORI**

Tutte le cromie e lavorazioni disponibili ..... 130



## **L'INCONTRO DI DUE MONDI**

Modelli coordinati con altre collezioni ..... 162

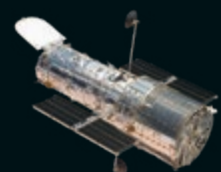

## **IL VETRO NELLA SUA ESSENZA**

Sezione tecnica riepilogativa ..... 176



# IL NOSTRO PIANETA

Visioni trasforma il vetro in porte e strutture, crea un legame con il nostro mondo, combinando produzione di qualità e design moderno per creare uno spazio nuovo in ogni casa.

*Visioni transforms glass into doors and structures, creates a link with our world, combining quality production and modern design to create a new space in every home.*









# PORTE E STRUTTURE IN VETRO, VISIONI D'ITALIA

L'arte e la creatività italiane di Visionsi, il brand di porte e strutture in vetro: ogni pezzo è un'opera d'arte, un'emanazione di stile e qualità Made in Italy, che trasforma gli ambienti con raffinatezza.

*The Italian art and creativity of Visionsi, the brand of glass doors and structures: each piece is a work of art, an emanation of Made in Italy style and quality, which transforms environments with refinement.*







# DESTINAZIONI SORPRENDENTI

Viaggia nel futuro delle porte in vetro con le nostre ultime creazioni.

Innovazione, design d'avanguardia e funzionalità si fondono in un mondo di possibilità senza limiti.

*Travel into the future of glass door art with our latest creations. Innovation, cutting-edge design and functionality come together in a world of limitless possibilities.*









# CANVAS

intreccio  
tra vetro, tessuto  
e alluminio

La stoffa all'interno del vetro, per personalizzare le proprie porte con un design unico ed originale. Cinque trame e colori differenti, abbinare ad un vetro extrachiaro, capace di adattarsi ad un design ricercato ed unico.

## CANVAS INTERWEAVING OF GLASS, FABRIC AND ALUMINIUM

*The fabric inside the glass, to personalize your doors with a unique and original design. Five different textures and colours, combined with extra-clear glass, capable of adapting to a refined and unique design.*







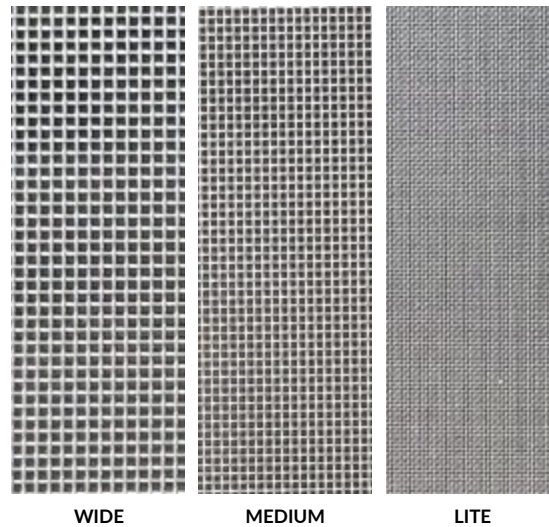
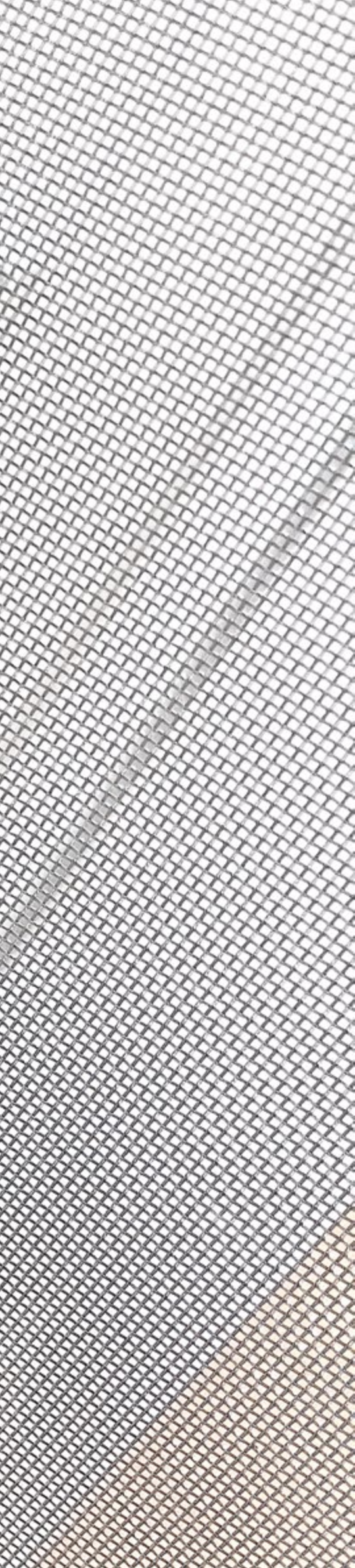

## CONNECTION

una rete  
di riflessi per  
un vetro unico

La serie di vetri "Connection" ha un cuore d'acciaio. Tre reti metalliche con trame differenti, accoppiate ad un vetro extrachiaro, grigio o bronzo, conferiscono alla porta un tocco personale dal design moderno e delicato.

AN INTERCONNECTED NETWORK  
IN TRANSPARENCY, A UNIQUE GLASS

*The "Connection" glass series has a heart of steel. Three metal meshes with different textures, coupled with extra-clear, gray or bronze glass, give the door a personal touch with a modern and delicate design.*





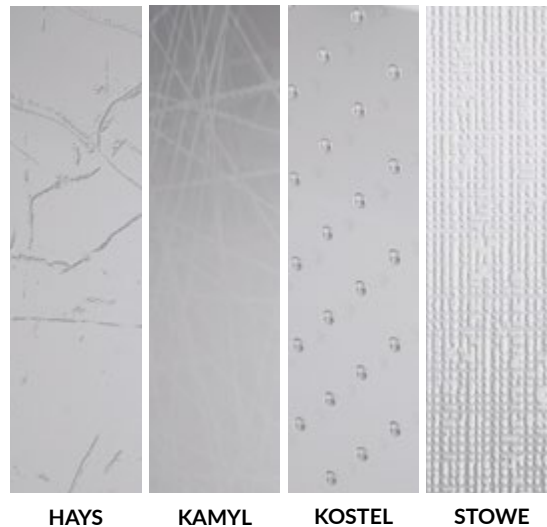

## **MATERICI** l'impronta della materia impressa nel vetro

Una texture appena percepibile,  
delle linee fitte ed irregolari,  
tanti piccoli puntini simmetrici,  
un rilievo geometrico su fondo satinato:  
vetri unici, adatti per chi vuole  
discrezione senza rinunciare alla luce.

### THE IMPRINT OF THE MATERIAL IMPRINTED IN THE GLASS

*A barely perceptible texture, thick and irregular lines, many  
small symmetrical dots, a geometric relief on a satin  
background: unique glass, suitable for those who want  
discretion without giving up light.*









## **WOOD** il legno ridisegnato dal vetro

Porte in vetro eleganti con profili in alluminio e inserti in legno: l'armonia di materiali nobili e modernità, un connubio di stile e funzionalità per ogni ambiente.

### THE WOOD REDESIGNED FROM GLASS

*Elegant glass doors with aluminum profiles and wooden inserts: the harmony of noble materials and modernity, a combination of style and functionality for every environment.*









## **PROFILE** il profilo nella versione a battente

Porte in vetro, profili in alluminio  
sottili come l'eleganza.  
Trasparenza e design si fondono in  
un'incredibile leggerezza, donando  
luce e modernità ai tuoi spazi."

### THE PROFILE IN THE SWING VERSION

*Glass doors, aluminum profiles as thin as elegance.  
Transparency and design come together in an incredible  
lightness, giving light and modernity to your spaces."*







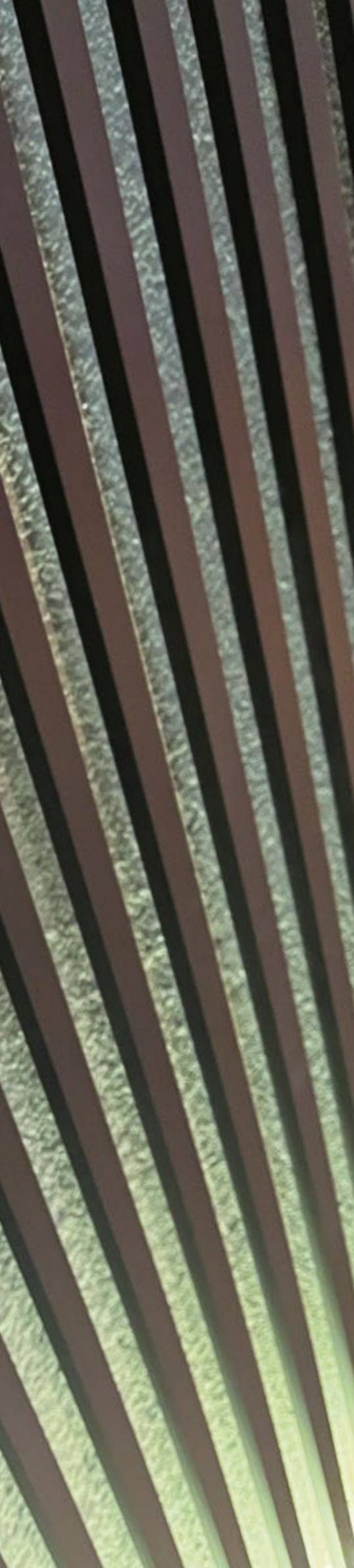

## **INDUSTRIAL** alluminio, vetro e affascinanti geometrie

Porte in vetro con profili in alluminio  
a quadri di ispirazione urbana:  
la fusione tra modernità e design dà  
vita ad interni dall'aspetto distintivo.

### ALUMINIUM, GLASS AND FASCINATING GEOMETRIES

*Glass doors with urban-inspired checked aluminum profiles:  
the fusion between modernity and design gives life to interiors  
with a distinctive look.*

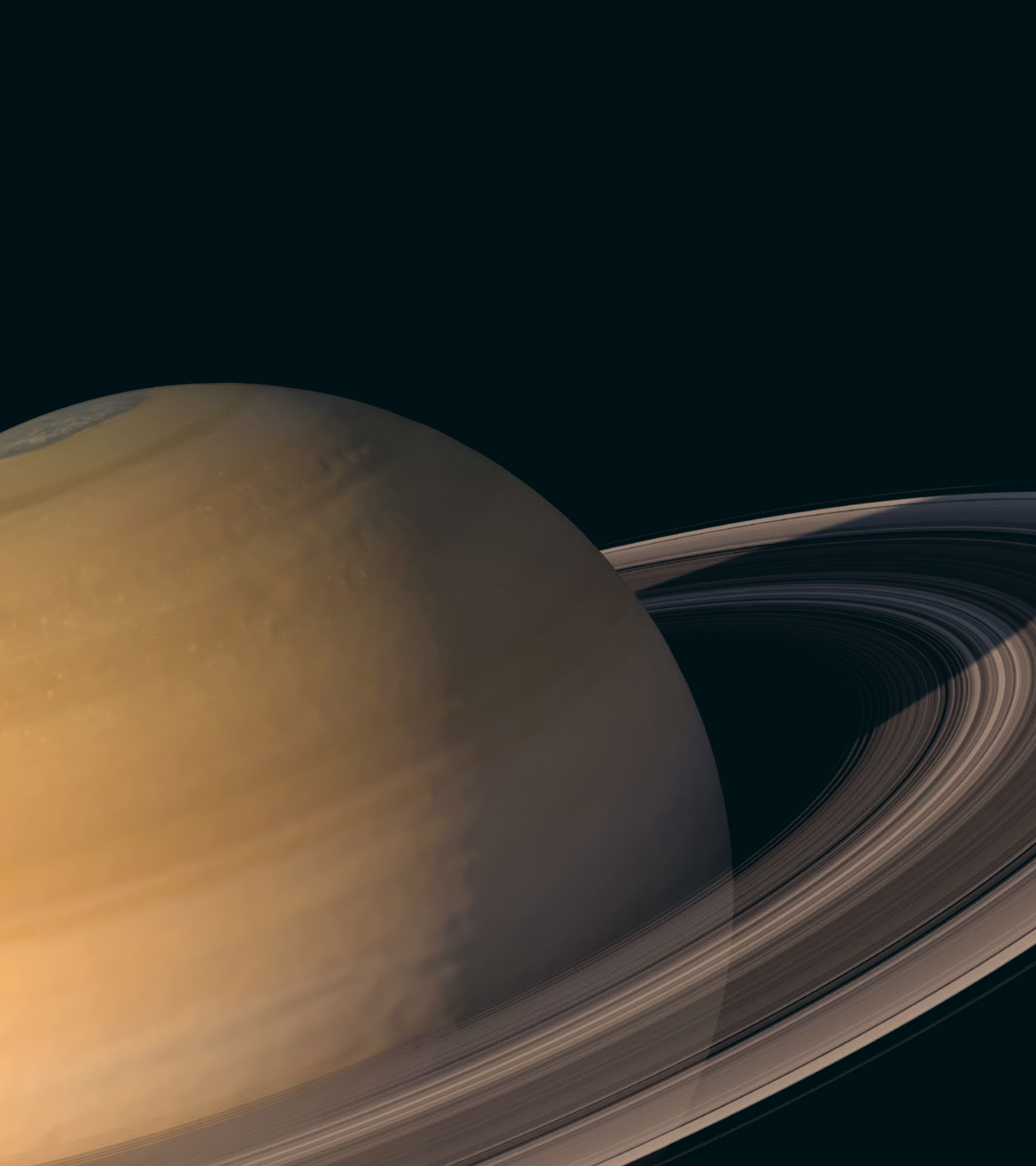



# IL VETRO IN MOVIMENTO

Esplora un mondo di possibilità  
con le nostre porte in vetro:  
dalle scorrevoli interne ed esterne  
alle soluzioni più classiche,  
apri le porte alla tua creatività.

*Explore a world of possibilities with our glass doors:  
from internal and external sliding doors to more classic  
solutions, open the doors to your creativity.*



MAESTRO:  
il sistema di scorrimento  
esterno per porte in vetro  
che unisce l'eleganza  
minimale del design al  
binario silenzioso  
ed affidabile.

MAESTRO:  
*the external sliding  
system for glass doors  
that combines the  
minimal elegance of the  
design with the silent  
and reliable track.*

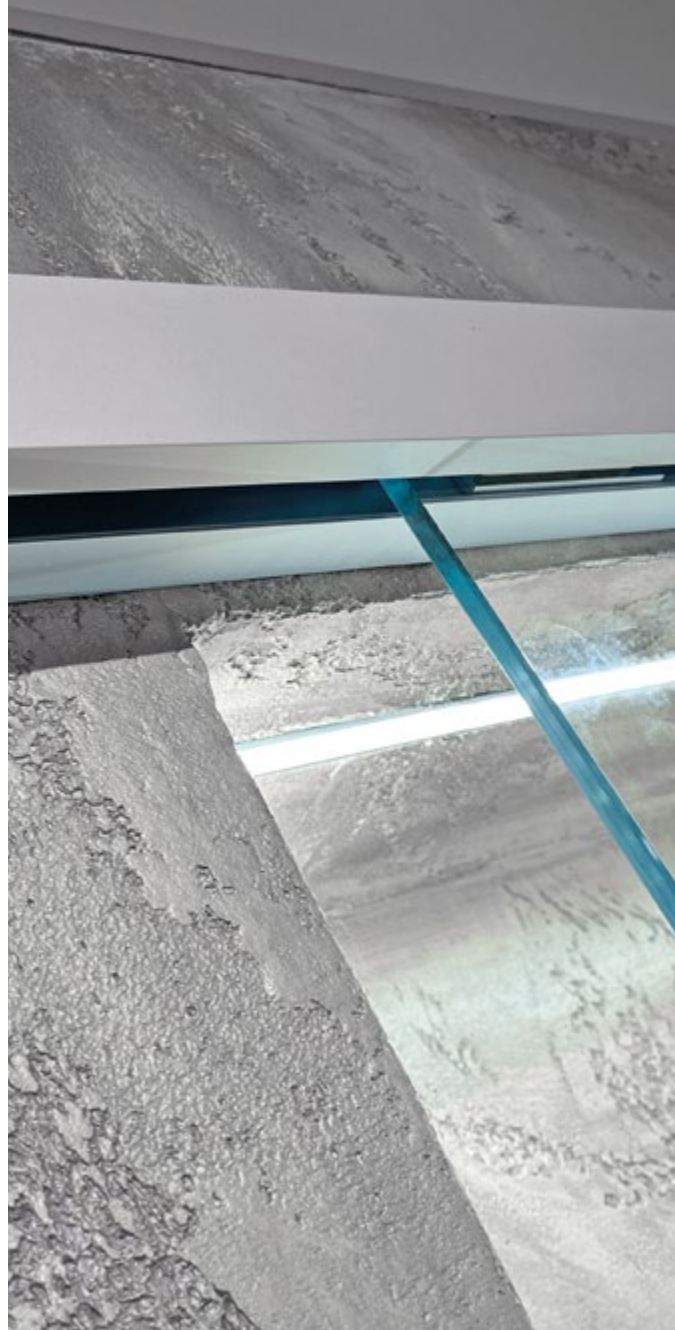

# MAESTRO VISIONI

SCORREVOLE ESTERNO MURO

#### **Visioni**

Porta scorrevole esterno muro  
Vetro trasparente bronzo  
Sistema di scorrimento **Maestro**  
Maniglione MAN-T46

#### **Visioni**

*Sliding door external wall  
Bronze transparent glass  
Maestro flow system  
MAN-T46 pull handle*









**Visioni**  
Porta doppia scorrevole  
opposta esterno muro  
Vetro trasparente extrachiaro  
Sistema di scorrimento **Maestro**  
Maniglione MAN-Q46 alluminio

**Visioni**  
*Double sliding door opposite external wall*  
*Extra-clear transparent glass*  
*Maestro sliding system*  
*MAN-Q46 aluminum pull handle*

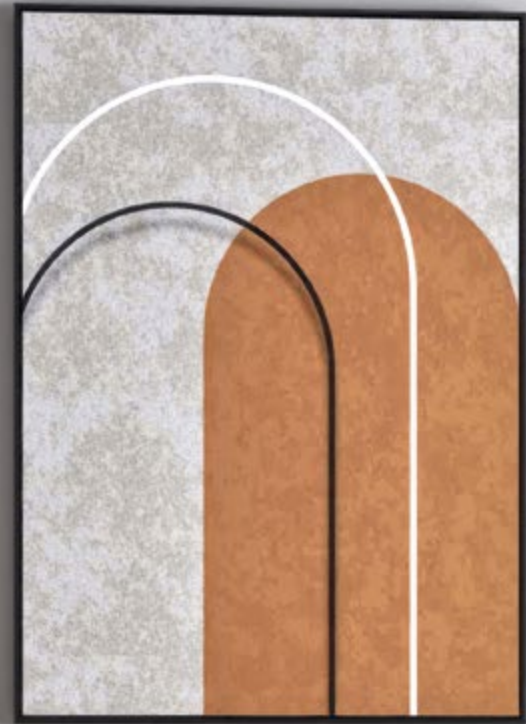







**Visioni**

Porta scorrevole esterno muro  
su anta fissa  
Vetro satinato bronzo  
Sistema di scorrimento **Maestro**

**Visioni**

External wall sliding door  
on fixed leaf  
Bronze satin glass  
Maestro sliding system



# SCORREVOLE ESTERNO MURO MAESTRO

Finiture disponibili



## Caratteristiche tecniche

Portata massima 110 Kg/anta  
Larghezza minima foro muro 400 mm  
Lunghezza massima binario 6000 mm  
Ammortizzato (con limitazioni)

## Technical features

Maximum load 110 Kg/leaf  
Minimum wall opening width 400 mm  
Maximum track width 6000 mm  
Amortized (with limitations)

## Principali versioni disponibili Main versions available

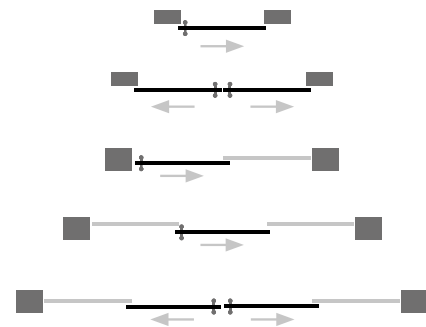

## Passaggio chiuso Passage closed

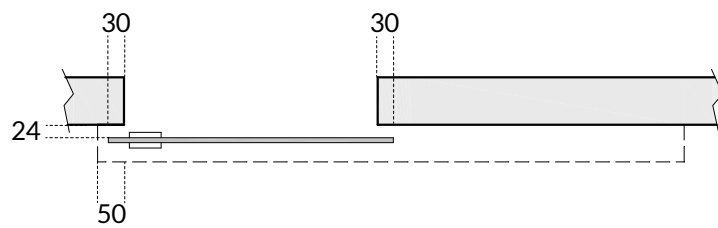

sormonto anta sul muro 30 mm per lato  
distanza anta dal muro 24 mm

door overlap on the wall 30 mm on each side  
door distance from the wall 24 mm

## Apertura totale

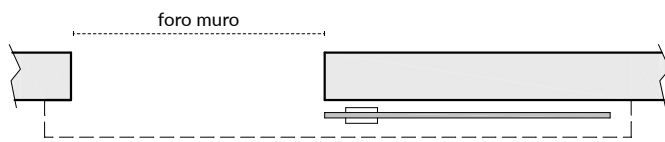

## Apertura parziale

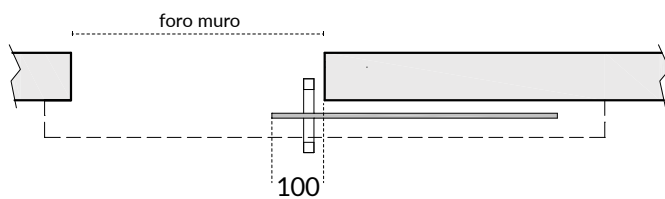

## Fissaggio binario a parete Track fixing to the wall

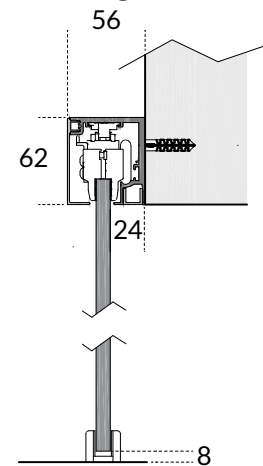

## Fissaggio binario a soffitto Ceiling track fixing

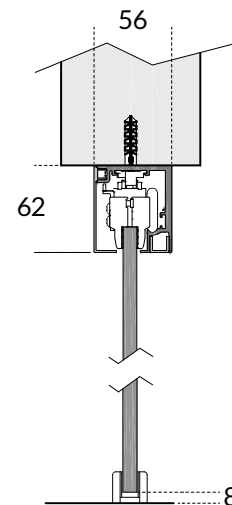

Per ulteriori informazioni tecniche consulta la scheda tecnica sul listino - For further technical information consult the technical data sheet on the price list







ESSENZA:  
il minimalismo  
raggiunge  
l'eccellenza: una  
sottile fessura svela  
l'armoniosa fusione  
tra differenti spazi  
interni.

*ESSENZA:  
the minimalism  
achieves excellence:  
a thin crack reveals  
the harmonious fusion  
between different  
interior spaces.*

# ESSENZA VISIONI

SCORREVOLE ESTERNO MURO

**Visioni**

Porta scorrevole esterno muro  
Vetro trasparente grigio  
Sistema di scorrimento **Essenza**  
Maniglione MAN-T46 inox satinato

**Visioni**

*External wall sliding door  
Gray transparent glass  
Sliding system **Essenza**  
MAN-T46 satin stainless steel pull handle*



**Visioni**  
Porta doppia scorrevole interno  
passata su ante fisse  
Vetro trasparente grigio  
Sistema di scorrimento **Essenza**  
Maniglione MAN-T66 inox satinato

**Visioni**  
*Internal sliding double  
door on fixed leaves  
Gray transparent glass  
Sliding system Essenza  
MAN-T66 satin stainless steel pull handle*









**Visioni**

Porta doppia scorrevole opposta esterno muro  
Vetro reflex satinato grigio  
Sistema di scorrimento **Essenza**  
Maniglia VAS-Q

**Visioni**

Double sliding door opposite external wall  
Gray satin reflex glass  
Sliding system **Essenza**  
VAS-Q handle





# SCORREVOLE ESTERNO MURO **ESSENZA**

Finiture disponibili

**ANN**  
ALLUMINIO ANODIZZATO



## Caratteristiche tecniche

Portata massima 75 Kg/anta  
Larghezza minima foro muro 500 mm  
Lunghezza massima binario 6000 mm  
Ammortizzato (con limitazioni)

## Technical features

Maximum load 75 Kg/leaf  
Minimum wall opening width 500 mm  
Maximum track width 6000 mm  
Amortized (with limitations)

## Versioni disponibili Versions available

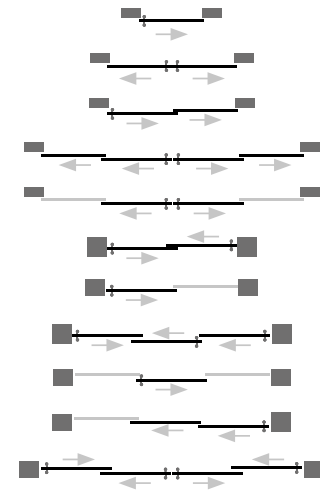

## Passaggio chiuso

Passage closed

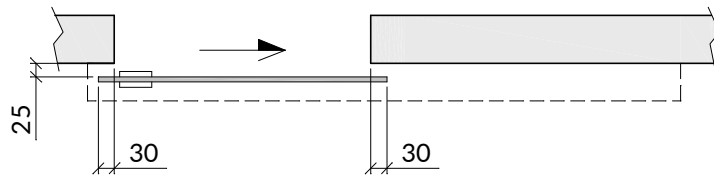

sormonto anta sul muro 30 mm per lato  
distanza anta dal muro 25 mm

door overlap on the wall 30 mm on each side  
door distance from the wall 25 mm

## Apertura totale

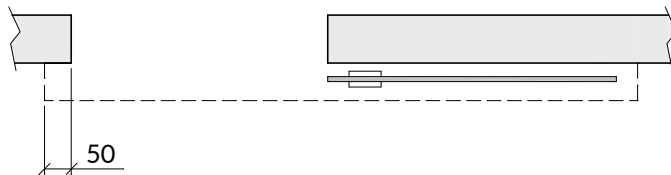

## Apertura parziale

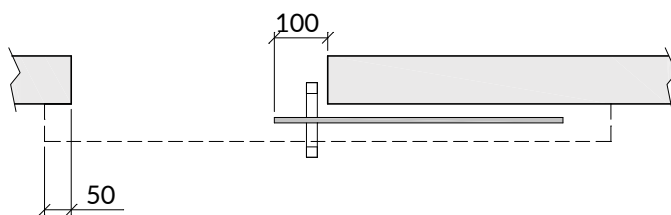

## Fissaggio binario a parete

Track fixing to the wall

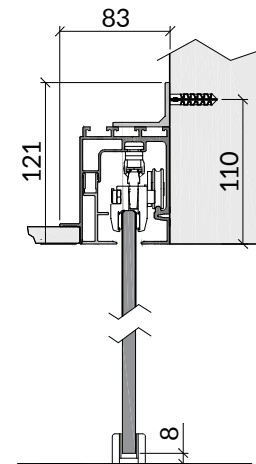

## Fissaggio binario a soffitto

Ceiling track fixing

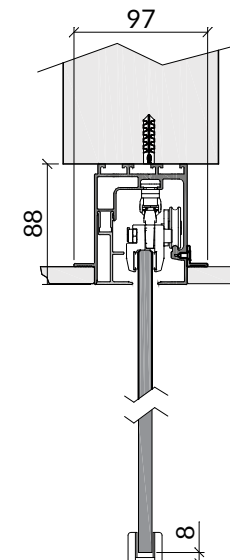

Per ulteriori informazioni tecniche consulta la scheda tecnica sul listino - For further technical information consult the technical data sheet on the price list



LUNA SOFT CLOSE:  
il design incontra la  
funzionalità Le porte  
in vetro scorrono  
senza sforzo su un  
sistema esterno  
leggero e dal design  
semplice, creando un  
ambiente raffinato

*LUNA SOFT CLOSE:  
the design meets  
functionality Glass  
doors slide effortlessly  
over a lightweight,  
simply designed exterior  
system, creating a  
refined environment*



# LUNA SOFT CLOSE

## VISIONI

SCORREVOLE ESTERNO MURO

### **Visioni**

Porta doppia scorrevole opposta  
Vetro Neutral extrachiaro  
Sistema di scorrimento **Luna soft close**  
Maniglia VAS-T

### **Visioni**

*Opposite double sliding door  
Neutral extra-clear glass  
Luna soft close slider system  
VAS-T handle*

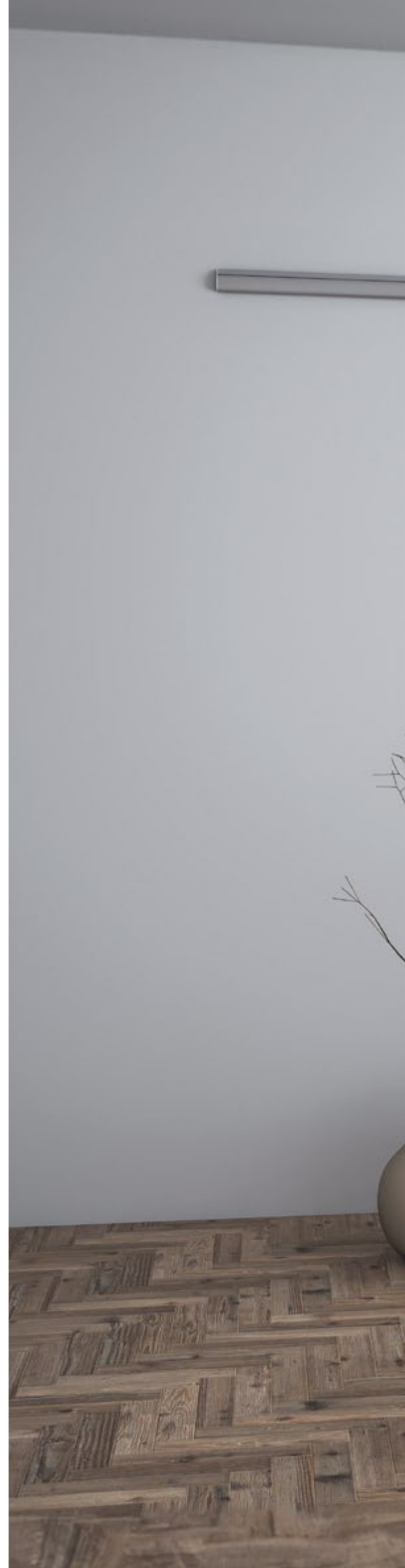







**Visioni**  
Porta scorrevole esterno muro  
Vetro satinato extrachiaro  
Sistema di scorrimento **Luna soft close**

**Visioni**  
*External wall sliding door*  
*Extra-clear satin glass*  
*Luna soft close slider system*





# SCORREVOLE ESTERNO MURO LUNA SOFT CLOSE

Finiture disponibili

IS  
INOX  
SATINATO



## Caratteristiche tecniche

Portata massima 70 Kg/anta  
Larghezza minima foro muro 400 mm  
Lunghezza massima binario 6000 mm  
Ammortizzato

## Technical features

Maximum load 70 Kg/leaf  
Minimum wall opening width 400 mm  
Maximum track width 6000 mm  
Amortized

## Versioni disponibili Versions available

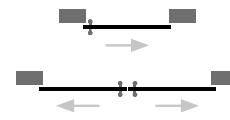

## Passaggio chiuso

Passage closed

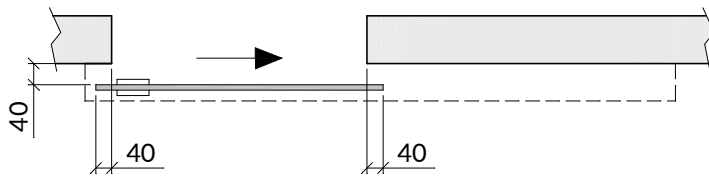

sormonto anta sul muro 40 mm per lato  
distanza anta dal muro 40 mm

door overlap on the wall 40 mm on each side  
door distance from the wall 40 mm

## Apertura totale

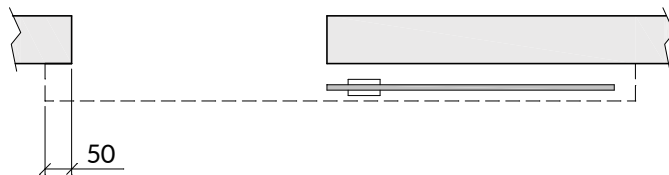

## Apertura parziale

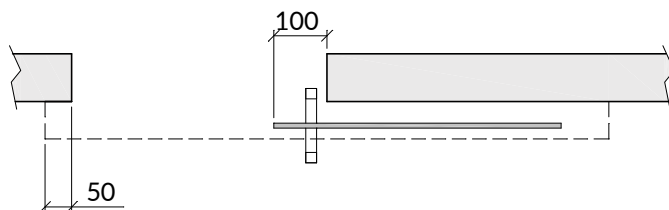

## Fissaggio binario a parete

Track fixing to the wall

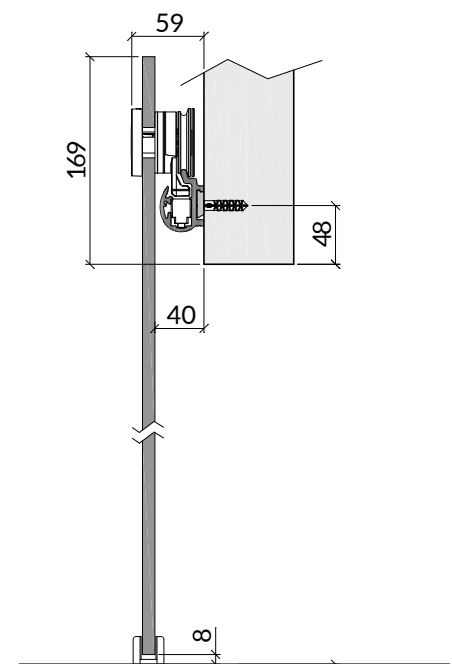

Per ulteriori informazioni tecniche consulta la scheda tecnica sul listino - For further technical information consult the technical data sheet on the price list







**PURO SOFT CLOSE:**  
la sintesi di stile e  
tecnologia.  
Le porte in vetro si  
muovono fluidamente  
grazie all'aggancio  
preciso sulla rotaia,  
garantendo un design  
puro e moderno

*PURO SOFT CLOSE:  
the synthesis of style  
and technology.  
The glass doors move  
fluidly thanks to the  
precise attachment to  
the track, guaranteeing a  
pure and modern design*

# PURO SOFT CLOSE VISIONI

SCORREVOLE ESTERNO MURO

## **Visioni**

Porta scorrevole esterno muro  
Vetro reflex trasparente grigio  
Sistema di scorrimento **Puro soft close**  
Maniglione MAN-T46

## **Visioni**

Sliding door external wall  
Gray transparent reflex glass  
Puro soft close flow system  
MAN-T46 pull handle







# SCORREVOLE ESTERNO MURO PURO SOFT CLOSE

Finiture disponibili

IS  
INOX  
SATINATO



## Caratteristiche tecniche

Portata massima 70 Kg/anta  
Larghezza minima foro muro 400 mm  
Lunghezza massima binario 6000 mm  
Ammortizzato

## Technical features

Maximum load 70 Kg/leaf  
Minimum wall opening width 400 mm  
Maximum track width 6000 mm  
Amortized

## Versioni disponibili Versions available

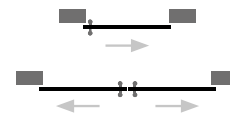

## Passaggio chiuso

Passage closed

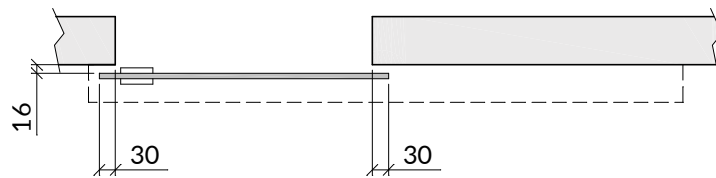

sormonto anta sul muro 30 mm per lato  
distanza anta dal muro 16 mm

door overlap on the wall 30 mm on each side  
door distance from the wall 16 mm

## Apertura totale

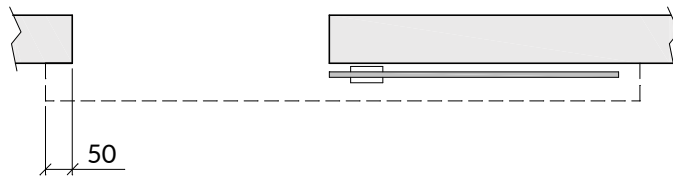

## Apertura parziale

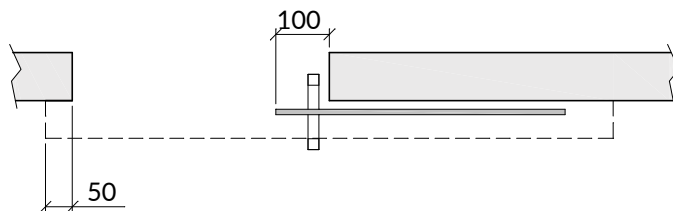

## Fissaggio binario a parete

Track fixing to the wall

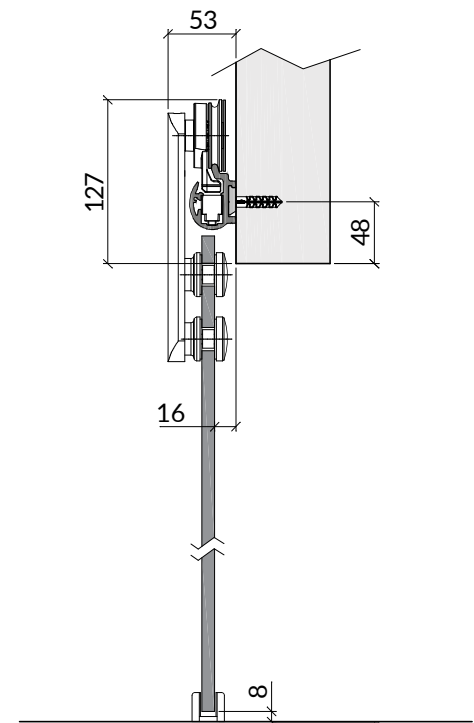

Per ulteriori informazioni tecniche consulta la scheda tecnica sul listino - For further technical information consult the technical data sheet on the price list



**EVASIONE:**  
la scelta ideale per  
chi fugge la banalità  
e per gli amanti della  
linearità e dell'estetica  
impeccabile: ambienti  
diversi si integrano in  
modo armonioso

**EVASIONE:**  
*the ideal choice for those  
who seek to escape banality  
and for lovers of linearity  
and impeccable aesthetics:  
diverse environments  
seamlessly integrate in a  
harmonious manner*

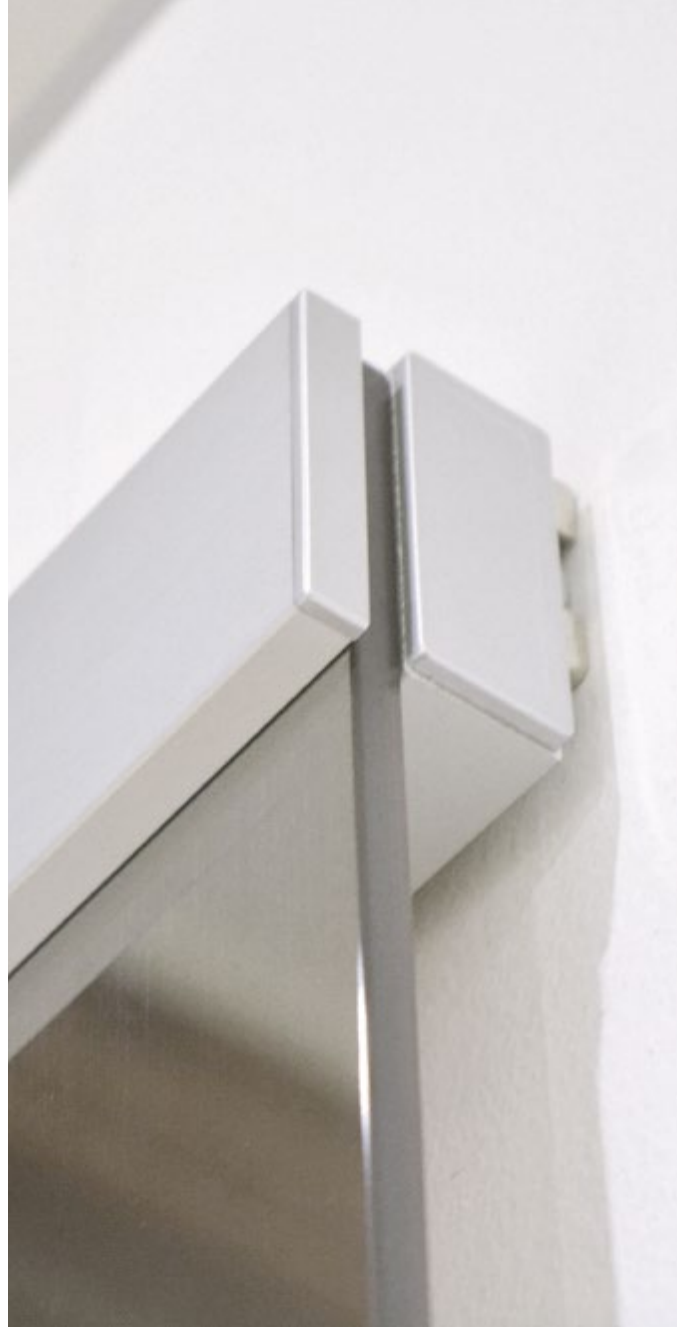

# EVASIONE VISIONI

SCORREVOLE ESTERNO MURO

**Visioni**

Porta scorrevole esterno muro  
Vetro reflex trasparente bronzo  
Sistema di scorrimento **Evasione**  
Maniglia MAN-Q20

**Visioni**

*External wall sliding door  
Bronze transparent reflex glass  
Scroll system Evasione  
MAN-Q20 handle*









# SCORREVOLE ESTERNO MURO **EVASIONE**

Finiture disponibili



## Caratteristiche tecniche

Portata massima 70 Kg/anta  
Larghezza minima foro muro 500 mm  
Lunghezza massima binario 1300 mm  
Ammortizzato

## Technical features

Maximum load 70 Kg/leaf  
Minimum wall opening width 500 mm  
Maximum track width 1300 mm  
Amortized

Versioni disponibili  
Versions available

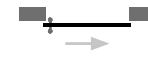

## Passaggio chiuso Passage closed

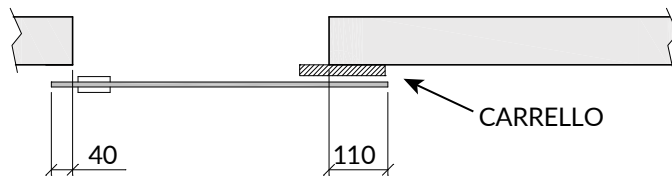

## Apertura massima

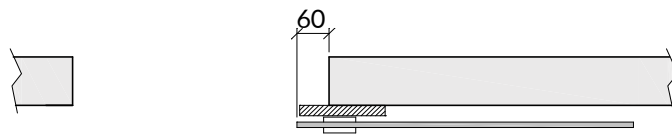

## Apertura parziale

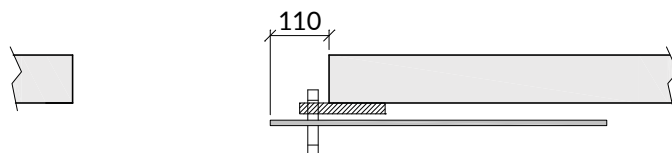

## Fissaggio binario a parete Track fixing to the wall

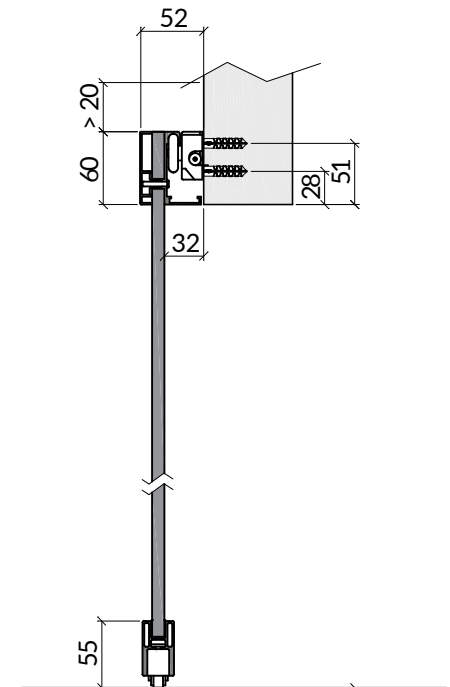

Per ulteriori informazioni tecniche consulta la scheda tecnica sul listino - For further technical information consult the technical data sheet on the price list







CUBO FLUID:  
grazie al sistema di  
scorrimento esterno  
muro si uniscono la  
solidità dell'ingegneria  
e la bellezza del  
design, per spazi  
eleganti e funzionali

*CUBO FLUID:  
thanks to the external  
wall sliding system,  
the solidity of the  
engineering and the  
beauty of the design  
combine for elegant  
and functional spaces*

# CUBO FLUID

## VISIONI

SCORREVOLE ESTERNO MURO

**Visioni**  
Porta scorrevole esterno muro  
Vetro trasparente grigio  
Sistema di scorrimento **Cubo Fluid**  
Maniglione MAN-Q46

**Visioni**  
*External wall sliding door  
Gray transparent glass  
Cubo Fluid sliding system  
MAN-Q46 pull handle*







# SCORREVOLE ESTERNO MURO CUBO FLUID

Finiture disponibili

ANN  
ALLUMINIO  
ANODIZZATO

VN  
VERNICIATO  
NERO



## Caratteristiche tecniche

Portata massima 75 Kg/anta  
Larghezza minima foro muro 500 mm  
Lunghezza massima binario 6000 mm  
Ammortizzato

## Technical features

Maximum load 75 Kg/leaf  
Minimum wall opening width 500 mm  
Maximum track width 6000 mm  
Amortized

## Versioni disponibili Versions available

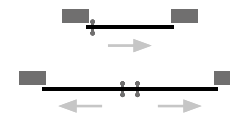

## Passaggio chiuso Passage closed

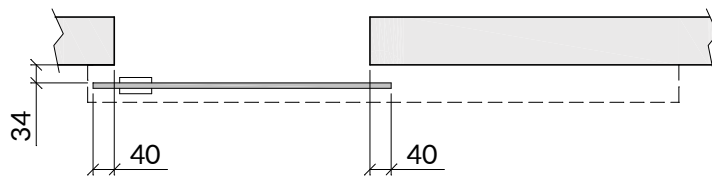

sormonto anta sul muro 40 mm per lato  
distanza anta dal muro 34 mm

door overlap on the wall 40 mm on each side  
door distance from the wall 34 mm

## Apertura totale

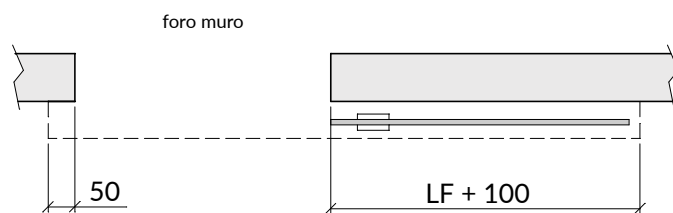

## Apertura parziale

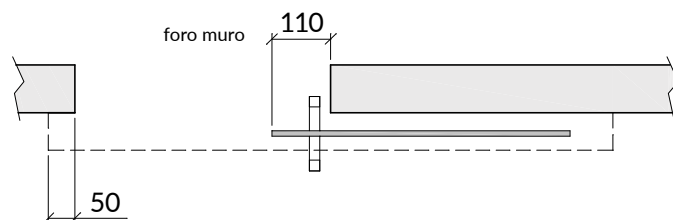

## Fissaggio binario a parete Track fixing to the wall

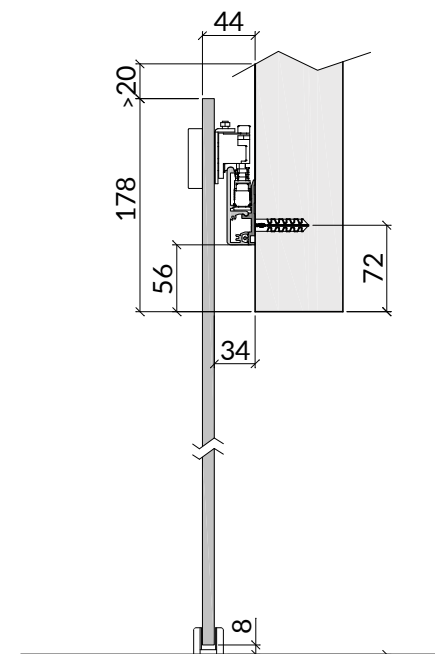



MINERVA:  
l'eleganza e la  
funzionalità unite in  
una porta scorrevole  
interna, per un design  
senza compromessi  
e un'esperienza di  
apertura fluida

MINERVA:  
*elegance and functionality  
combined in an internal  
sliding door, for an  
uncompromising design  
and a fluid opening  
experience*



# MINERVA VISIONI

SCORREVOLE INTERNO MURO  
SENZA TELAIO

**Visioni**

Porta scorrevole interno muro  
Vetro trasparente dark  
Maniglia VAS-TS

**Visioni**

Internal wall sliding door  
Transparent dark glass  
VAS-TS handle











PARIDE:  
l'equilibrio perfetto tra  
design e robustezza  
La nostra porta  
scorrevole interna  
con telaio offre stile  
e affidabilità senza  
paragoni

*PARIDE:  
the perfect balance  
between design and  
robustness Our internal  
sliding door with frame  
offers unmatched style  
and reliability*

# PARIDE VISIONI

SCORREVOLE INTERNO MURO  
CON TELAIO

**Visioni**  
Porta scorrevole interno muro  
Vetro Hays grigio

**Visioni**  
*Internal sliding door  
Hays gray glass*





# SCORREVOLE INTERNO MURO SENZA TELAIO **MINERVA**

Finiture disponibili

ANN

ALLUMINIO ANODIZZATO

VBI

VERNICIATO BIANCO

VN

VERNICIATO NERO

VS

VERNICIATO COL SPECCHIO



## Caratteristiche tecniche

Portata massima 120 Kg/anta

Larghezza minima di passaggio 400 mm

## Technical features

Maximum load 120 Kg/leaf

Minimum passage width 400 mm

## Versioni disponibili

Versions available

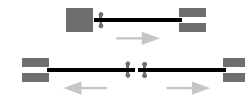

## Passaggio chiuso

Passage closed

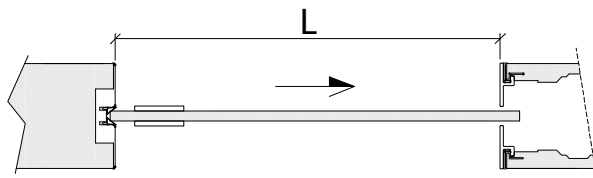

## Apertura totale

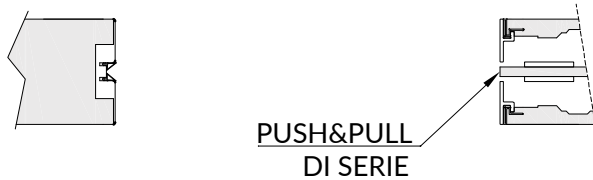

## Apertura parziale



## Sezione verticale

Vertical section

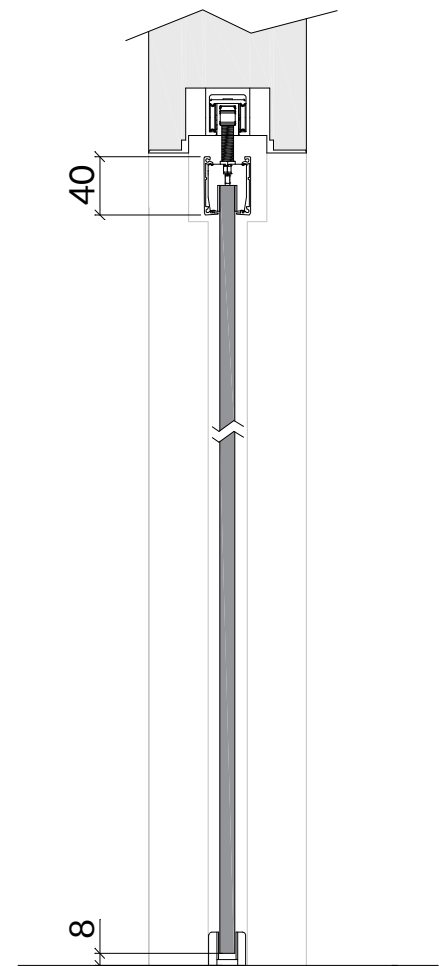

Per ulteriori informazioni tecniche consulta la scheda tecnica sul listino - For further technical information consult the technical data sheet on the price list

# SCORREVOLE INTERNO MURO CON TELAIO **PARIDE**



## Caratteristiche tecniche

Portata massima 120 Kg/anta

Larghezza minima di passaggio 400 mm

## Technical features

Maximum load 120 Kg/leaf

Minimum passage width 400 mm

## Versioni disponibili

*Versions available*

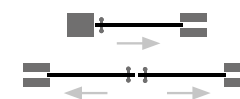

## Passaggio chiuso

*Passage closed*

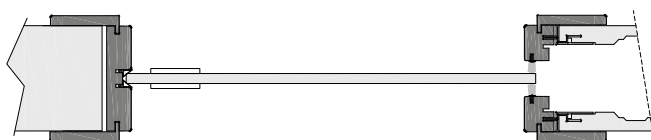

## Apertura totale

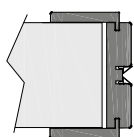

PUSH&PULL  
DI SERIE

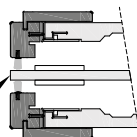

## Apertura parziale

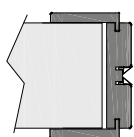

STOP  
DI SERIE

80

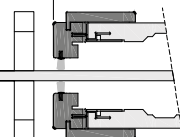

## Sezione verticale

*Vertical section*

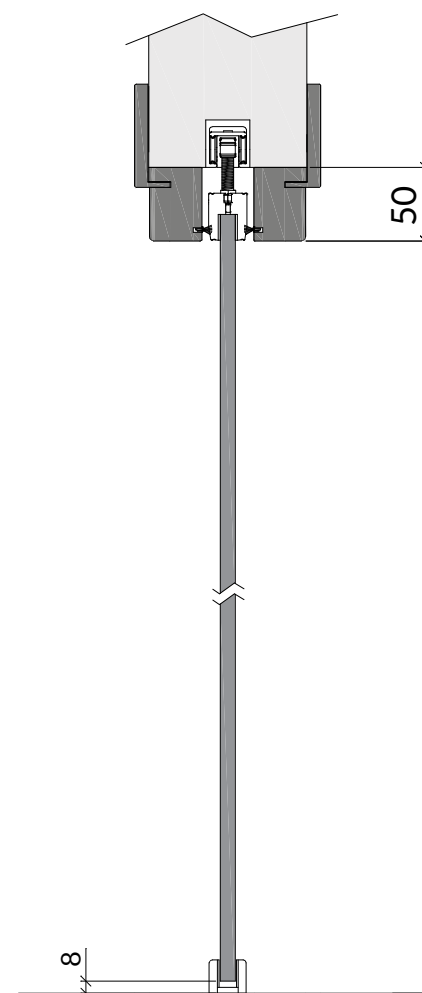





EVO

EVO1

ARYS:  
la porta in vetro va  
e viene che coniuga  
trasparenza e praticità  
Soluzione versatile per  
un passaggio alternato  
in ogni ambiente

ARYS:  
*the back and forth glass  
door that combines  
transparency and  
practicality Versatile  
solution for alternating  
passage in any  
environment*



# ARYS VISIONI

P O R T A   A   V E N T O L A

**Visioni**

Porta a ventola con cerniera EVO  
Vetro satinato grigio  
Maniglione MAN-Q30 inox satinato

**Visioni**

*Fan door with EVO zip  
Gray satin glass  
MAN-Q30 satin stainless steel pull handle*











**NEMESI:**  
una porta  
in vetro che sfida le  
convenzioni conferisce  
eleganza audace e  
apertura inusuale  
a ogni ambiente

**NEMESI:**  
*a pivot glass door that  
challenges conventions it  
gives bold elegance and  
unusual openness to  
any environment*

# NEMESI VISIONI

PORTA A BILICO PIVOT

**Visioni**

Porta a pivot  
Vetro trasparente grigio  
Sistema di apertura bilico pavimento soffitto  
Maniglione MAN-Q30 inox satinato

**Visioni**

*Pivot door  
Gray transparent glass  
Floor-to-ceiling pivot opening system  
MAN-Q30 satin stainless steel pull handle*





# PORTA A VENTOLA **ARYS**

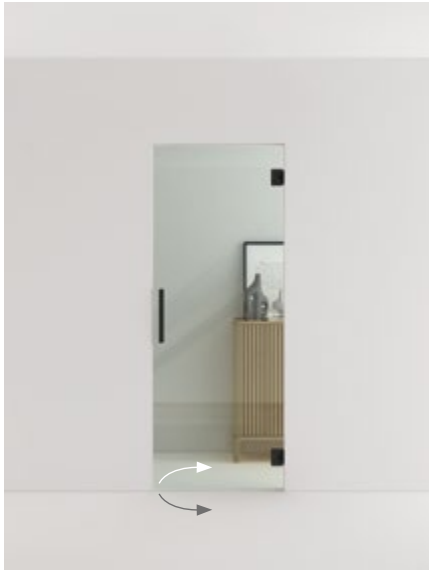

**Arys con cerniere EVO a scatto**

**Caratteristiche tecniche**

Portata massima 65 Kg/anta  
 Tipologia chiusura: Libera  
 Apertura massima +90°/-90°  
 Larghezza massima di passaggio 900 mm

**Technical features**

Maximum load 65 Kg/leaf  
 Closure type: Free  
 Maximum opening +90°/-90°  
 Maximum passage width 900 mm

Finiture disponibili

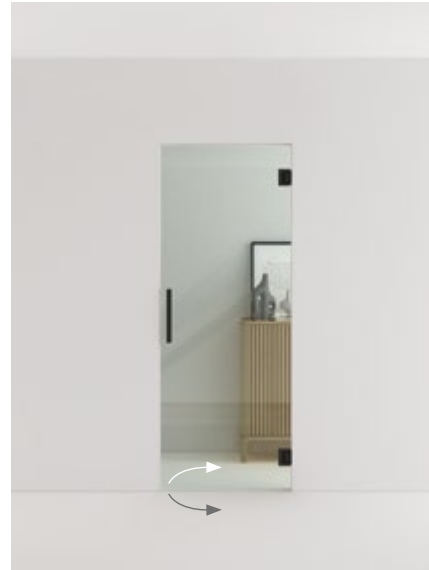

**Arys con cerniere EVO1 oleodinamiche**

**Caratteristiche tecniche**

Portata massima 100 Kg/anta  
 Tipologia chiusura: oleodinamiche  
 Apertura massima +90°/-90°  
 Larghezza massima di passaggio 1000 mm

**Technical features**

Maximum load 100 Kg/leaf  
 Closure type: Free  
 Maximum opening +90°/-90°  
 Maximum passage width 900 mm

Finiture disponibili



Per ulteriori informazioni tecniche consulta la scheda tecnica sul listino - For further technical information consult the technical data sheet on the price list

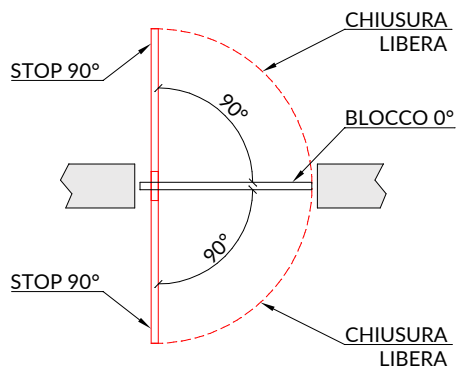

**Versioni disponibili**

Versions available

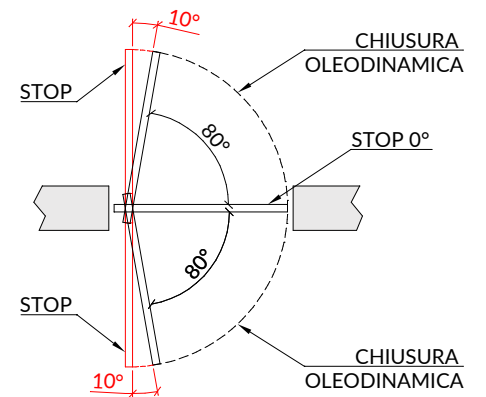
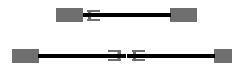

**Arys muro a vista**

**Porta a ventola con muro a vista**

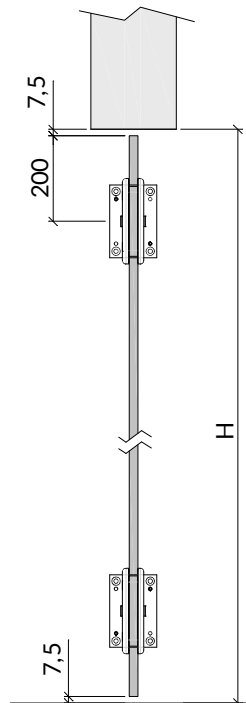
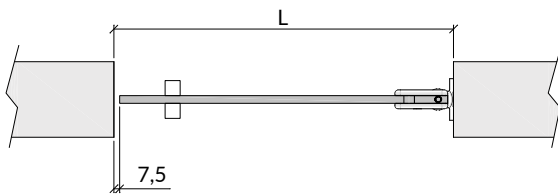

# PORTA A BILICO PIVOT NEMESI

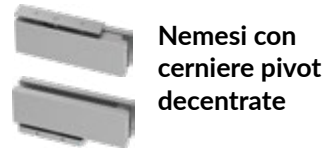

Nemesi con  
cerniere pivot  
decentrate

### Caratteristiche tecniche

Portata massima 100 Kg/anta  
 Tipologia chiusura: Oleodinamica  
 Apertura massima +90°/-90°  
 Larghezza massima di passaggio 1000 mm  
 Larghezza massima vetro 1600 mm

### Technical features

Maximum load 100 Kg/leaf  
 Closure type: Oleodinamic  
 Maximum opening +90°/-90°  
 Maximum passage width 1000 mm  
 Maximum glass width 1600 mm

Finiture  
disponibili



Nemesi con  
cerniere pivot  
a filo anta

### Caratteristiche tecniche

Portata massima 100 Kg/anta  
 Tipologia chiusura: Oleodinamica  
 Apertura massima +90°/-90°  
 Larghezza massima di passaggio 1000 mm  
 Larghezza massima vetro 1000 mm

### Technical features

Maximum load 100 Kg/leaf  
 Closure type: Oleodinamic  
 Maximum opening +90°/-90°  
 Maximum passage width 1000 mm  
 Maximum glass width 1000 mm

Finiture  
disponibili

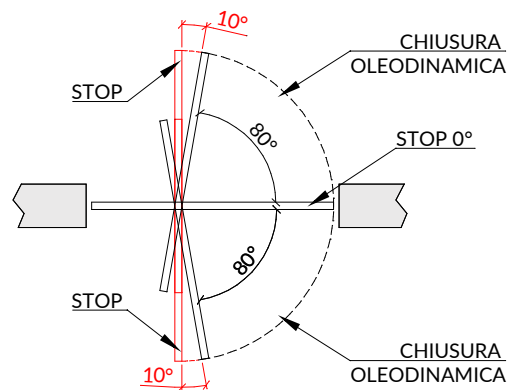

### Versioni disponibili

Versions available

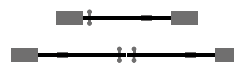

### Nemesi muro a vista

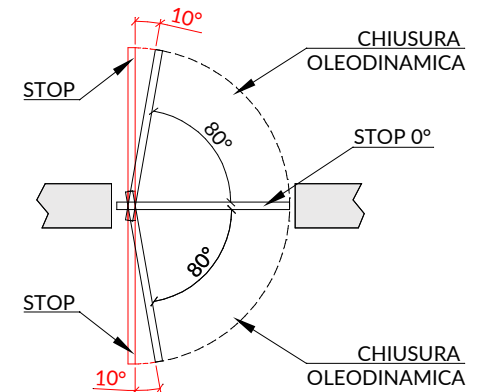
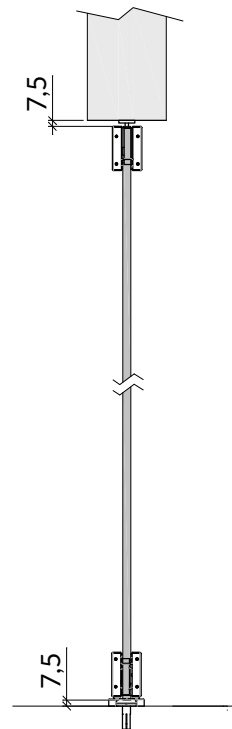

### Porta a bilico con muro a vista

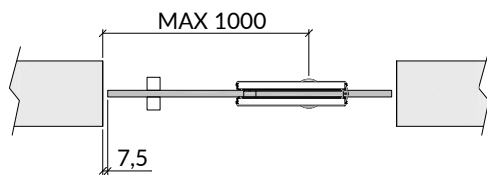

### Porta a bilico con muro a vista

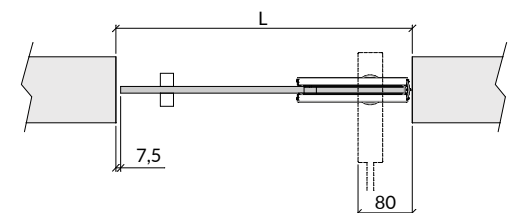





**STYLE:**  
la porta a battente che  
definisce l'eleganza  
Unisce design  
contemporaneo, qualità  
e funzionalità per  
un'entrata all'insegna  
della modernità

**STYLE:**  
*the swing door that  
defines elegance It  
combines contemporary  
design, quality and  
functionality for a  
modern entrance*



# STYLE VISIONI

P O R T A   A   B A T T E N T E

**Visioni**

Porta a battente Style  
Vetro satinato grigio  
Maniglia M

**Visioni**

*Style swing door  
Gray satin glass  
M handle*











**ATHENA:**  
la porta in vetro a battente  
con cerniere che offre  
eleganza e resistenza, per  
un ingresso raffinato ed  
esclusivo

**ATHENA:**  
*the swing glass door with  
hinges that offers elegance  
and resistance, for a refined  
and exclusive entrance*

# ATHENA

## VISIONI

PORTA A BATTENTE

**Visioni**  
Porta a battente Athena  
Vetro trasparente extrachiario  
Maniglia ATM

**Visioni**  
*Swing door Athena  
Extra-clear transparent glass  
ATM handle*





# PORTA A BATTENTE **STYLE**

**Finiture disponibili**

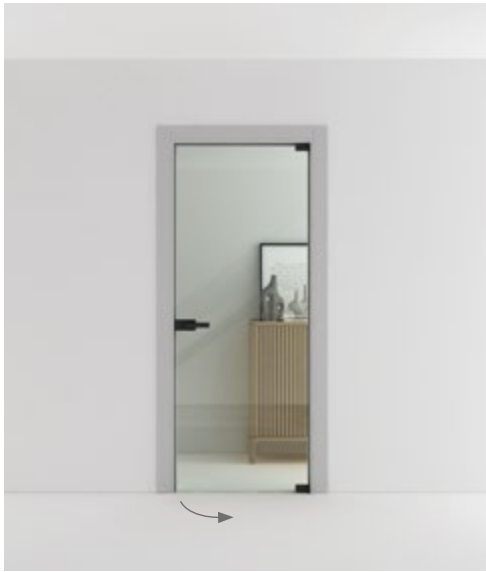

**Caratteristiche tecniche**

Portata massima 60 Kg/anta  
 Altezza massima foro muro 2700 mm  
 Larghezza massima 900 mm

**Technical features**

Maximum load 60 Kg/leaf  
 Maximum wall opening height 2700 mm  
 Maximum width 900 mm

**Versioni disponibili**  
*Versions available*

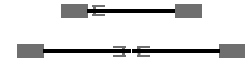

**Telai disponibili vedi pag 70**  
*Available frames see page 70*

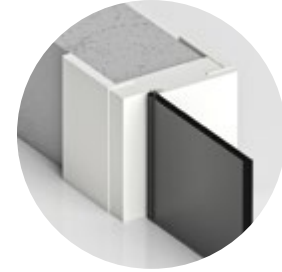

Per ulteriori informazioni tecniche consulta la scheda tecnica sul listino - For further technical information consult the technical data sheet on the price list

**Porta a battente Style con telaio in legno**  
*Passage closed*

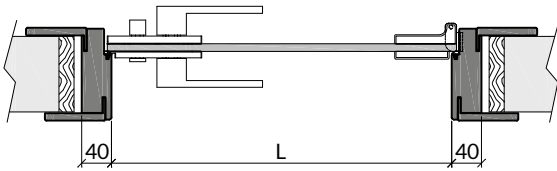

**Style con telaio in legno**

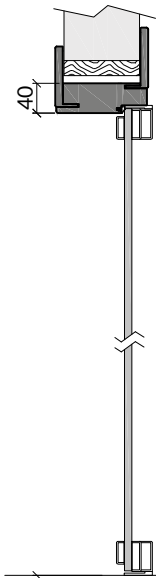

**Style con telaio raso muro**

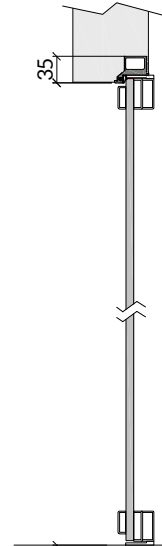

**Style con telaio in alluminio**

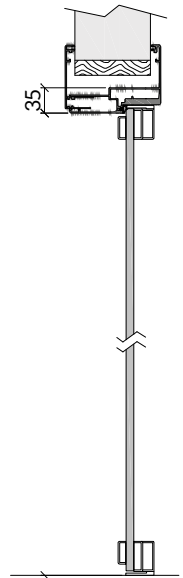

**Porta a battente Style con telaio raso muro**

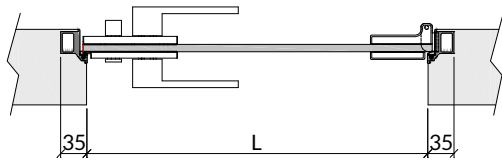

**Porta a battente Style con telaio in alluminio**

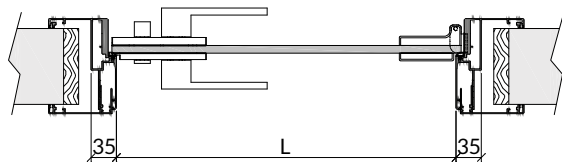

# PORTA A BATTENTE **ATHENA**

Finiture disponibili

ANN

ALLUMINIO  
ANODIZZATO

GBK

ALLUMINIO  
ANODIZ. NERO

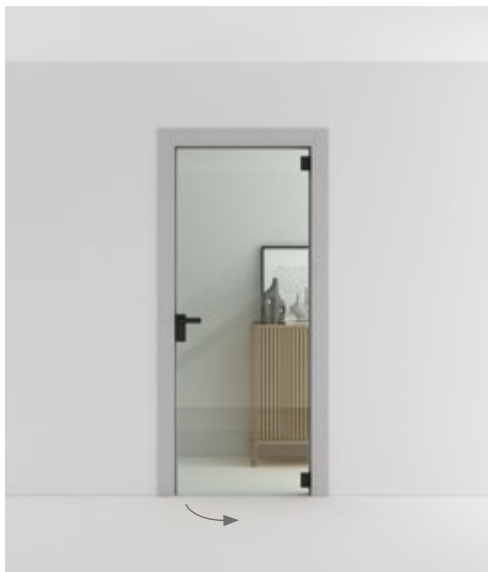

## Caratteristiche tecniche

Portata massima 60 Kg/anta  
Altezza massima foro muro 2700 mm  
Larghezza massima 900 mm

## Technical features

Maximum load 60 Kg/leaf  
Maximum wall opening height 2700 mm  
Maximum width 900 mm

Versioni disponibili  
Versions available

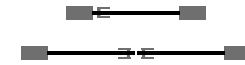

Telai disponibili vedi pag 70  
Available frames see page 70

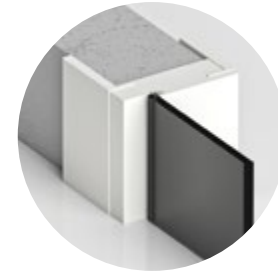

Porta a battente Athena con telaio in legno  
Passage closed

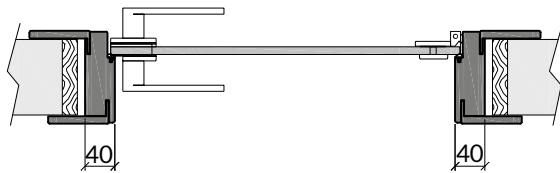

Athena  
con telaio  
in legno

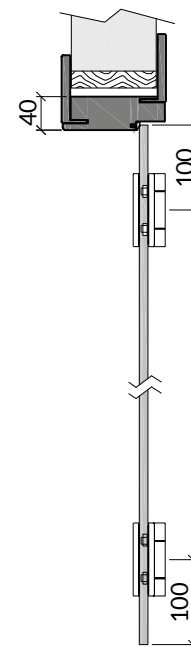

Athena  
con telaio  
raso muro

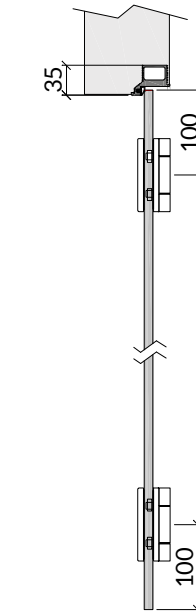

Athena  
con telaio  
in alluminio

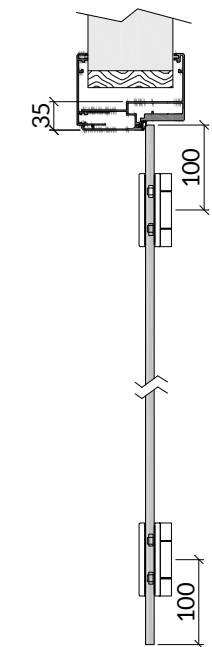

Porta a battente Athena con telaio raso muro

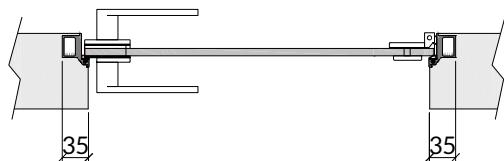

Porta a battente Athena con telaio in alluminio

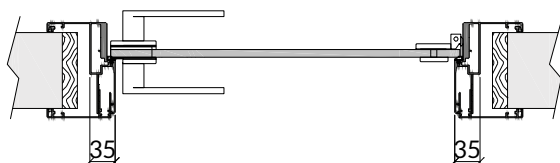



# TELAI **BATTENTI** per porte *Visioni*

 **Telaio TN**  
in legno/wood

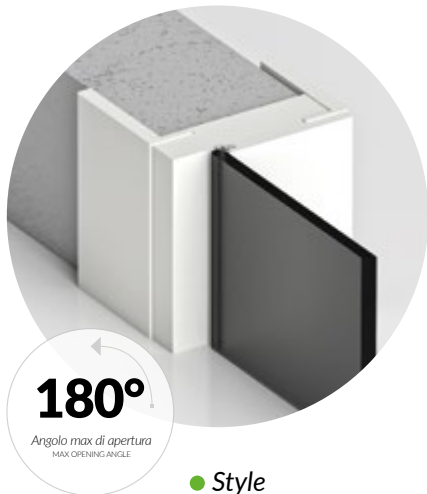

 **Telaio TS**  
in legno/wood



 **Telaio TSP**  
in legno/wood

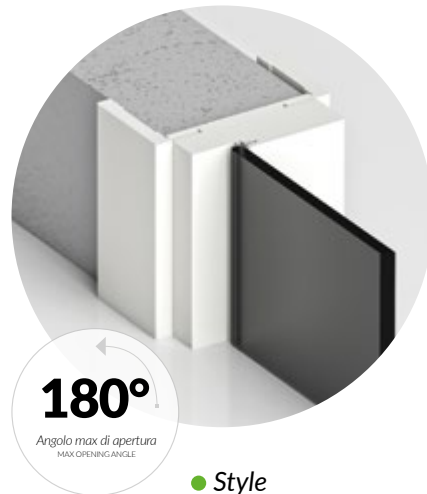

 **Telaio TX**  
in legno/wood



 **Telaio TXS**  
in legno/wood



 **Telaio TA**  
in alluminio/aluminium



 **Telaio RSN**  
rasomuro/close to the wall

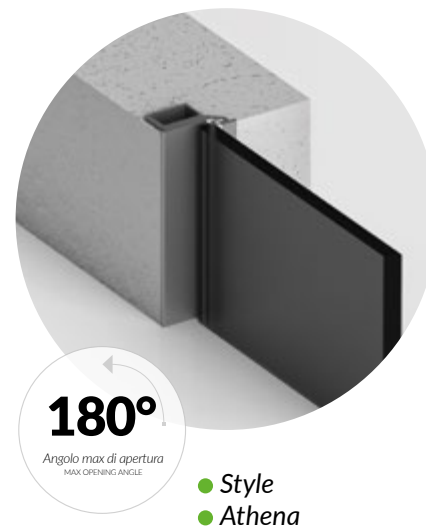

# Tipologie di **APERTURA** per porte *Visioni*



p.24

Scorrevole esterno muro **Maestro**



p.30

Scorrevole esterno muro **Essenza**



p.36

Scorrevole esterno muro **Luna soft close**



p.40

Scorrevole esterno muro **Puro soft close**



p.44

Scorrevole esterno muro **Evasione**



p.48

Scorrevole esterno muro **Cubo Fluid**



p.52

Scorrevole interno muro **Minerva**



p.54

Scorrevole interno muro **Paride**

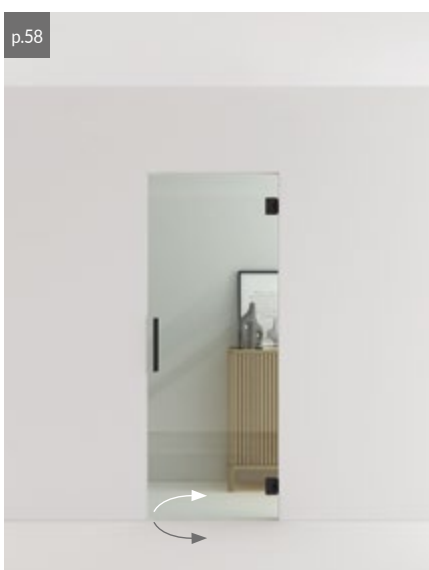

p.58

Porta a ventola **Arys**

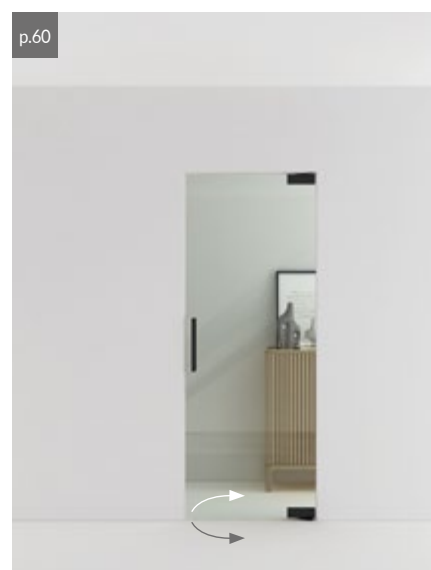

p.60

Porta bilico pivot **Nemesi**



p.64

Porta a battente **Style**

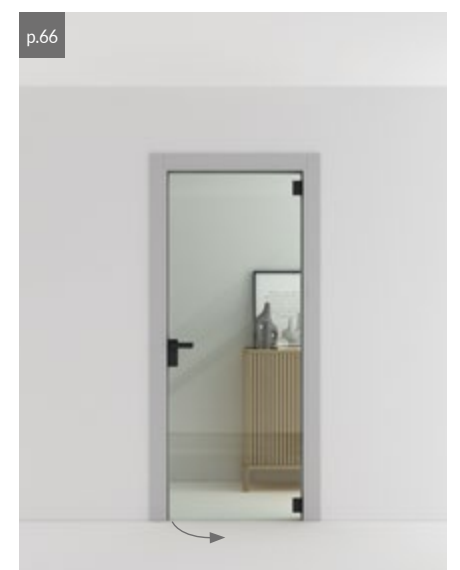

p.66

Porta a battente **Athena**



VELO:  
l'eleganza in  
movimento scorrevole  
esterno muro, questa  
porta in vetro con  
profili unisce design  
moderno e funzionalità  
senza compromessi

VELO:  
*elegance in movement  
Sliding external wall,  
this glass door with  
profiles combines  
modern design and  
uncompromising  
functionality*



# VELO

## VISIONI PROFILE

SCORREVOLE ESTERNO MURO

**Visioni Profile**

Porta scorrevole esterno muro con profili grafite  
Vetro trasparente grigio  
Sistema di scorrimento **VELO**  
Maniglione MAN-PR28

**Visioni Profile**

*External wall Sliding door with graphite profiles  
Gray transparent glass  
Velo sliding system  
MAN-PR28 pull handle*









**Visioni Profile**  
Porte scorrevoli opposte  
interno passata  
Vetro trasparente bronzo  
con profili sohara  
Sistema di scorrimento  
**Velo** a soffitto  
Maniglione MAN-PR28

**Visioni Profile**  
*Opposite sliding doors  
internal pass  
Bronze transparent glass  
with sohara profiles  
Velo ceiling sliding system  
MAN-PR28 pull handle*





**Visioni Profile**  
Porta doppia scorrevole  
in luce su anta fissa  
Vetro trasparente extrachiario  
con profili bianchi  
Sistema di scorrimento  
**Velo** a soffitto  
Maniglione MAN-PR28

**Visioni Profile**  
Opening double sliding  
door on fixed leaf  
Extra clear glass  
with white profiles  
Velo ceiling sliding system  
MAN-PR28 pull handle



# SCORREVOLE ESTERNO MURO VELO

## Finiture disponibili



### Caratteristiche tecniche

Portata massima 100 Kg/anta  
 Altezza massima foro muro 3000 mm  
 Larghezza minima anta 400 mm  
 Larghezza massima binario 6000 mm  
 Ammortizzato (con limitazioni)

### Technical features

Maximum load 100 Kg/leaf  
 Maximum wall opening height 3000 mm  
 Minimum door width 400 mm  
 Maximum track width 6000 mm  
 Amortized (with limitations)

## Versioni disponibili Versions available

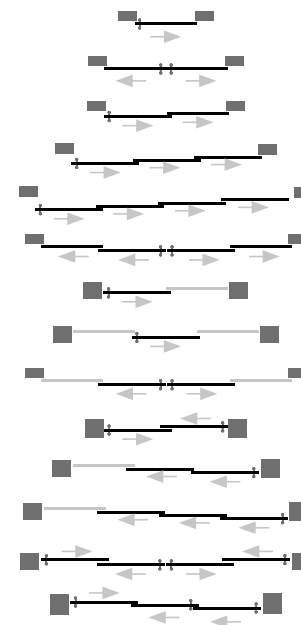

Per ulteriori informazioni tecniche consulta la scheda tecnica sul listino - For further technical information consult the technical data sheet on the price list

### Passaggio chiuso Passage closed

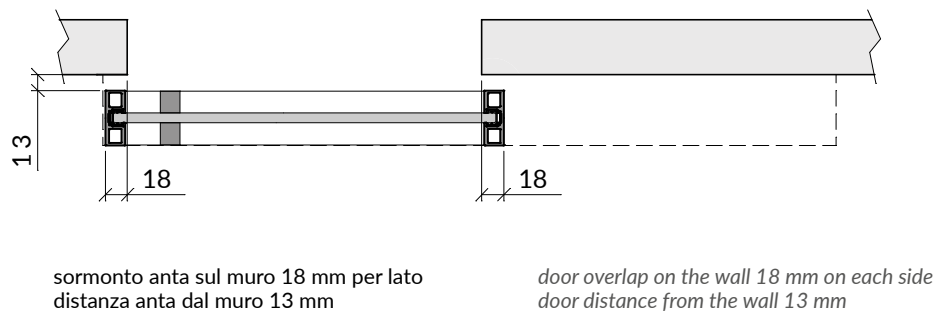

### Apertura massima

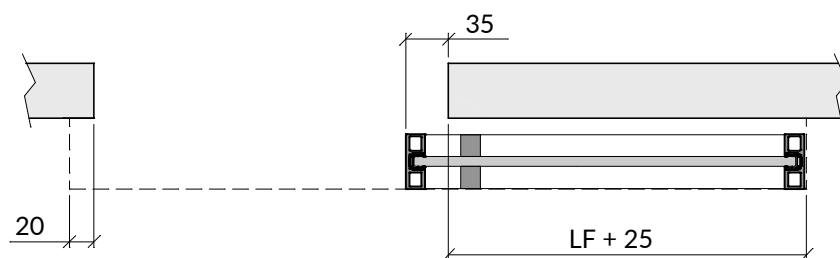

### Fissaggio binario a soffitto Ceiling track fixing

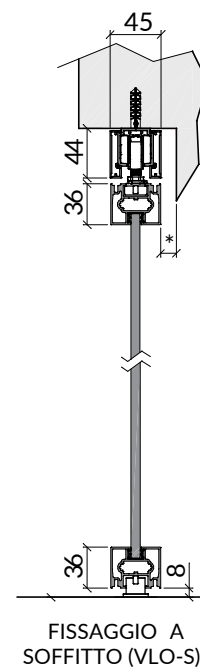

### Fissaggio binario a parete Track fixing to the wall

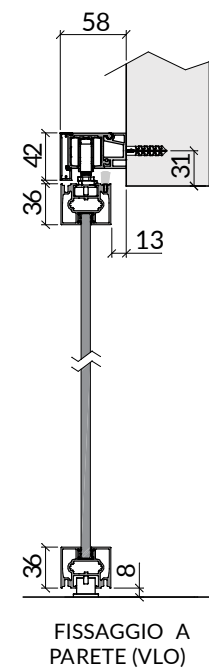

### Profili anta

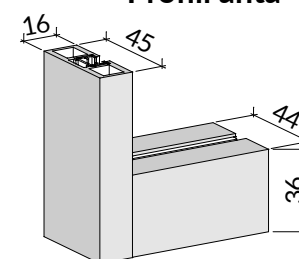







NEXUS  
crea uno spazio  
senza interruzioni:  
porte in vetro che  
scorrono in modo fluido  
a filo con il soffitto

*NEXUS  
create a seamless  
space: glass doors  
which slide fluidly  
flush with the ceiling*

# NEXUS VISIONI PROFILE

SCORREVOLE ESTERNO MURO

Visioni Profile  
Porta doppia scorrevole opposta esterno muro  
Vetro trasparente extrachiario con profilo bianco  
Sistema di scorrimento **Nexus**  
Maniglia MAN-PR28

**Visioni Profile**  
*Double sliding door opposite external wall  
Extra clear glass with white profile  
Nexus scroll system  
MAN-PR28 handle*







# SCORREVOLE ESTERNO MURO NEXUS

## Finiture disponibili



### Caratteristiche tecniche

Portata massima 100 Kg/anta  
 Altezza massima foro muro 3000 mm  
 Larghezza minima anta 400 mm  
 lunghezza massima binario 6000 mm  
 Ammortizzato

### Technical features

Maximum load 100 Kg/leaf  
 Maximum wall opening height 3000 mm  
 Minimum door width 400 mm  
 Maximum track length 6000 mm  
 Amortized

## Versioni disponibili Versions available

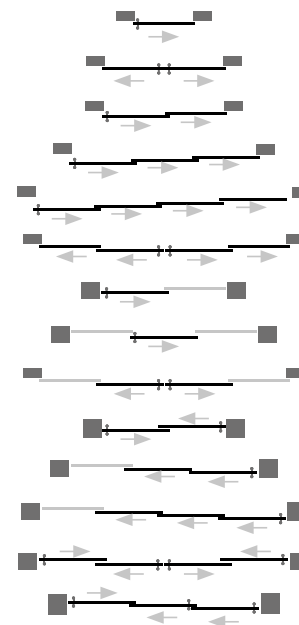

### Passaggio chiuso Passage closed

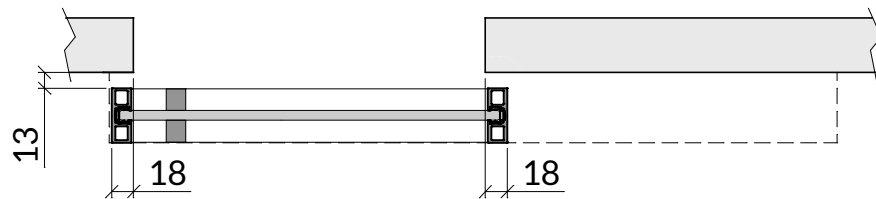

sormonto anta sul muro 18 mm per lato  
 distanza anta dal muro 13 mm

door overlap on the wall 18 mm for side  
 door distance from the wall 13 mm

### Apertura massima

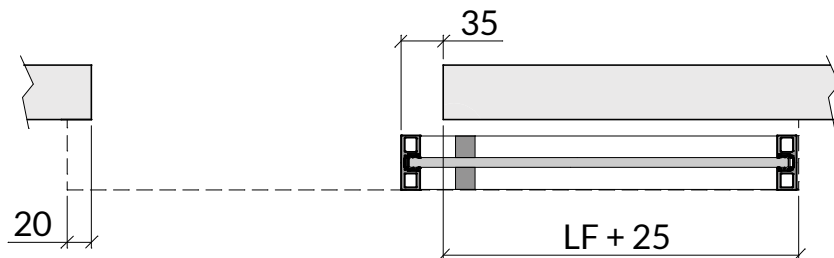

calcolo larghezza binario  
 larghezza foro muro x 2 + 25 mm

track width calculation  
 wall opening width x 2 + 25 mm

### Fissaggio binario a soffitto Ceiling track fixing

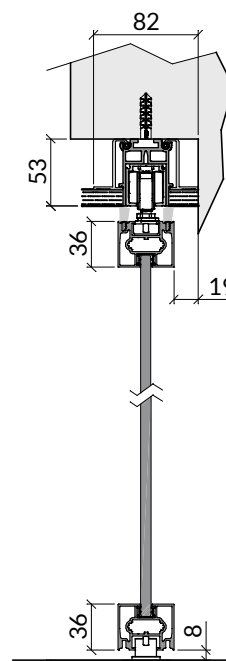

### Fissaggio binario a parete Track fixing to the wall

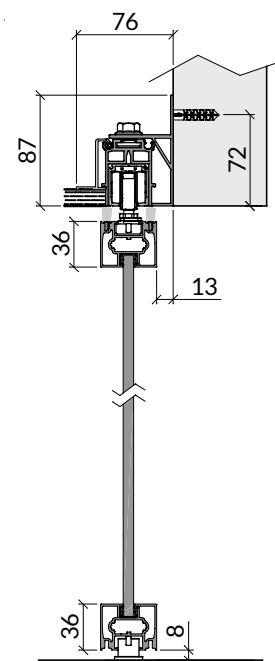

### Profili anta

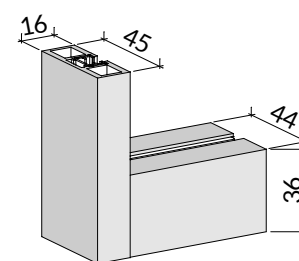

Per ulteriori informazioni tecniche consulta la scheda tecnica sul listino - For further technical information consult the technical data sheet on the price list



MASCA  
trasforma gli ambienti:  
le porte scorrono come  
per magia, rendendo  
ogni movimento di  
apertura e chiusura  
un'esperienza unica

MASCA  
*transform environments:  
doors slide as if by  
magic, making every  
opening and closing  
movement a unique  
experience*



# MASCA VISIONI PROFILE

SCORREVOLE ESTERNO MURO

**Visioni Profile**

Porta scorrevole esterno muro  
Vetro trasparente extrachiario con profili gold  
Sistema di scorrimento **Masca**  
Maniglione MAN-PR28

**Visioni Profile**

*External wall sliding door  
Extra-clear transparent glass with gold profiles  
Masca sliding system  
MAN-PR28 pull handle*









# SCORREVOLE ESTERNO MURO MASCA

Finiture disponibili



## Caratteristiche tecniche

Portata massima 70 Kg/anta  
 Altezza massima foro muro 2800 mm  
 Larghezza minima anta 700 mm  
 Ammortizzato

## Technical features

Maximum load 70 Kg/leaf  
 Maximum wall opening height 2800 mm  
 Minimum door width 700 mm  
 Amortized

## Versioni disponibili

Versions available



## Passaggio chiuso con apertura parziale

Passage closed

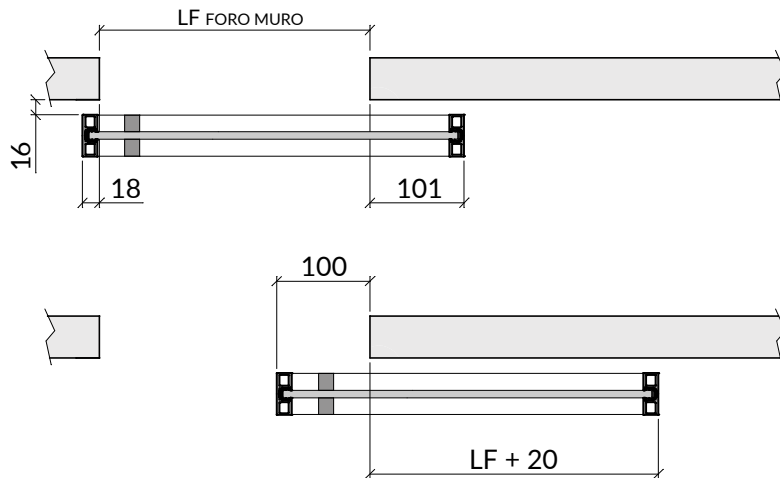

sormonto anta sul muro 18 mm  
 sul lato maniglia  
 sormonto anta sul muro 101 mm  
 sul lato opposto maniglia  
 distanza anta dal muro 16 mm

door overlap on the wall 18 mm  
 on the handle side  
 door overlap on the wall 101 mm  
 on the side opposite the handle  
 door distance from the wall 16 mm

## Fissaggio binario a parete

Track fixing to the wall

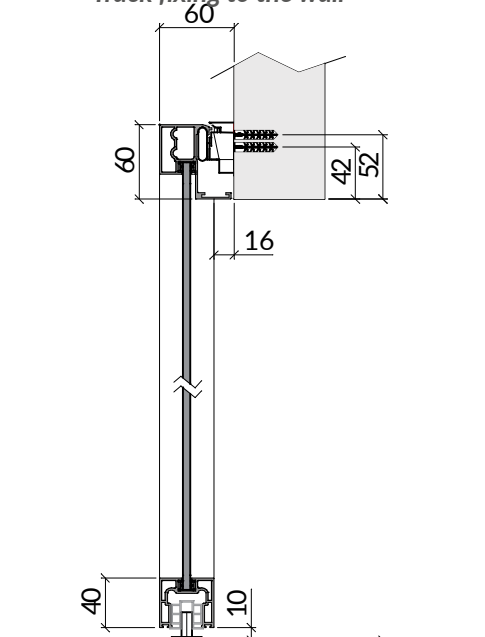

## Passaggio chiuso con apertura totale

Passage closed

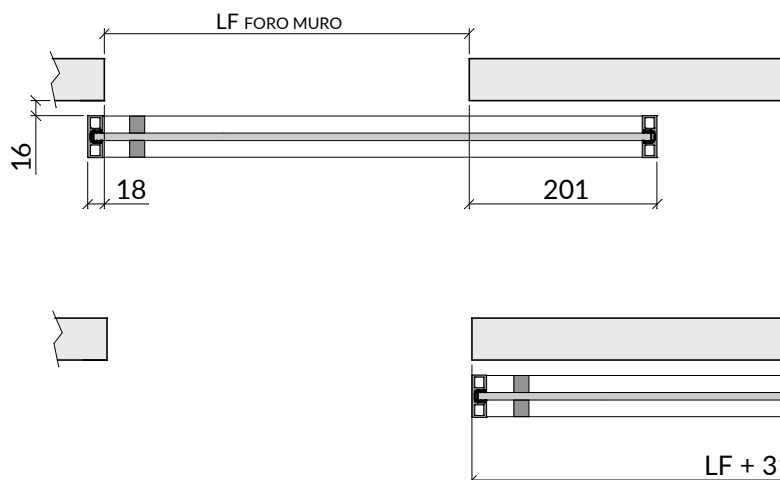

sormonto anta sul muro 18 mm  
 sul lato maniglia  
 sormonto anta sul muro 201 mm  
 sul lato opposto maniglia  
 distanza anta dal muro 16 mm

door overlap on the wall 18 mm  
 on the handle side  
 door overlap on the wall 201 mm  
 on the side opposite the handle  
 door distance from the wall 16 mm

## Profili anta

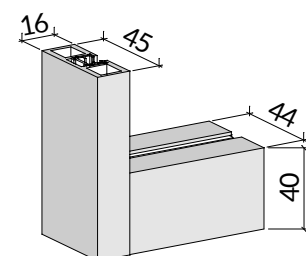

Per ulteriori informazioni tecniche consulta la scheda tecnica sul listino - For further technical information consult the technical data sheet on the price list







VENERE:  
l'armonia del design  
Una porta in vetro  
con profili, scorrevole  
interno muro, con  
telaio, che coniuga  
estetica e funzionalità  
per un ambiente  
raffinato

VENERE:  
*the harmony of design A  
glass door with profiles,  
sliding inside the wall,  
with frame, which  
combines aesthetics and  
functionality for a refined  
environment*

# VENERE VISIONI PROFILE

SCORREVOLE INTERNO MURO CON TELAIO

**Visioni Profile**

Porta scorrevole interno muro  
Vetro trasparente grigio con profili alluminio  
Maniglione MAN-PR28 alluminio  
Telaio TX finitura grigio matt

**Visioni Profile**

*Internal wall sliding door  
Gray glass with aluminum profiles  
MAN-PR28 pull handle aluminium  
Matt gray finish TX frame*





DYANA:  
l'essenza dell'eleganza  
minimalista Una porta  
in vetro con profili,  
scorrevole interno  
muro, senza telaio,  
che conferisce stile e  
modernità all'ambiente

*DYANA:  
the essence of minimalist  
elegance A glass door  
with profiles, sliding  
inside the wall, without  
frame, which gives style  
and modernity to the  
environment*

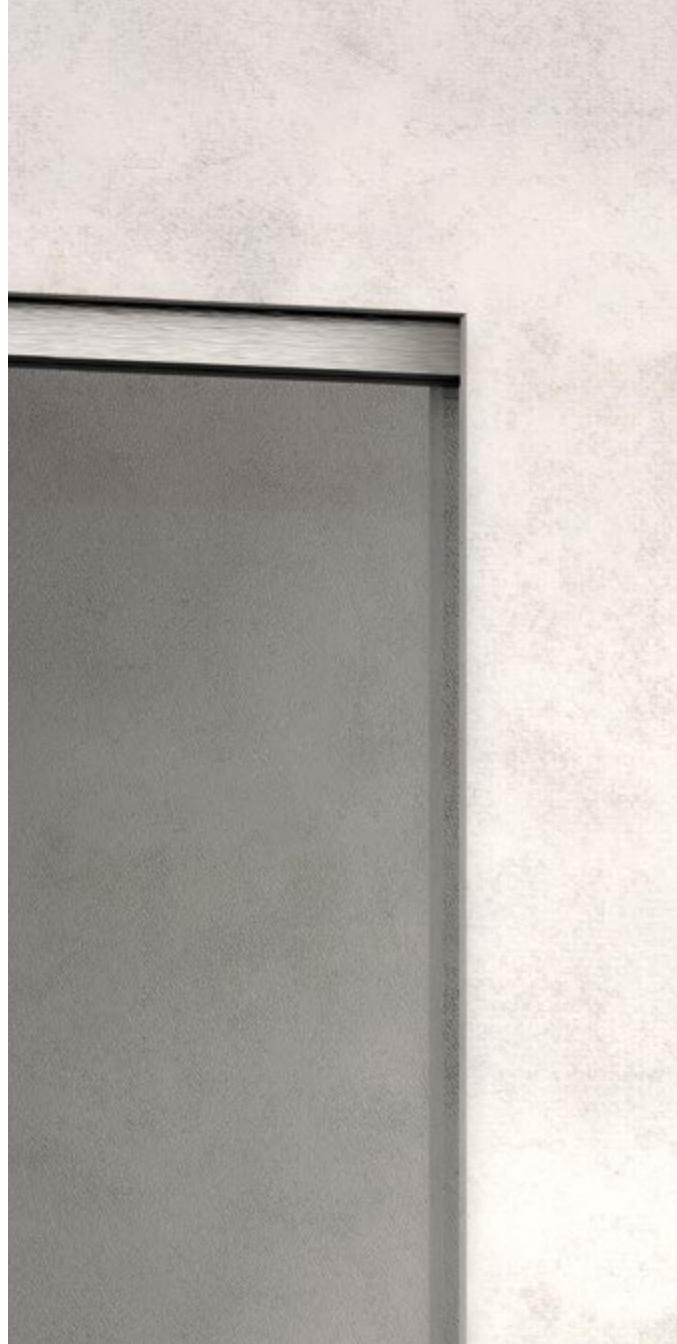

# DYANA

## VISIONI PROFILE

SCORREVOLE INTERNO MURO SENZA TELAIO



**Visioni Profile**

Porta scorrevole interno muro senza telaio  
Vetro trasparente extrachiaro con profili alluminio  
Maniglione MAN-PR28 alluminio

**Visioni Profile**

*Internal wall sliding door without frame  
Extra clear glass with aluminum profiles  
MAN-PR28 aluminum pull handle*







# SCORREVOLE INTERNO MURO CON TELAIO **VENERE**

**Finiture disponibili**



**Caratteristiche tecniche**

Portata massima 100 Kg/anta  
 Altezza massima anta 3000 mm  
 Larghezza massima binario 400 mm

**Technical features**

Maximum load 100 Kg/leaf  
 Maximum height door 3000 mm  
 Minimum door width 400 mm

**Versioni disponibili**  
*Versions available*

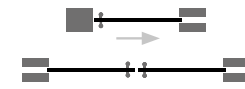

Per ulteriori informazioni tecniche consulta la scheda tecnica sul listino - For further technical information consult the technical data sheet on the price list

**Porta scorrevole interno muro Venere**  
*Venere internal sliding door*

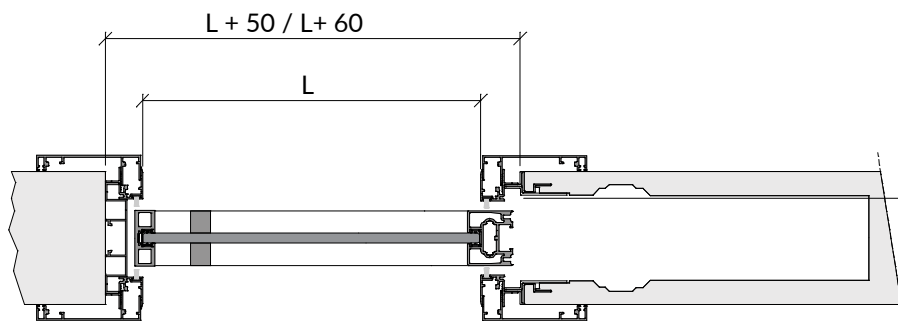

**Porta scorrevole interno muro Venere**  
*Venere internal sliding door*

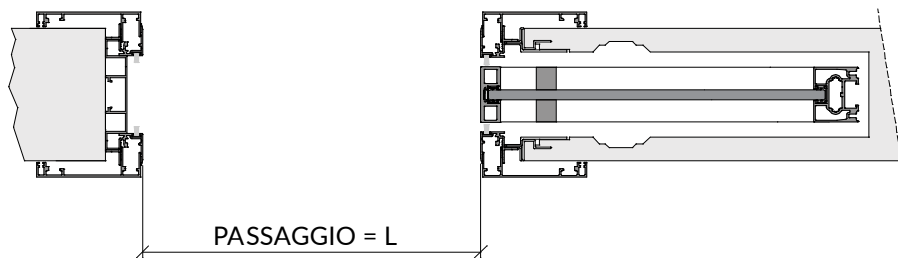

**Sezione verticale**  
*Vertical section*

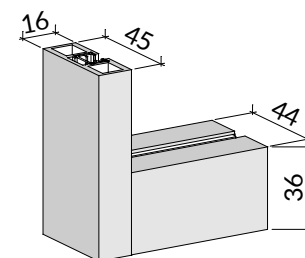
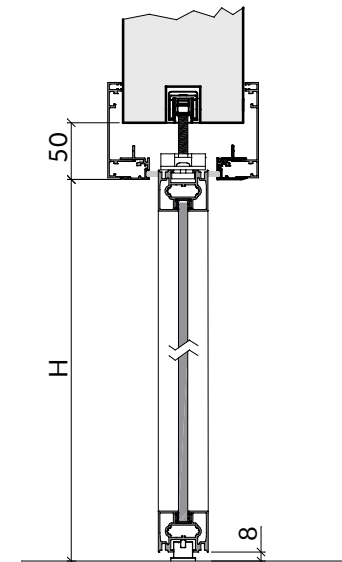

# SCORREVOLE INTERNO MURO SENZA TELAIO **DYANA**

## Finiture disponibili



### Caratteristiche tecniche

Portata massima 100 Kg/anta  
 Altezza massima anta 3000 mm  
 Larghezza minima anta 400 mm

### Technical features

Maximum load 100 Kg/leaf  
 Maximum height door 3000 mm  
 Minimum door width 400 mm

## Versioni disponibili Versions available

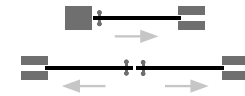

## Porta scorrevole interno muro Dyana Dyana internal sliding door

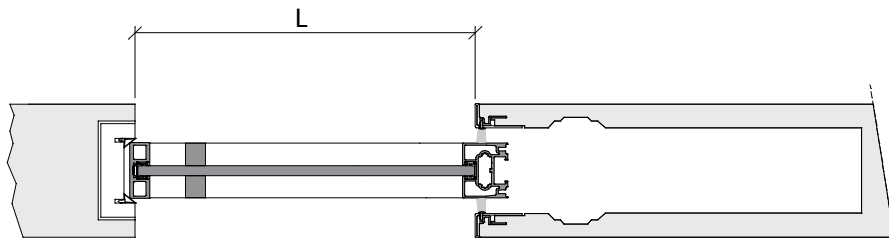

## Porta scorrevole interno muro Dyana Dyana internal sliding door

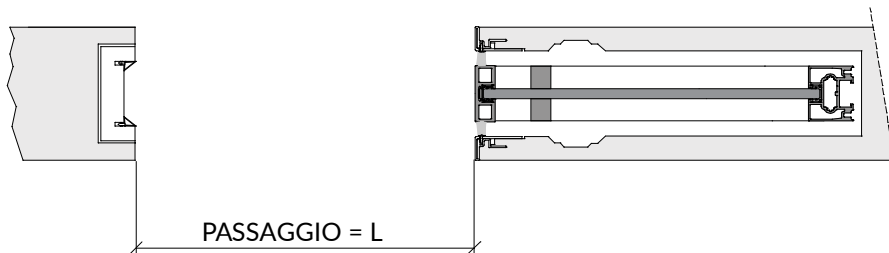

## Sezione verticale Vertical section

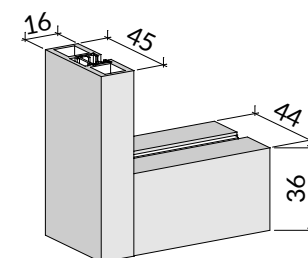
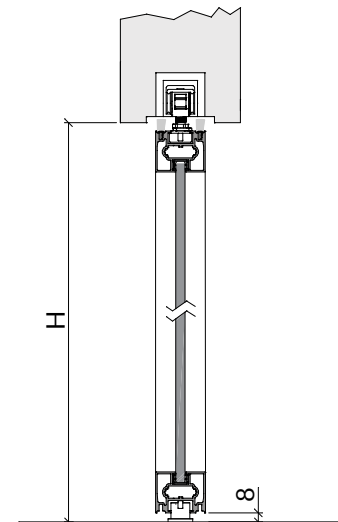

Per ulteriori informazioni tecniche consulta la scheda tecnica sul listino - For further technical information consult the technical data sheet on the price list



IRIS:  
il fulcro del design  
Una porta pivot in  
vetro con profili che  
funge da fulcro nel tuo  
spazio, trasformando  
ogni apertura in un  
atto di eleganza e  
innovazione

IRIS:  
*the fulcrum of design*  
*A pivot glass door*  
*with profiles that acts*  
*as a fulcrum in your*  
*space, transforming*  
*every opening into an*  
*act of elegance and*  
*innovation*



# IRIS

## VISIONI PROFILE

PORTA A BILICO PIVOT



**Visioni Profile**  
Porta a bilico pivot  
Vetro trasparente bronzo con profili sohara  
Sistema di apertura bilico decentrata

**Visioni Profile**  
*Pivot door*  
*Transparent bronze glass with sohara profiles*  
*Decentralized pivot opening system*











# PORTA A BILICO PIVOT IRIS



## Iris con cerniera a filo anta

### Finiture disponibili



### Caratteristiche tecniche

- Portata massima 100 Kg/anta
- Chiusura oleodinamica
- Larghezza massima passaggio 1000 mm
- Larghezza massima anta 1000 mm

### Technical features

- Maximum load 100 Kg/leaf
- Hydraulic closing
- Maximum passage width 1000 mm
- Maximum door width 1000 mm



## Iris con cerniera decentrata

### Finiture disponibili



### Caratteristiche tecniche

- Portata massima 100 Kg/anta
- Chiusura oleodinamica
- Larghezza massima passaggio 1000 mm
- Larghezza massima anta 1600 mm

### Technical features

- Maximum load 100 Kg/leaf
- Hydraulic closing
- Maximum passage width 1000 mm
- Maximum door width 1600 mm

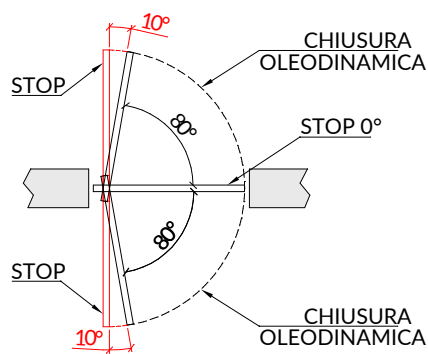

## Versioni disponibili

### Versions available

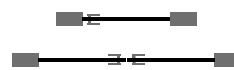

### Sezione verticale muro a vista

Vertical section exposed wall

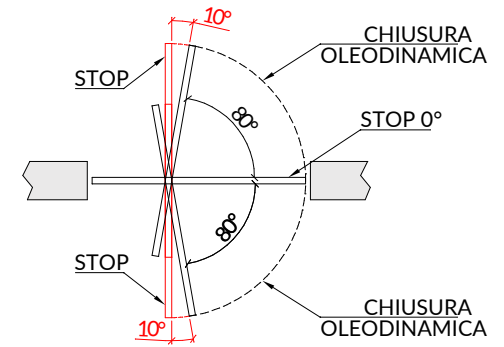
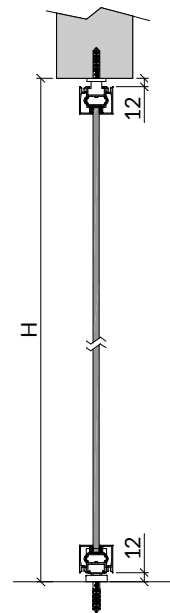

## Iris con cerniera a filo anta, muro a vista

Iris with flush hinge, exposed wall

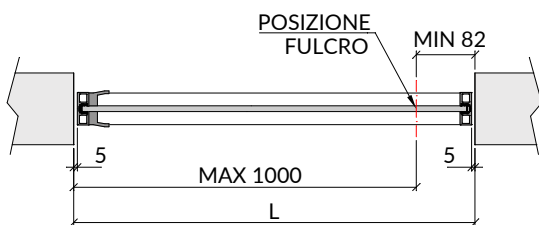

## Iris con cerniera decentrata, muro a vista

Iris with decentralized hinge, exposed wall

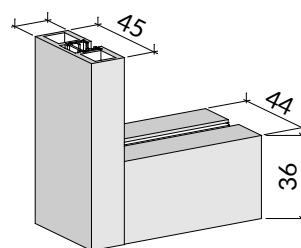
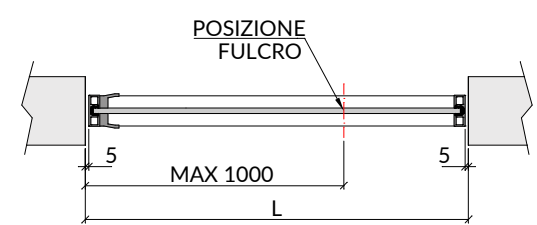

Per ulteriori informazioni tecniche consulta la scheda tecnica sul listino - For further technical information consult the technical data sheet on the price list







HARPA:  
l'incarnazione della  
bellezza funzionale,  
una Porta a battente  
in vetro con profili e  
telaio, che combina  
estetica e solidità per  
un ambiente di classe

*HARPA:  
the embodiment of  
functional beauty,  
a glass swing  
door with profiles  
and frame, which  
combines aesthetics  
and solidity for a  
classy environment*

# HARPA

## VISIONI PROFILE

P O R T A   A   B A T T E N T E

**Visioni Profile**

Porta a battente con serratura orizzontale  
Vetro trasparente extrachiario con profilo verniciato bianco  
Telaio TN bianco Ral 9016

**Visioni Profile**

*Swing door with horizontal lock  
Extra-clear transparent glass with white painted profile  
White Ral 9016 TN frame*







# PORTA A BATTENTE HARPA

## Finiture disponibili



**Caratteristiche tecniche**  
 Portata massima 60 Kg/anta  
 Altezza massima anta 2700 mm  
 Larghezza massima anta 900 mm

**Technical features**  
 Maximum load 60 Kg/leaf  
 Maximum height door 2700 mm  
 Maximum door width 900 mm

## Versioni disponibili

Versions available

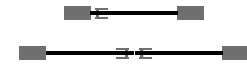

**Telai disponibili vedi pag 104**  
 Available frames see page 104

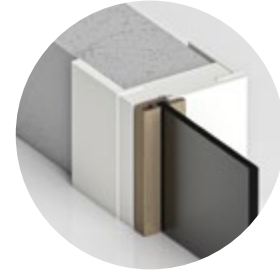

Per ulteriori informazioni tecniche consulta la scheda tecnica sul listino - For further technical information consult the technical data sheet on the price list

### Porta a battente Harpa con telaio in legno

Harpa swing door with wooden frame

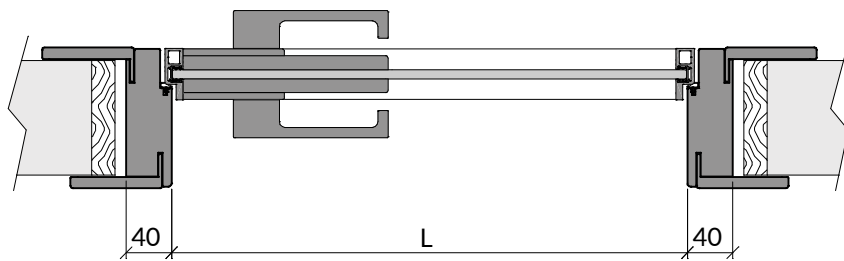

### Porta a battente Harpa con telaio raso muro

Harpa swing door with flush-fitting frame

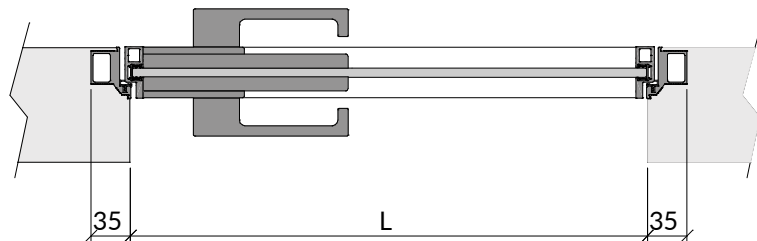

### Harpa con telaio in legno

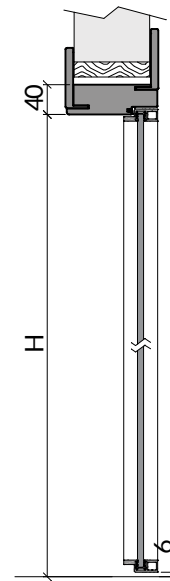

### Harpa con telaio raso muro

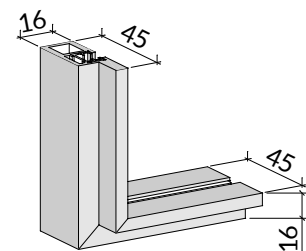
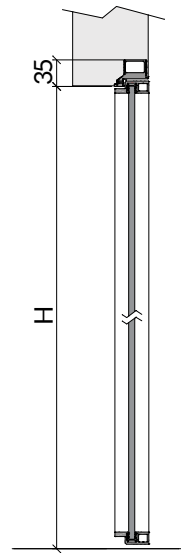



ANTILIA:  
l'arte dell'essenzialità,  
una porta in vetro  
battente che unisce  
semplicità e raffinatezza  
per un ambiente  
moderno  
ed accogliente

ANTILIA:  
*the art of essentiality,  
a swing glass door  
which combines  
simplicity and  
refinement for a  
modern environment*



# ANTILIA

## VISIONI PROFILE

PORTA A BATTENTE

**Visioni Profile**

Porta a battente con serratura verticale  
profilo Standard bronzo  
vetro Extrachiaro trasparente

**Visioni Profile**

*Swing door with vertical lock  
Standard Bronze profiles,  
Extra-clear transparent glass*

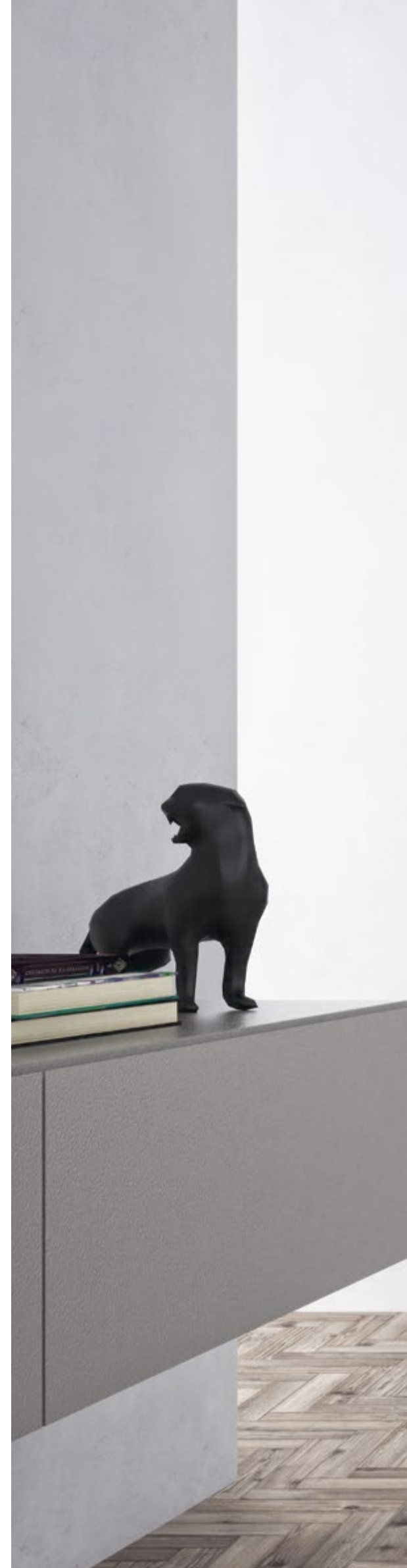

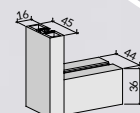

Profilo *Standard*

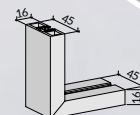
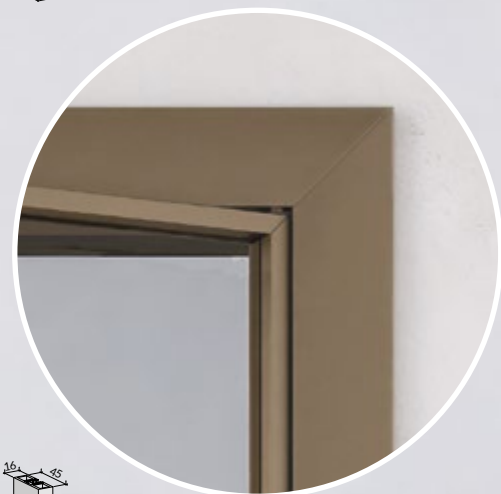

Profilo *Lite*





# PORTA A BATTENTE **ANTILIA** con profilo *Standard*

## Finiture disponibili



## Caratteristiche tecniche

Portata massima 60 Kg/anta  
 Altezza massima anta 2700 mm  
 Larghezza massima anta 900 mm

## Technical features

Maximum load 60 Kg/leaf  
 Maximum height door 2700 mm  
 Maximum door width 900 mm

## Versioni disponibili

Versions available

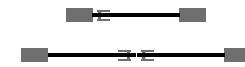

Telai disponibili vedi pag 104  
 Available frames see page 104

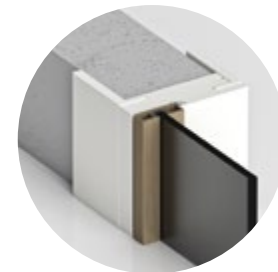

Per ulteriori informazioni tecniche consulta la scheda tecnica sul listino - For further technical information consult the technical data sheet on the price list

## Porta a battente Antilia con telaio in legno

Antilia swing door with wooden frame

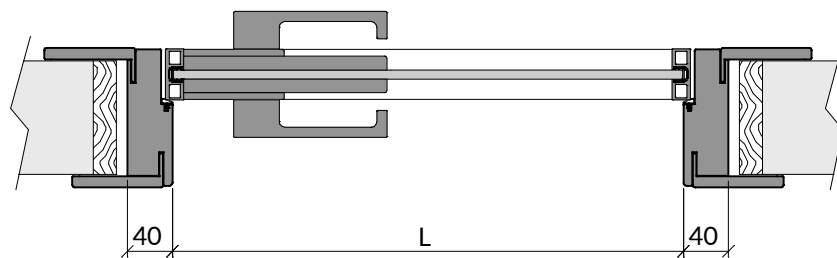

## Porta a battente Antilia con telaio in alluminio

Antilia swing door with aluminum frame

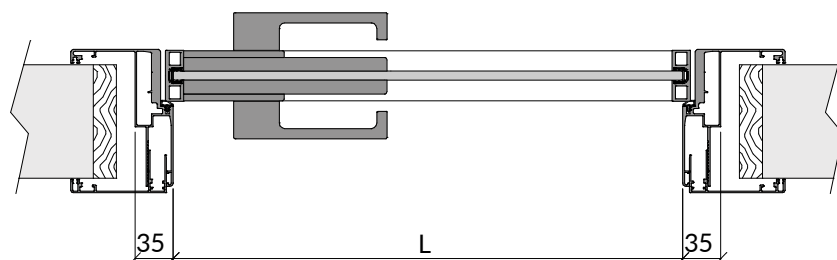

## Antilia con telaio in legno

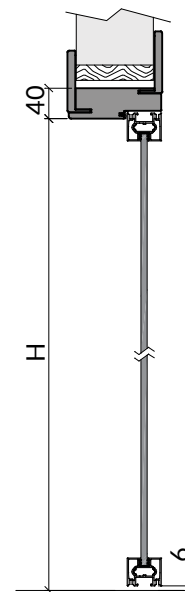

## Antilia con telaio in alluminio

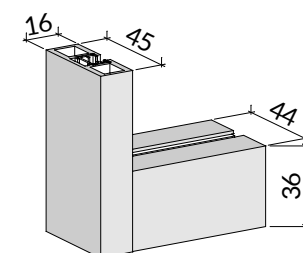
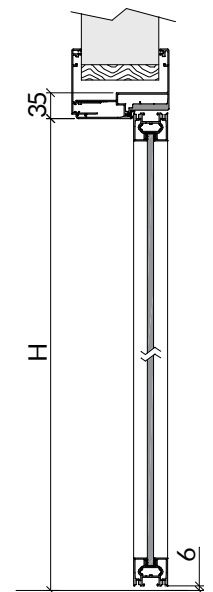

# PORTA A BATTENTE **ANTILIA** con profilo *Lite*

## Finiture disponibili



### Caratteristiche tecniche

Portata massima 60 Kg/anta  
 Altezza massima anta 2700 mm  
 Larghezza massima anta 900 mm

### Technical features

Maximum load 60 Kg/leaf  
 Maximum height door 2700 mm  
 Maximum door width 900 mm

## Versioni disponibili Versions available

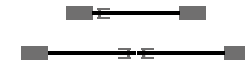

## Telai disponibili vedi pag 104 Available frames see page 104

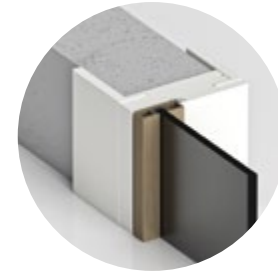

Per ulteriori informazioni tecniche consulta la scheda tecnica sul listino - For further technical information consult the technical data sheet on the price list

### Porta a battente Antilia con telaio in legno Antilia swing door with wooden frame

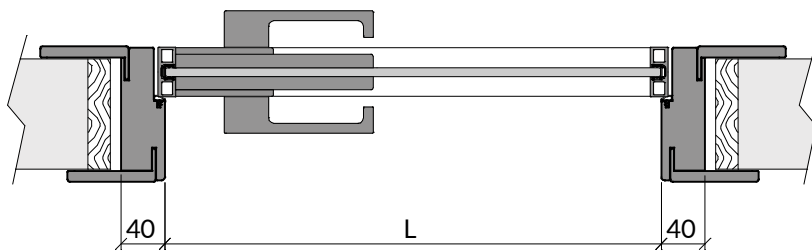

### Porta a battente Antilia con telaio in alluminio Antilia swing door with aluminum frame

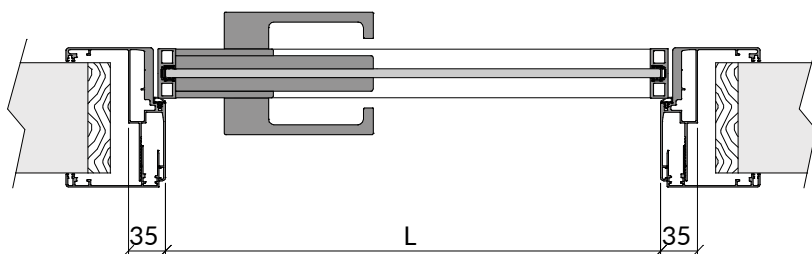

### Antilia con telaio in legno

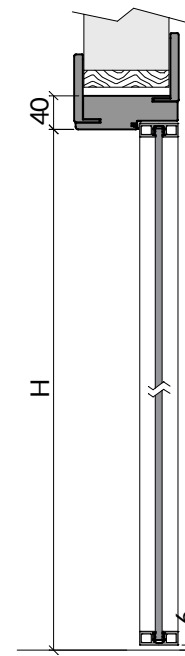

### Antilia con telaio in alluminio

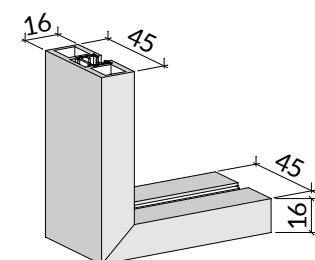
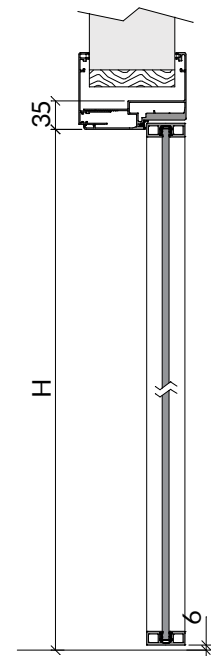



# TELAI **BATTENTI** per porte *Visioni Profile*

 **Telaio TN**  
in legno/wood

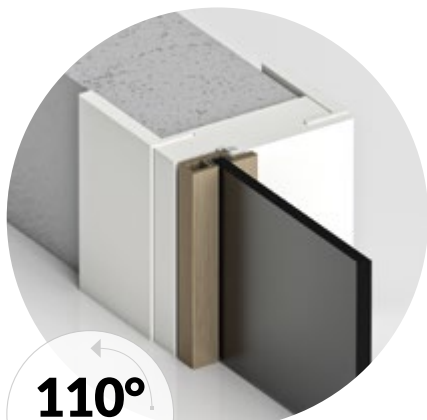

**110°**

Angolo max di apertura  
MAX OPENING ANGLE

- Harpa
- Antilia

 **Telaio TS**  
in legno/wood

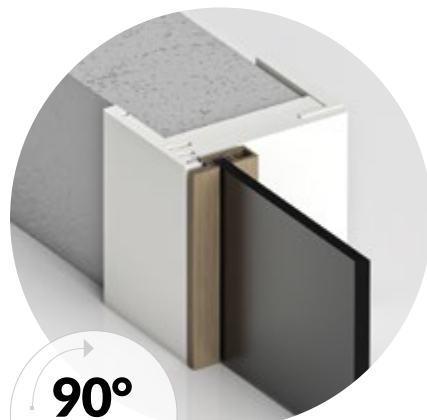

**90°**

Angolo max di apertura  
MAX OPENING ANGLE

- Harpa
- Antilia

 **Telaio TSP**  
in legno/wood

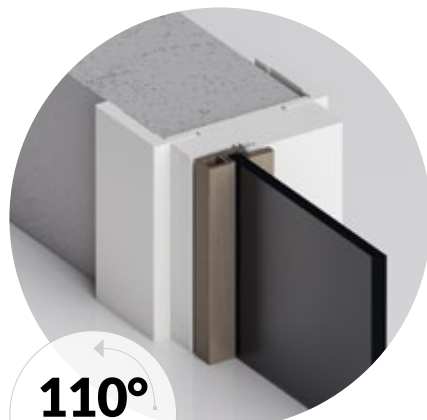

**110°**

Angolo max di apertura  
MAX OPENING ANGLE

- Harpa
- Antilia

 **Telaio TX**  
in legno/wood

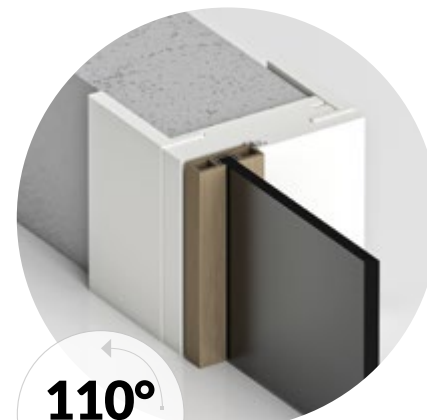

**110°**

Angolo max di apertura  
MAX OPENING ANGLE

- Harpa
- Antilia

 **Telaio TXS**  
in legno/wood

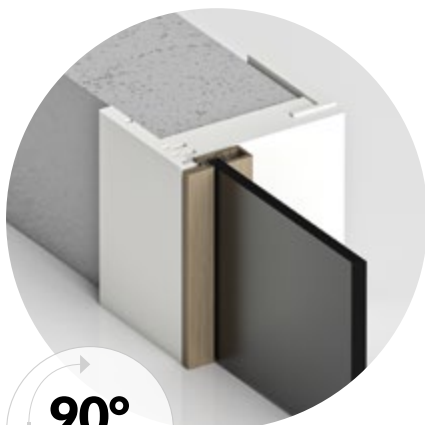

**90°**

Angolo max di apertura  
MAX OPENING ANGLE

- Harpa
- Antilia

 **Telaio TA**  
in alluminio/aluminium



**110°**

Angolo max di apertura  
MAX OPENING ANGLE

- Harpa
- Antilia

 **Telaio RSN**  
rasomuro/close to the wall

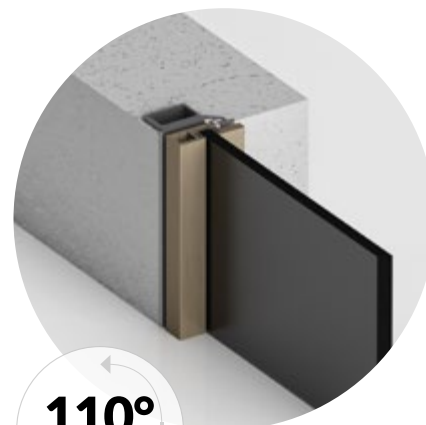

**110°**

Angolo max di apertura  
MAX OPENING ANGLE

- Harpa
- Antilia

# Tipologie di **APERTURA** per porte *Visioni Profile*



Scorrevole esterno muro *Velo*



Scorrevole esterno muro *Nexus*



Scorrevole esterno muro *Masca*



Scorrevole interno muro *Venere*



Scorrevole interno muro *Dyana*



Porta bilico pivot *Iris*



Porta a battente *Harpa*



Porta a battente *Antilia*







# IL VETRO OLTRE I SUOI CONFINI

Viaggia oltre i confini dell'estetica tradizionale con i modelli Profile Industrial di Visioni, dalle texture del Rovere Touch alle trame metalliche, ai vetri materici, esplora il futuro del design

*Travel beyond the boundaries of traditional aesthetics with Visioni's Profile Industrial models From the textures of Touch Oak to metal textures and material glass, explore the future of design*



**Visioni Profile**  
Porta doppia scorrevole opposta  
esterno muro **Wood3**  
con profili black  
Vetro trasparente extrachiario  
Sistema di scorrimento **Velo**

**Visioni Profile**  
*Double sliding door outside the  
wall Wood 3 with black profiles  
Extra-clear transparent glass  
Velo sliding system*



# VETRO E LEGNO

GLASS AND WOOD

Il vetro incornicia  
il legno, creando  
un quadro di  
armoniosi contrasti

THE GLASS FRAMES WOOD,  
CREATING A PAINTING OF  
HARMONIOUS CONTRASTS





**Visioni Profile**  
 Porta a battente **Antilia**,  
 Vetro trasparente extrachiario  
 Modello **Wood1**  
 con profili standard black

**Visioni Profile**  
 Antilia swing door,  
 Extra-clear transparent glass  
 Wood1 model  
 with standard Black profiles



**Visioni Profile**  
Wood1



**Visioni Profile**  
Wood2



**Visioni Profile**  
Wood3



**Visioni Profile**  
Wood4



**Visioni Profile**  
Wood5



**Visioni Profile**  
Wood6



**Visioni Profile**  
Wood7

**Visioni Profile**  
Porta a battente **Harpa**,  
vetro satinato extrachiario  
Modello **Wood6**

**Visioni Profile**  
*Harpa swing door,  
Extra-clear satin glass  
Wood6 model*







**Visioni Profile**  
 Porta battente rasomuro **Harpa**  
 vetro **Chocolate Canvas**  
 con profili verniciati moon  
 Serratura orizzontale

**Visioni Profile**  
*Harpa flush-fitting hinged door*  
*Chocolate Canvas glass*  
*with moon painted profiles*  
*Horizontal lock*



**Visioni Profile**  
 Porta doppia scorrevole interno  
 passata su ante fisse  
 vetro **Cream Canvas**  
 con profili verniciati sohara  
 Maniglia MAN-PR28

**Visioni Profile**  
*Internal sliding double door*  
*passed on fixed doors*  
*Glass Cream Canvas*  
*with sohara painted profiles*  
*MAN-PR28 handle*

# VETRO E TESSUTO

GLASS AND CANVAS

Trasparenze  
 intrecciate in un  
 legame sottile

TRANSPARENCIES  
 INTERTWINED IN ONE  
 SUBTLE BOND





**Visioni Profile**  
Porta scorrevole esterno muro  
Sistema di scorrimento **Velo**  
con profili verniciati akenar  
Vetro **Desert Canvas**  
Maniglia MAN-PR28

**Visioni Profile**  
External wall sliding door  
Velo sliding system  
with akenar painted profiles  
Desert Canvas glass  
MAN-PR28 handle

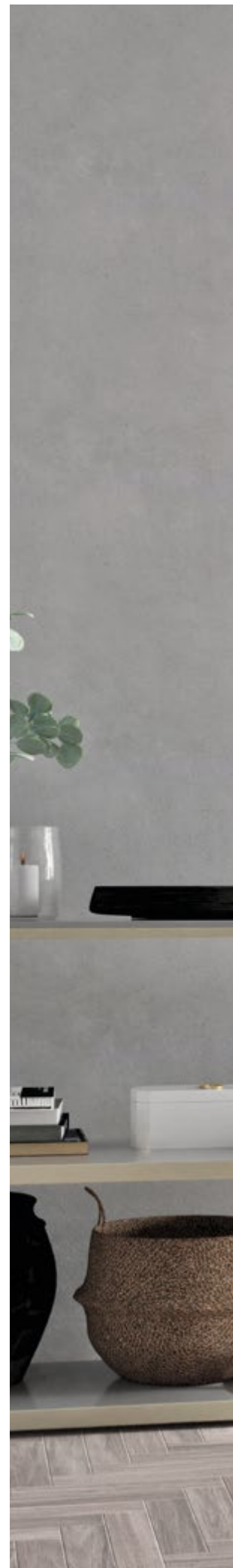

**Visioni Profile**  
Porta a battente **Harpa**  
Vetro **Lijnen Canvas**  
con profili verniciati bianchi  
Serratura orizzontale

**Visioni Profile**  
Hinged door **Harpa**  
Lijnen Canvas glass  
with white painted profiles  
Horizontal lock





# VETRO A SCACCHI

GLASS CHESS

Lo stile  
"Industrial"  
di Visoni Profile

THE "INDUSTRIAL" STYLE  
OF VISIONI PROFILE



**Visioni Profile**

Porta scorrevole interno passata su anta fissa  
Vetro satinato extrachiaro, modello **Unsquare 5**  
con profili verniciati blue marine

**Visioni Profile**

*Internal sliding door passed on fixed door  
Extra-clear satin glass, Unsquare 5 model  
with blue marine painted profiles*







**Visioni Profile**  
 Porta scorrevole esterno muro  
 Vetro trasparente extrachiario  
 Modello **Unsquare1** con profili black  
 Sistema di scorrimento **Velo**  
 Maniglia MAN-PR28

**Visioni Profile**  
 External wall sliding door  
 Extra-clear transparent glass  
 Unsquare1 model with black profiles  
 Velo sliding system  
 MAN-PR28 handle



**Visioni Profile**  
 Unsquare 1

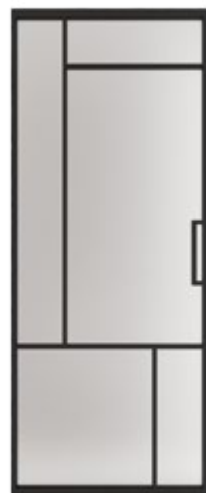

**Visioni Profile**  
 Unsquare 2

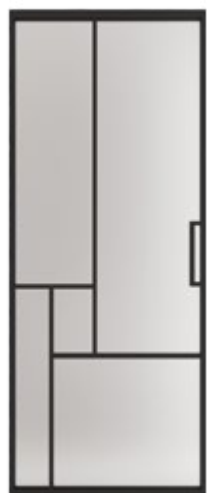

**Visioni Profile**  
 Unsquare 3



**Visioni Profile**  
 Unsquare 4



**Visioni Profile**  
 Unsquare 5

Visioni Profile  
Porta scorrevole esterno muro  
Vetro trasparente extrachiaro  
Modello **Unsquare3** con profili alluminio  
Sistema di scorrimento **Velo**  
Maniglia MAN-PR28

*Visioni Profile  
External wall sliding door  
Extra-clear transparent glass  
Unsquare3 model with aluminum profiles  
Velo sliding system  
MAN-PR28 handle*





Visioni Profile  
Porta scorrevole esterno muro  
vetro trasparente extrachiaro  
Modello **Square6** con profili bronzo  
Sistema di scorrimento **Nexus**  
Maniglia MAN-PR28

**Visioni Profile**  
*External wall sliding door  
Extra-clear transparent glass  
Square6 model with bronze profiles  
Nexus sliding system  
MAN-PR28 handle*





Visioni Profile  
 Porta doppia scorrevole opposta esterno muro  
 Vetro trasparente extrachiario  
 modello **Square5** con profili standard black  
 Sistema di scorrimento **Velo**  
 Maniglia MAN-PR28

**Visions Profile**  
 Double sliding door opposite external wall  
 Extra-clear transparent glass  
 Square5 model with standard black profiles  
 Velo sliding system  
 MAN-PR28 handle



Visioni Profile  
 Square 1



Visioni Profile  
 Square 2

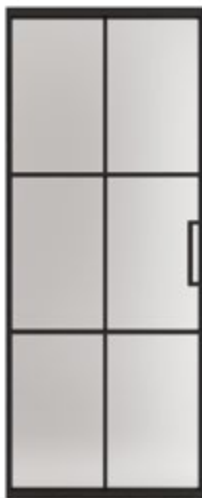

Visioni Profile  
 Square 3



Visioni Profile  
 Square 4



Visioni Profile  
 Square 5

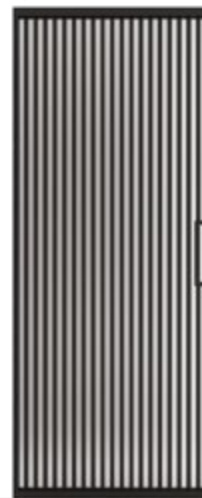

Visioni Profile  
 Square 6



**Visioni Profile**

Porta quadrupla scorrevole esterno muro  
trascinata opposta con profili alluminio  
Vetro **Lite connection** trasparente bronzo  
Sistema di scorrimento **Nexus**  
Maniglia MAN-PR28

**Visioni Profile**

*Quadruple sliding door outside the wall,  
opposite dragging with aluminum profiles  
Lite connection glass Transparent bronze  
Nexus sliding system  
MAN-PR28 handle*







# LA RETE NEL VETRO

THE NET IN THE GLASS

Il vetro con un cuore  
d'acciaio, elegante e  
raffinato, per ambienti  
di gran classe

GLASS WITH A HEART OF STEEL,  
ELEGANT AND REFINED, FOR  
HIGH-CLASS ENVIRONMENTS







**Visioni Profile**

Porta doppia battente **Antilia**  
Vetro **Wide Connection** trasparente extrachiario  
con profili anodizzati e telaio TA  
Maniglia Minimal SM

**Visioni Profile**

Double swing door **Antilia**  
*Wide Connection* glass extra-clear transparent  
with knotted profiles and frame TA  
Minimal SM handle



**Visioni Profile**

Porta doppia scorrevole  
interno passata su anta fissa  
Vetro **Medium Connection** Trasparente grigio  
con profili verniciati light grey  
Sistema di scorrimento **Velo** a soffitto  
Maniglia MAN-PR28

**Visioni Profile**

Internal double sliding door  
passed on fixed leaf  
*Medium Connection* Transparent gray glass  
with light grey painted profiles  
*Velo* ceiling sliding system  
MAN-PR28 handle





**Visioni Profile**

Porta a battente Antilia  
Vetro **Kamyl** trasparente bronzo  
con profili dark bronze  
Serratura verticale

**Visioni Profile**

Antilia swing door  
Bronze transparent Kamyl glass  
with dark bronze profiles  
Vertical lock



Vetro **Stowe** extrachiario  
Extra-clear Stowe glass

# VETRO IN RILIEVO

GLASS IN RELIEF

L'espressione  
materica del  
vetro prende  
forma

THE MATERIAL EXPRESSION  
OF GLASS TAKES SHAPE



**Visioni Profile**

Porta scorrevole esterno muro  
Vetro **Stowe** extrachiaro  
con profili verniciati antique brass  
Sistema di scorrimento **Nexus**  
Maniglia MAN-PR28

**Visioni Profile**

External wall sliding door  
Extra-clear **Stowe** glass  
with antique brass painted profiles  
**Nexus** scroll system  
MAN-PR28 handle











**Visioni Profile**

Porta scorrevole esterno muro **Velo**  
Vetro **Kostel** trasparente extrachiario  
con profili verniciati bianchi  
Maniglia MAN-PR28

**Visioni Profile**

*Velo external wall sliding door  
Extra-clear transparent Kostel glass  
with white painted profiles  
MAN-PR28 handle*



**Visioni Profile**

Porta doppia scorrevole interno passata su ante fisse  
Vetro **Hays** trasparente extrachiario  
con profili verniciati blue marine  
Sistema di scorrimento **Velo** a soffitto  
Maniglia MAN-PR28

**Visioni Profile**

*Internal sliding double door on fixed leaves  
Hays glass extra-clear transparent  
with blue marine painted profiles  
Velo ceiling sliding system  
MAN-PR28 handle*





# IL VETRO ED I COLORI

Dipingi con la luce e i colori.  
Entra nel mondo magico  
delle decorazioni vetro, dove  
la luce e il colore si fondono  
per creare opere uniche

*Paint with light and colors.  
Enter the magical world of glass decorations, where  
light and color blend to create unique works*





# LINEARITÀ DINAMICHE

DYNAMIC LINEARITIES

L'eleganza dei modelli esclusivi  
Visioni su porte in vetro,  
dove semplici tratti creano  
un'estetica pulita e moderna,  
trasformando gli spazi con uno  
stile senza tempo

*The elegance of our linear models  
on glass doors, where simple  
lines create a clean and modern  
aesthetic, transforming spaces  
with a timeless style*

## **Visioni**

Porta doppia scorrevole opposta  
Decoro lucido **Linha** (LN07). Lavorazione AT  
Vetro satinato extrachiario  
Sistema di scorrimento **Essenza**  
Maniglione MAN-T66 Inox Satinato

## **Visioni**

*Opposite double sliding door  
Shiny Linha decoration (LN07). AT workmanship  
Extra-clear satin glass  
Essenza sliding system  
MAN-T66 Satin Stainless Steel Handle*

Visioni  
Porta a battente **Style**  
Decoro **Blades** (LN11) trasparente fondo sabbiato - Lavorazione ST  
(disponibile anche nella versione Satcolor Ceramico)  
Serratura Style MN

**Visioni**  
Style swing door  
Blades decoration (LN11) transparent sandblasted background - ST processing  
(also available in the Satcolor Ceramico version)  
Style MN lock







**Visioni**

Porta scorrevole esterno muro  
 Decoro **Layer** (LN09) antracite. Lavorazione AD  
 Sistema di scorrimento **Cubo Fluid**  
 Maniglione MAN-Q46 inox satinato

**Visioni**

External wall sliding door  
 Anthracite Layer decoration (LN09). AD workmanship  
 Cubo Fluid sliding system  
 MAN-Q46 satin stainless steel handle

Visioni

Porta a battente **Athena**  
 Decoro sabbato **Three** (LN05)  
 vetro satinato grigio  
 Lavorazione AS  
 Serratura Athena ATM

**Visioni**

Athena swing door  
 Sandblasted decoration Three (LN05)  
 gray satin glass  
 AS workmanship  
 Athena ATM lock





**Visioni**  
Porta scorrevole esterno muro  
Decoro **Laser** (LN15) satcolor cielo e trasparente  
fondo satcolor satinato - Lavorazione AD  
Sistema di scorrimento **Luna Soft Close**  
Maniglione MAN-T66

**Visioni**  
*External wall sliding door  
Laser decoration (LN15)  
satin sky color and transparent  
satin satin background - AD workmanship  
Luna Soft Close sliding system  
MAN-T66 handle*



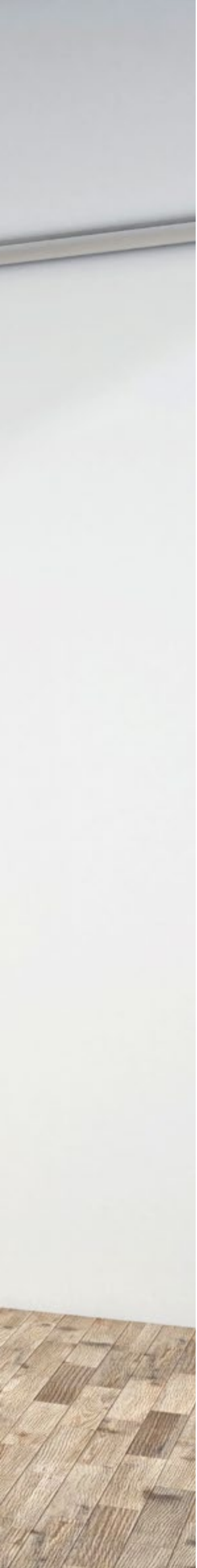

**Visioni**  
Porta a battente **Style** rasomuro  
Decoro **Three** (LN05) abbiato  
Vetro trasparente bronzo  
Lavorazione TS  
Maniglione MAN-Q116

**Visioni**  
*Style flush-to-the-wall swing door*  
*Sandblasted Three (LN05) decoration*  
*Transparent bronze glass*  
*TS workmanship*  
*MAN-Q116 handle*





**Visioni**

Porta scorrevole esterno muro  
Decoro **Laser** (LN15) sabbiato. Lavorazione AS  
Vetro satinato grigio  
Sistema di scorrimento **Puro Soft Close**  
Maniglione MAN-T46 inox satinato

**Visioni**

*External wall sliding door  
Sandblasted laser decoration (LN15). AS workmanship  
Gray satin glass  
Puro Soft Close sliding system  
MAN-T46 satin stainless steel handle*

**Visioni**

Porta scorrevole esterno muro  
Decoro **Na Kea** (LN16) sabbiato vetro trasparente grigio  
Lavorazione TS - Sistema di scorrimento **Puro Soft Close**  
Maniglione MAN-T46 inox satinato

**Visioni**

*External wall sliding door  
Na Kea decoration (LN16) sandblasted gray transparent glass  
TS workmanship - Puro Soft Close sliding system  
MAN-T46 satin stainless steel handle*







**Visioni**

Porta scorrevole interno passata  
su anta fissa  
Decoro **Rain** (LN21) sabbiato  
Vetro trasparente extrachiario  
Lavorazione TS  
Sistema di scorrimento **Essenza**  
Maniglia VAS-T

**Visioni**

*Internal sliding door passed  
on fixed door  
Sandblasted Rain decoration (LN21)  
Extra-clear transparent glass  
TS workmanship  
Essenza sliding system  
VAS-T handle*



**Visioni**

Porta scorrevole esterno muro  
Decoro **Linah** (LN22) satcolor tortora ed  
effetto satinato vetro trasparente extrachiaro  
Lavorazione TD  
Sistema di scorrimento **Puro Soft Close**  
Maniglione MAN-T30 Inox Satinato

**Visioni**

External wall sliding door  
*Linah* (LN22) satin dove gray decoration and  
satin effect extra-clear transparent glass  
TD workmanship  
Puro Soft Close sliding system  
MAN-T30 satin stainless steel handle







# INTRECCI NATURALI

N A T U R A L   W E A V I N G S

Un'ode alla bellezza, con modelli che riproducono con maestria alberi, rami e fiori Porta l'esterno dentro casa e abbraccia la bellezza della natura

*An ode to beauty, with models that expertly reproduce trees, branches and flowers Bring the outdoors indoors and embrace the beauty of nature*

#### **Visioni**

Porta quadrupla scorrevole  
trascinata opposta esterno muro  
Decoro **Albero** (LN26) sabbiato  
Vetro trasparente extrachiario - Lavorazione TS  
Sistema di scorrimento **Essenza**  
Maniglione MAN-T66

#### **Visioni**

*Quadruple sliding door  
dragged opposite external wall  
Sandblasted Albero decoration (LN26)  
Extra-clear transparent glass - TS workmanship  
Essenza sliding system  
MAN-T66 handle*



**Visioni**

Porta doppia scorrevole esterno muro  
Decoro **Albero** (LN26) sabbiato  
Vetro satinato bronzo - Lavorazione AS  
Sistema di scorrimento **Cubo Fluid**  
Maniglia VAS-Q

**Visioni**

Double sliding door External Wall  
Sandblasted tree decoration (LN26)  
Bronze satin glass - AS workmanship  
Cubo Fluid sliding system  
VAS-Q handle

**Visioni**

Porta scorrevole esterno muro  
Decoro **Albero** (LN26) sabbiato  
Vetro trasparente grigio - Lavorazione TS  
Sistema di scorrimento **Luna Soft Close**  
Maniglione MAN T116

**Visioni**

Sliding door external wall  
Sandblasted Albero decoration (LN26)  
Transparent gray glass - TS workmanship  
Luna Soft Close sliding system  
MAN T116 handle







Visioni  
Porta doppia scorrevole Interno passata  
Decoro **Rami** (LN25) sabbiato  
Vetro satinato grigio - Lavorazione AS  
Sistema di scorrimento **Essenza**  
Maniglia VAS-Q

**Visioni**  
*Internal sliding double door*  
*Sandblasted Rami decoration (LN25)*  
*Gray satin glass - AS workmanship*  
*Essenza sliding system*  
*VAS-Q handle*









Visioni  
Porta doppia scorrevole trascinata su anta fissa interno passata  
Decoro **Rami** (LN25) sabbiato vetro trasparente bronzo - Lavorazione TS  
Sistema di scorrimento a **Veletta** - Maniglione MAN-QC

**Visioni**  
*Double Sliding Door with sliding door on fixed leaf inside passed  
Sandblasted Rami decoration (LN25) Transparent bronze glass - TS workmanship  
Veil sliding system - MAN-QC pull handle*

Visioni  
Porta scorrevole esterno muro  
Decoro **Rami** (LN25) sabbiato  
Vetro trasparente extrachiario  
Lavorazione TS  
Sistema di scorrimento **Essenza**  
Maniglia VAS-T

**Visioni**  
*External wall sliding door*  
*Sandblasted Rami decoration (LN25)*  
*Extra-clear transparent glass*  
*TS workmanship*  
*Essenza sliding system*  
*VAS-T handle*





# SEMPLICITÀ FLOREALI

SIMPLICITY FLORALS

Vetri lavorati con sabbiature  
trasformano gli spazi in  
opere d'arte floreali, unendo  
funzionalità e bellezza

*Sandblasted glass transforms  
spaces into floral works of art,  
combining functionality and beauty*

Visioni  
Porta scorrevole esterno muro  
Decoro **Fiore** (LN27) sabbiato  
Vetro satinato extrachiario - Lavorazione AS  
Sistema di scorrimento **Luna Soft Close**  
Maniglia MAN-T30

**Visioni**  
External wall sliding door  
Sandblasted Fiore decoration (LN27)  
Extra-clear satin glass - AS workmanship  
Luna Soft Close sliding system  
MAN-T30 handle











# ELEMENTI ESSENZIALI

ESSENTIAL ELEMENTS

Modelli che catturano gli  
elementi fondamentali e  
immagini straordinarie, design  
che trasformano gli spazi in  
finestre verso mondi inesplorati  
e atmosfere suggestive

*Models that capture fundamental  
elements and extraordinary images,  
designs that transform spaces into  
windows towards unexplored worlds  
and evocative atmospheres*

## **Visioni**

Porta doppia scorrevole esterno muro  
Decoro **Acqua**  
Satcolor su fondo satinato - Lavorazione AD  
Sistema di scorrimento **Essenza**  
Maniglione MAN-Q66

## **Visioni**

*Double sliding door outside the wall  
Acqua decoration  
Satcolor on satin background - AD workmanship  
Essenza sliding system  
MAN-Q66 handle*



# SCORCI URBANI

GLIMPSES URBAN

La suggestione dell'urbano  
portato direttamente in  
casa crea un'esperienza  
affascinante e  
contemporanea

*The suggestion of the urban  
brought directly into the home  
creates a fascinating and  
contemporary experience*

## **Visioni**

Porta scorrevole esterno muro  
Decoro **Cortona**  
Satcolor su fondo satinato - Lavorazione AD  
Sistema di scorrimento **Cubo Fluid**  
Maniglione MAN-Q46

## **Visioni**

External wall sliding door  
Cortona decoration  
Satcolor on satin background - AD workmanship  
Cubo Fluid sliding system  
MAN-Q46 handle







# SPIRALI COSMICHE

COSMIC SPIRALS

Oasi di serenità e ispirazione  
naturale definiscono gli  
spazi, regalando alla tua casa  
un'atmosfera avvolgente  
ed accogliente

*Oases of serenity and natural  
inspiration define the spaces, giving  
your home an enveloping and  
welcoming atmosphere*

Visioni  
Porta scorrevole esterno muro  
Decoro **Hoola** (LN18) sabbiato  
Vetro satinato extrachiario  
Lavorazione AS  
Sistema di scorrimento **Essenza**  
Maniglione MAN-T66

**Visioni**  
*External wall sliding door  
Sandblasted Hoola decoration (LN18)  
Extra-clear satin glass  
AS workmanship  
Sliding system Essenza  
MAN-T66 handle*











Visioni  
Porta doppia scorrevole opposta  
Decoro **Circle** (LN17) sabbiato  
Vetro trasparente grigio  
Lavorazione TS  
Sistema di scorrimento **Maestro**  
Maniglione MAN-Q66

**Visioni**  
*Opposite double sliding door  
Sandblasted Circle decoration (LN17)  
Transparent gray glass  
TS workmanship  
Maestro sliding system  
MAN-Q66 handle*



**Visioni**  
Porta scorrevole esterno muro  
Decoro **Halaii** (LN20) sabbiato  
Vetro satinato extrachiario  
Lavorazione AS  
Sistema di scorrimento **Essenza**  
Maniglione MAN-T46 inox satinato

**Visioni**  
External wall sliding door  
Sandblasted Halaii decoration (LN20)  
Extra-clear satin glass  
AS workmanship  
Essenza sliding system  
MAN-T46 satin stainless steel handle





Visioni  
Porta doppia scorrevole opposta  
Decoro **Hoola** (LN18) sabbiato  
Vetro trasparente extrachiaro  
Lavorazione TS  
Sistema di apertura **Luna Soft Close**  
Maniglia VAS-T

**Visioni**  
*Opposite double sliding door  
Sandblasted Hoola decoration (LN18)  
Extra-clear transparent glass  
TS workmanship  
Luna Soft Close opening system  
VAS-T Handle*



**Visioni**  
Porta scorrevole esterno muro  
Decoro **Halaii** (LN20) sabbiato  
Vetro trasparente grigio  
Lavorazione TS  
Sistema di scorrimento **Puro Soft Close**  
Maniglione MAN-T66

**Visioni**  
*External wall sliding door  
Sandblasted Halaii decoration (LN20)  
Transparent gray glass  
TS workmanship  
Puro Soft Close sliding system  
MAN-T66 handle*





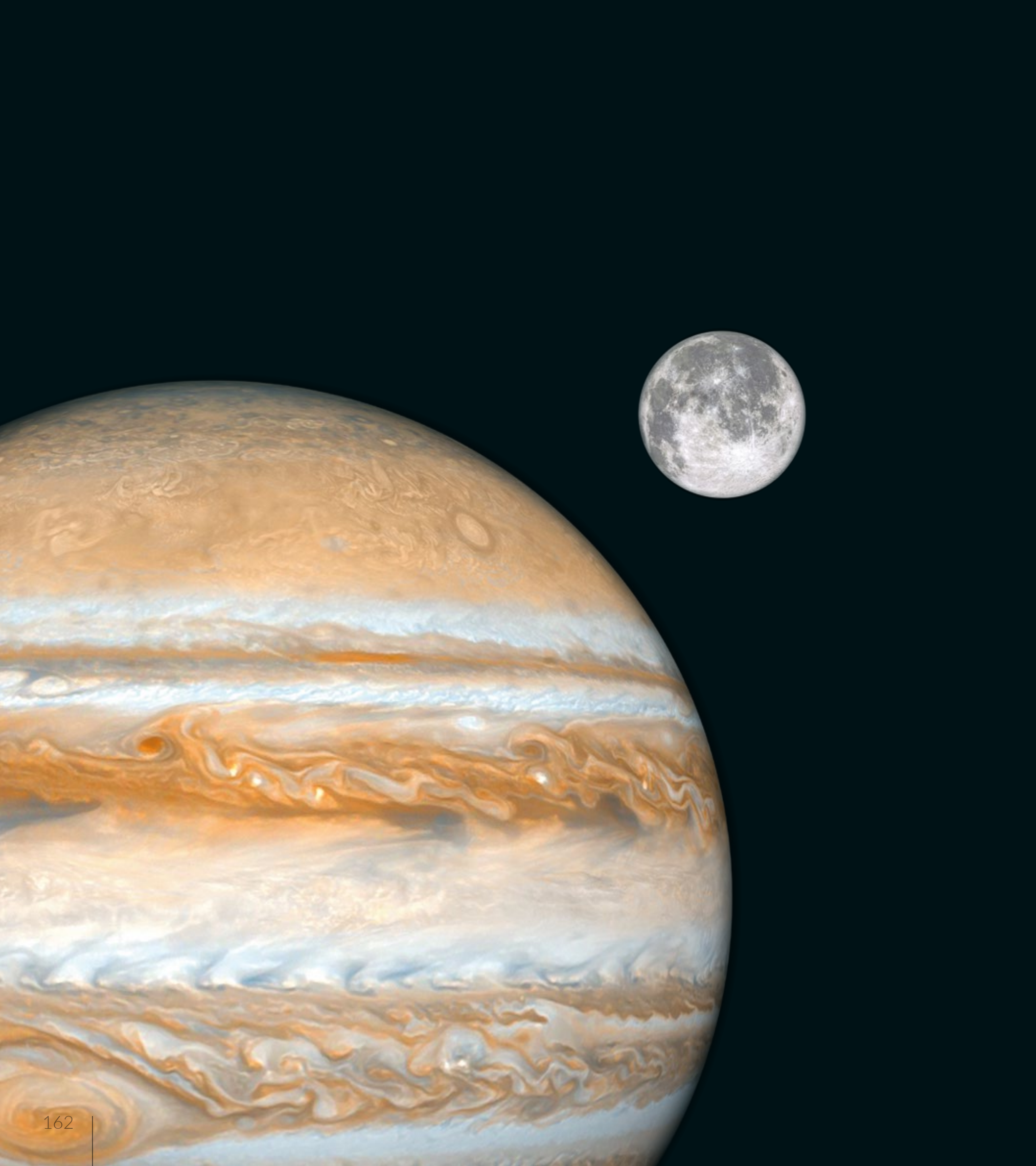



# L'INCONTRO DI DUE MONDI

Immergiti in un mondo di design innovativo con modelli in vetro che riecheggiano fedelmente l'eleganza e la bellezza della versione in legno. La fusione perfetta di tradizione e modernità.

*Immerse yourself in a world of innovative design with glass models that faithfully echo the elegance and beauty of the wooden version. The perfect fusion of tradition and modernity.*





**Visioni Incontro**

Porta scorrevole esterno muro  
Decoro **Waves** (LN01)  
trasparente e sabbiato  
Vetro extrachiaro  
Lavorazione STS  
Sistema di scorrimento **Cubo Fluid**  
Maniglione MAN-Q20 inox satinato

**Visioni Incontro**

External wall sliding door  
Waves decoration (LN01)  
transparent and sandblasted  
Extra-clear glass  
STS workmanship  
Cubo Fluid sliding system  
MAN-Q20 satin stainless  
steel handle

Sololegno **RS06**



**Visioni Incontro**  
 Porta scorrevole interno muro **Paride**  
 Decoro **Line** (LN02)  
 trasparente e sabbiato  
 Vetro bronzo  
 Lavorazione STS - Telaio TN  
 Maniglia VAS-T

**Visioni Incontro**  
*Sliding door inside the Paride wall*  
*Transparent and sandblasted*  
*Line decoration (LN02)*  
*Bronze glass*  
*STS workmanship - TN frame*  
*VAS-T handle*



Sololegno **RS05-i**

**Visioni Incontro**  
 Porta monobattente **Style**  
 Decoro **Laine** (LN03)  
 trasparente e sabbiato  
 Vetro extrachiaro  
 Lavorazione STS - Telaio RSN  
 Serratura Style M

**Visioni Incontro**  
*Style single door*  
*Transparent and sandblasted*  
*Laine decoration (LN03)*  
*Extra-clear glass*  
*STS workmanship - RSN frame*  
*M Style Lock*

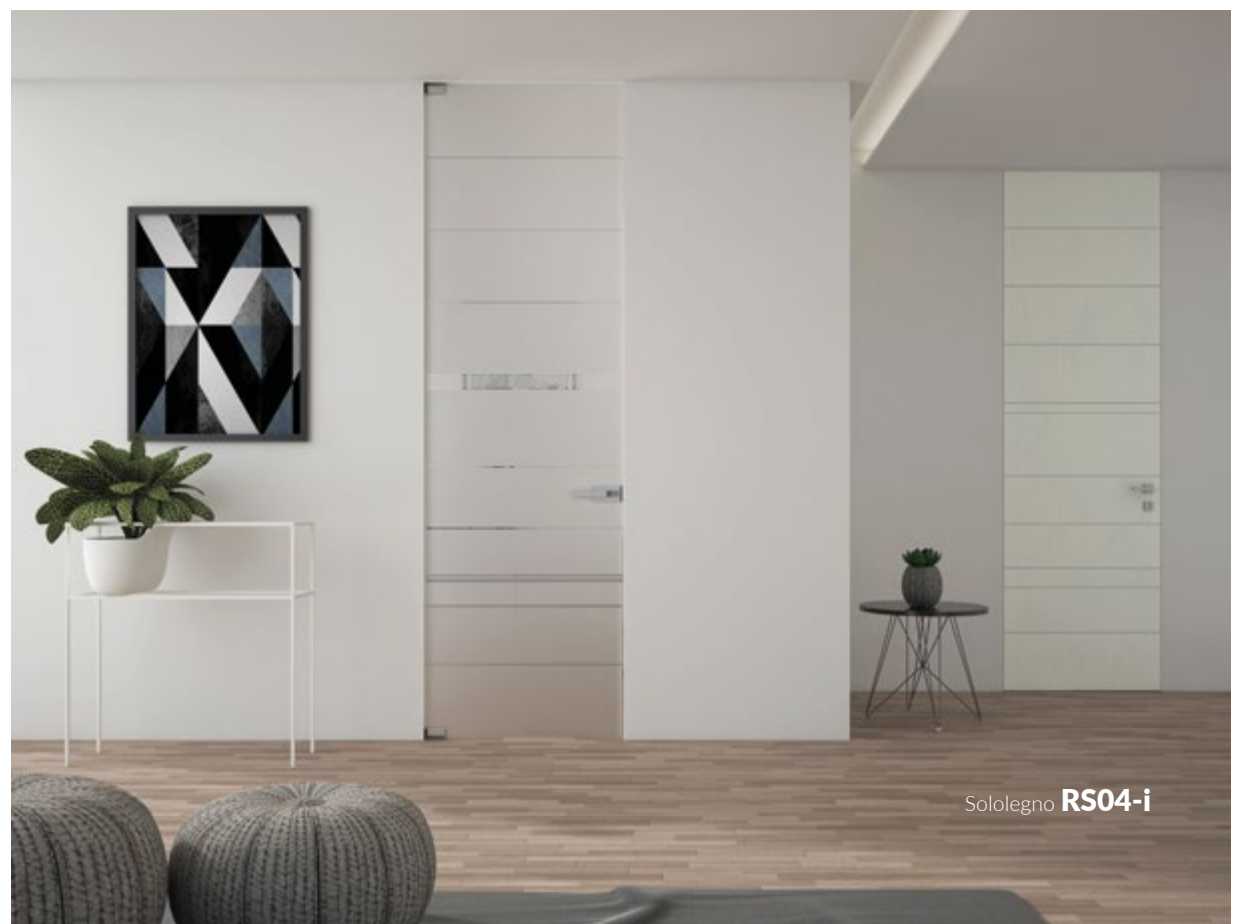

Sololegno **RS04-i**



**Visioni Incontro**

Porta scorrevole esterno muro  
Decoro **V17-G** inciso  
Vetro satinato grigio  
Sistema di scorrimento **Evasione**  
Maniglione MAN-Q20

**Visioni Incontro**

External wall sliding door  
Engraved V17-G decoration  
Gray satin glass  
Scroll system *Evasione*  
MAN-Q20 pull handle



Sololegno **FF22**



Sololegno **FF21**



**Visioni Incontro**

Porta scorrevole esterno muro  
Decoro **V17-H** inciso vetro satinato bronzo  
Sistema di scorrimento **Essenza**  
Maniglione MAN-T116

**Visioni Incontro**

External wall sliding door  
Engraved V17-H decoration Bronze satin glass  
Sliding system *Essenza*  
MAN-T116 pull handle











Sololegno **F167**

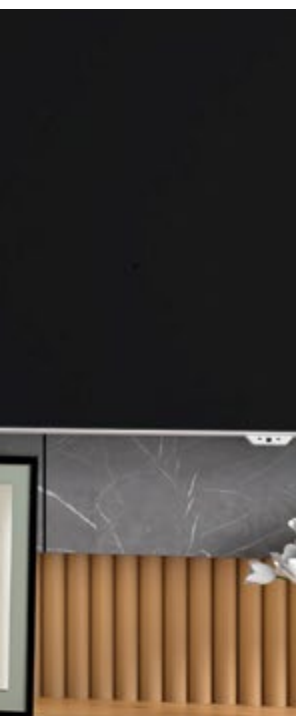

**Visioni Incontro**  
Porta scorrevole interno muro **Paride**  
Decoro **V16-AA** sabbiato  
Vetro satinato extrachiaro  
Telaio TA in alluminio bianco  
Maniglia GSN

**Visioni Incontro**  
Sliding door inside Paride wall  
Sandblasted V16-AA decoration  
Extra-clear satin glass  
White aluminum TA frame  
GSN handle

**Visioni Incontro**  
Porta scorrevole esterno muro  
Decoro **V17-J** inciso  
Vetro satinato extrachiaro  
Sistema di scorrimento **Puro Soft Close**  
Maniglione MAN-T46

**Visioni Incontro**  
External wall sliding door  
Engraved V17-J decoration  
Extra-clear satin glass  
Puro Soft Close sliding system  
MAN-T46 pull handle



Trix **VT11**





Trix **VT19**

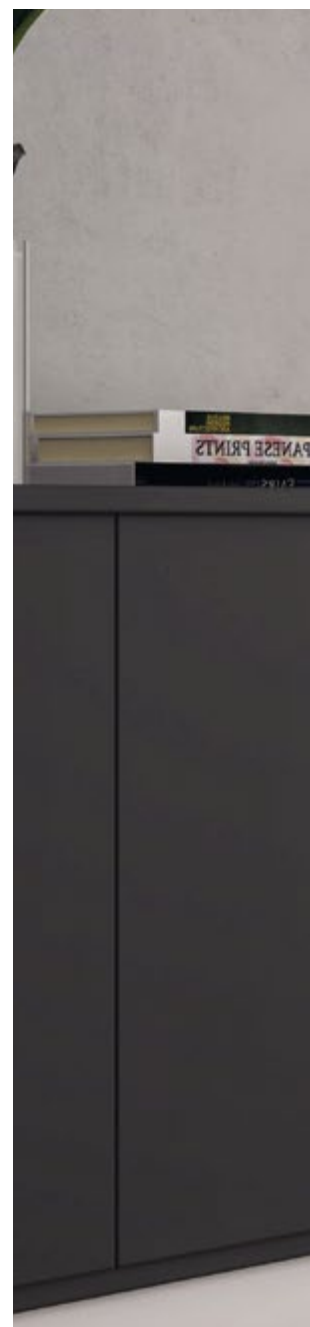
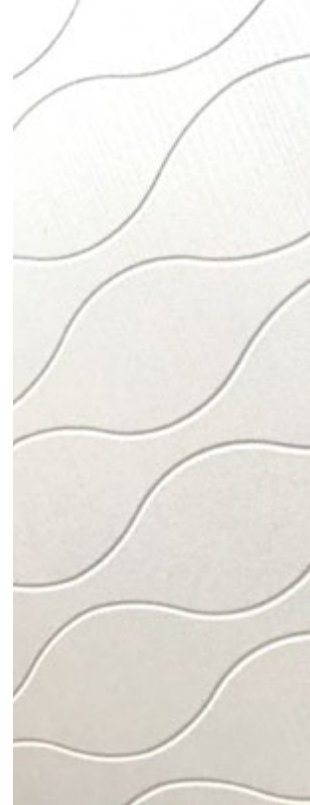

**Visioni Incontro**

Porta scorrevole esterno muro  
 Decoro **V10-Q** sabbiato  
 Vetro satinato extrachiaro  
 Sistema di scorrimento **Cubo Fluid**  
 Maniglione MAN-QS

**Visioni Incontro**

*External wall sliding door*  
*Sandblasted V10-Q decoration*  
*Extra-clear satin glass*  
*Cubo Fluid slider system*  
*MAN-QS pull handle*

Trix **GF40**

**Visioni Incontro**

Porta scorrevole esterno muro  
 Decoro **V17-AF** inciso  
 Vetro satinato grigio  
 Sistema di scorrimento **Luna Soft Close**  
 Maniglia VAS-T

**Visioni Incontro**

*External wall sliding door*  
*Sandblasted V17-AF decoration*  
*Gray satin glass*  
*Luna Soft Close sliding system*  
*VAS-T handle*





# Vetri *Incontro* satinati incisi



V2-H



V2-L



V2-P



V2-T



V2-U



V2-W



V2-Z



V2-FF



V2-Y



V2-F2



V2-F4



V2-F7



V2-FA



V2-FC



V4-C



V17-A



V17-B



V17-C



V17-D



V17-E



V17-F



V17-AB



V17-G



V17-H

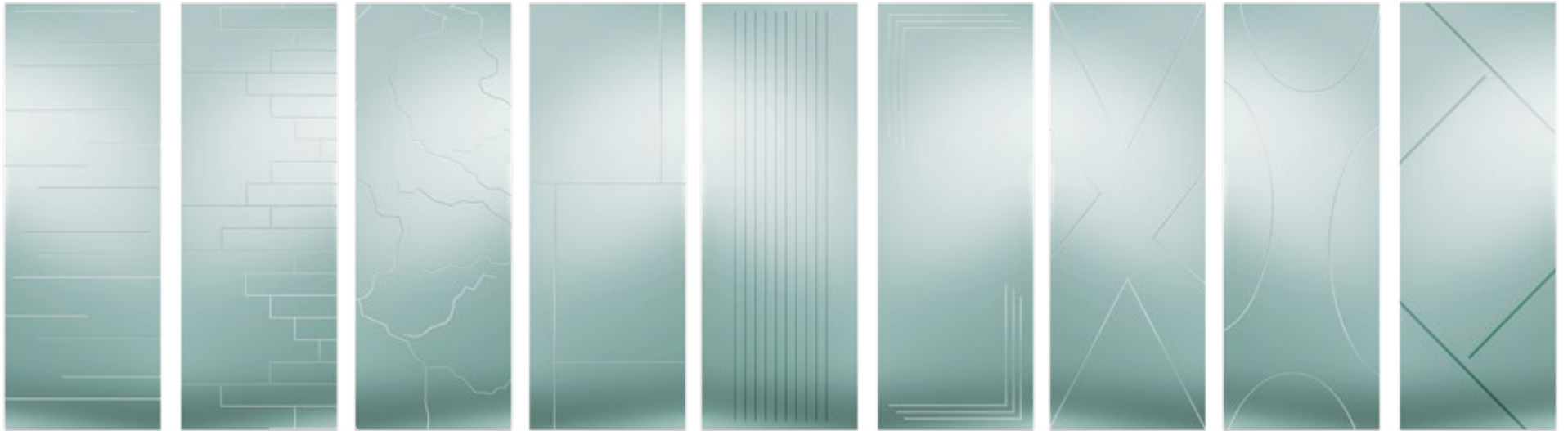

V17-I

V17-L

V17-M

V17-N

V17-J

V17-O

V17-P

V17-Q

V17-R

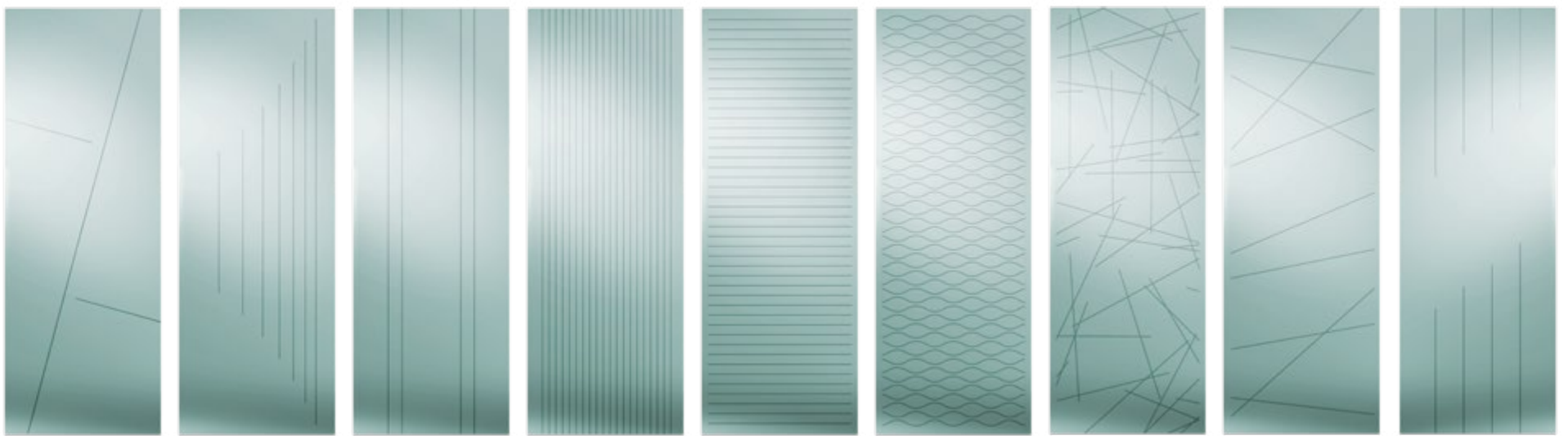

V17-S

V17-AA

V17-X

V17-AD

V17-AE

V17-AF

V17-AG

V17-K

V17-T

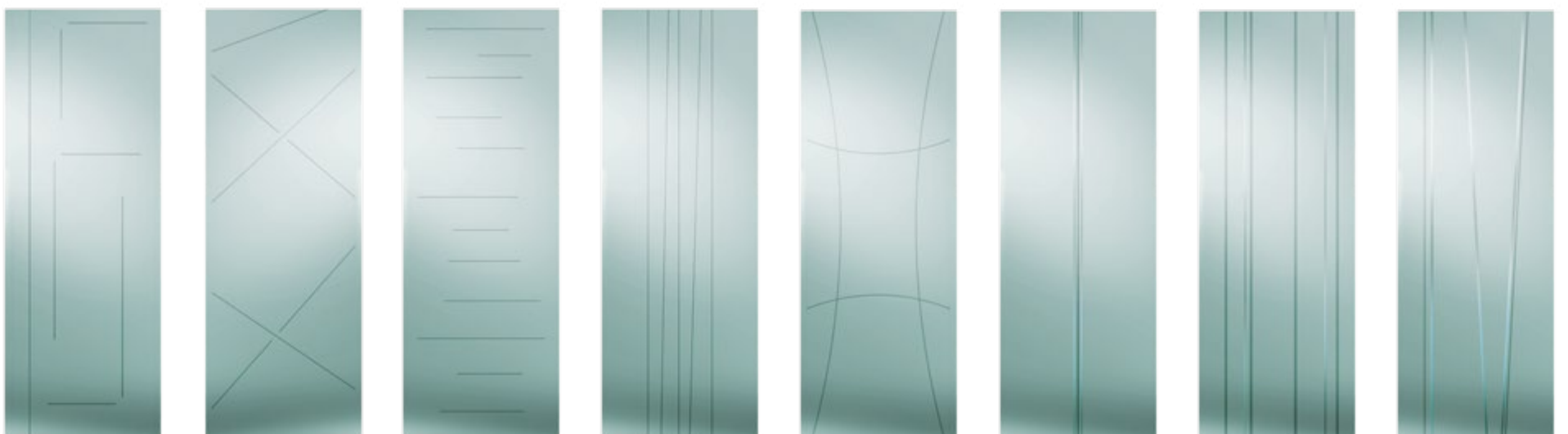

V17-U

V17-V

V17-W

V17-Y

V17-Z

V14-A

V14-B

V14-C



# Vetri *Incontro* satinati sabbatiati



V16-A



V16-G



V16-H



V16-E



V16-P



V16-Q



V16-O



V16-U



V16-J



V16-AO



V16-AP



V10-Q



V10-R



V10-S



V16-K



V16-V



V16-W



V16-X



V16-Y



V16-Z



V16-AA



V16-AB



V16-AC



V16-AD



V16-AE



V16-AF



V16-AG



V16-AH



V16-AI



V16-AL



V16-AM



V16-AN







# IL VETRO NELLA SUA ESSENZA

Esplora l'eleganza senza tempo  
dei nostri vetri: dal vetro satinato  
al vetro trasparente, scopri  
le nostre straordinarie lavorazioni  
per dare vita alla tua visione.

*Explore the timeless elegance of our glass: from  
satin glass to clear glass, discover our extraordinary  
workmanship to bring your vision to life.*



# Neutri

Disponibili su Visioni e Visioni Profile

I nostri vetri si declinano in cinque affascinanti tonalità. Dall'extrachiaro alla profondità del nero, passando per il classico float, il contemporaneo grigio e il creativo bronzo: scopri le sfumature che arricchiranno il tuo design con eleganza e stile.

*Our glass comes in five fascinating shades. From extra-clear to the depth of black, passing through the classic float, the contemporary gray and the creative bronze: discover the shades that will enrich your design with elegance and style.*



**FLOAT TRASPARENTE**



**EXTRACHIARO TRASPARENTE**



**GRIGIO TRASPARENTE**

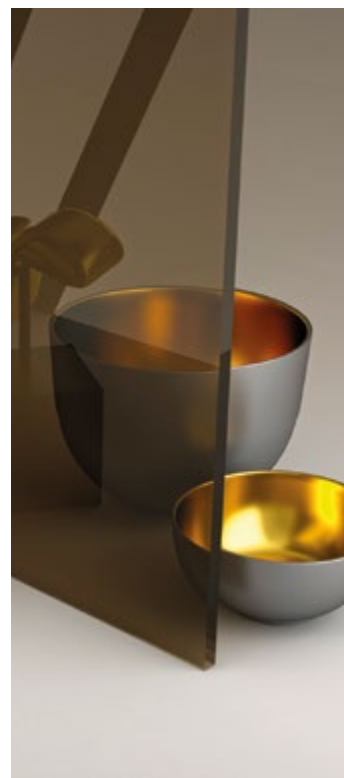

**BRONZO TRASPARENTE**



**DARK TRASPARENTE**  
● non disponibile su Visioni Profile



**FLOAT SATINATO**



**EXTRACHIARO SATINATO**



**GRIGIO SATINATO**

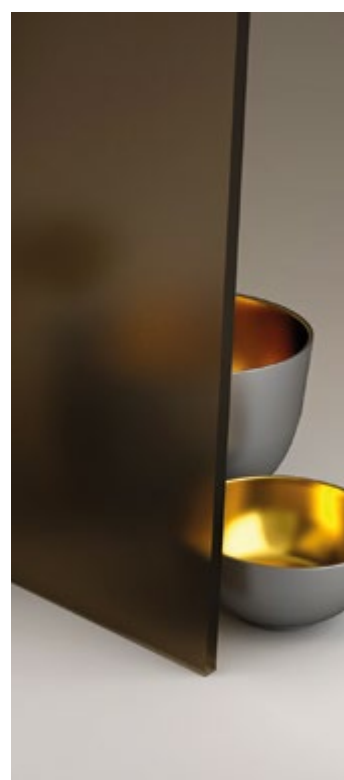

**BRONZO SATINATO**



**DARK SATINATO**  
● non disponibile su Visioni Profile

# Reflex

Disponibili su Visioni e Visioni Profile

Riflessi sofisticati e stile unico. Esplora la nostra selezione di vetri con effetto reflex, che catturano l'essenza della luce, e vetri con effetto specchio, per un tocco di glamour senza pari. Vetro non trasparente, caratterizzato da effetto riflettente e con effetto metallizzato superficiale. La riflessione della superficie aumenta al diminuire della luminosità dell'ambiente.

*Sophisticated reflections and unique style. Explore our selection of glass with a reflex effect, which captures the essence of light, and glass with a mirror effect, for an unparalleled touch of glamour. Non-transparent glass, characterized by a reflective effect and a metallic surface effect. Surface reflection increases as the ambient brightness decreases.*



**REFLEX** TRASPARENTE BIANCO

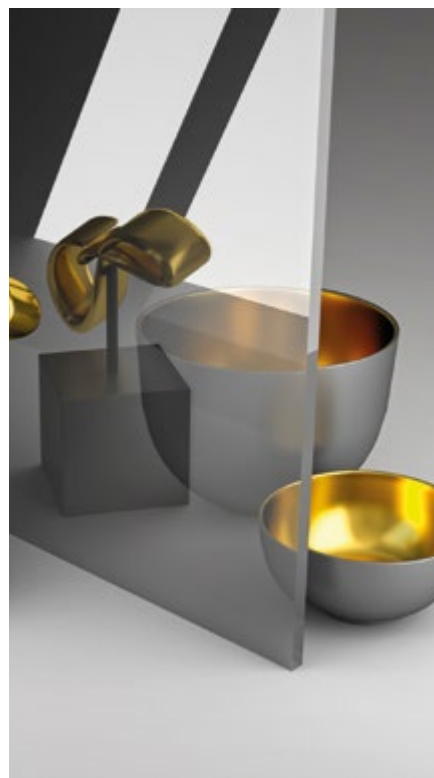

**REFLEX** TRASPARENTE GRIGIO

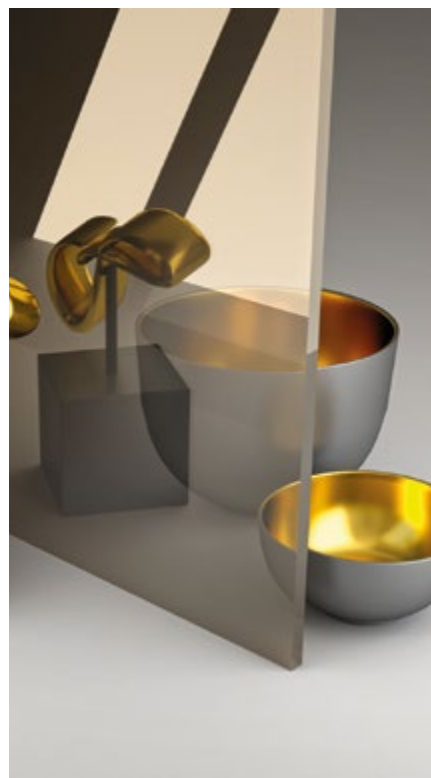

**REFLEX** TRASPARENTE BRONZO



**REFLEX** SATINATO BIANCO



**REFLEX** SATINATO GRIGIO



**REFLEX** SATINATO BRONZO



**EFFETTO SPECCHIO**



# Hays

Disponibili su Visioni e Visioni Profile

Vetro trasparente con una leggera texture in rilievo. Il disegno è delicato e appena percettibile, per una porta delicata di altro livello estetico. Grande facilità di pulizia.

*Transparent glass with a light raised texture. The design is delicate and barely perceptible, for a delicate door of a high aesthetic level. Great ease of cleaning.*



HAYS EXTRACHIARO

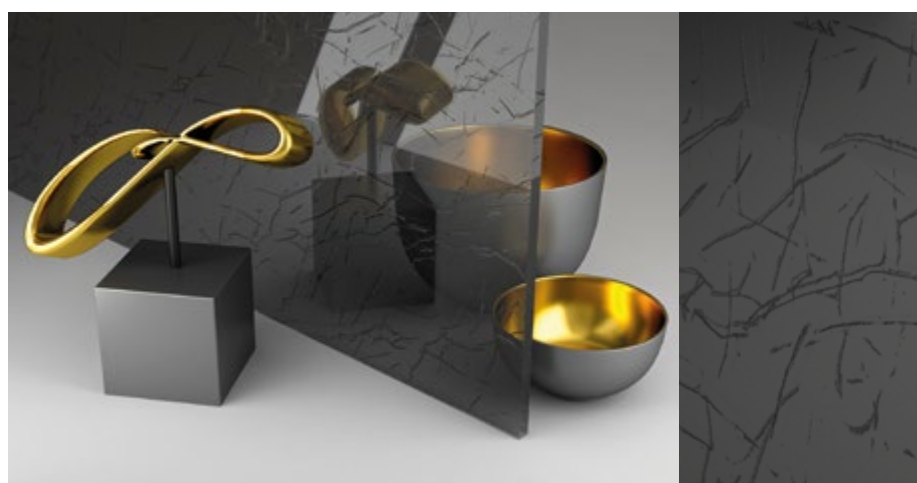

HAYS GRIGIO



HAYS BRONZO

# Kamyl

Disponibili su Visioni e Visioni Profile

È caratterizzato per la delicata texture, linee fitte ed irregolari disegnano una fine ragnatela sulla superficie della lastra. La superficie è perfettamente liscia al tatto, ed è disponibile con vetro extrachiaro, grigio e bronzo.

*It is characterized by its delicate texture, thick and irregular lines draw a fine spider web on the surface of the slab. The surface is perfectly smooth to the touch, and is available with extra-clear, gray and bronze glass.*

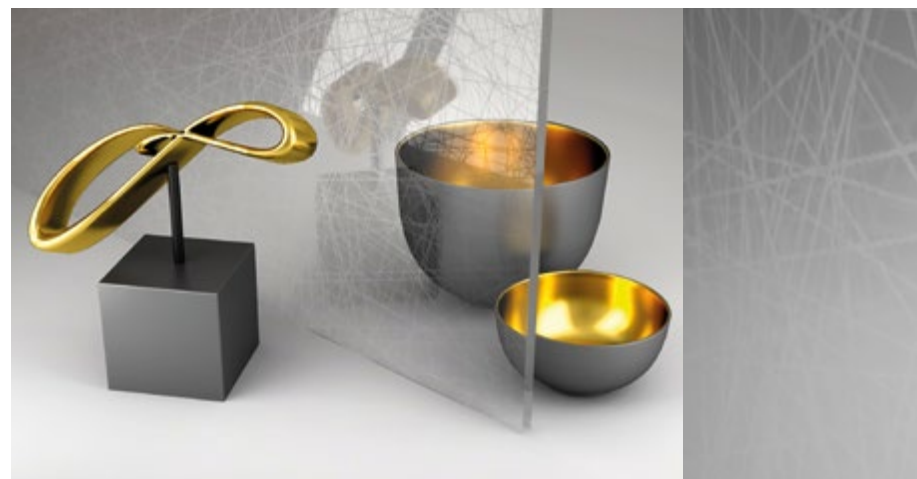

KAMYL EXTRACHIARO

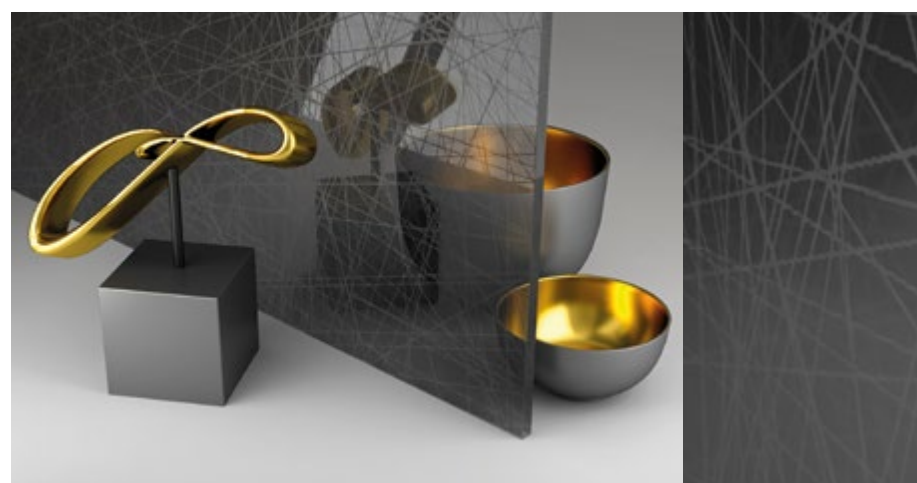

KAMYL GRIGIO



KAMYL BRONZO

# Kostel

Disponibili su Visioni e Visioni Profile

Tanti piccoli puntini regolari presenti sulla superficie del vetro come una costellazione, rendono questo vetro elegante e raffinato. La superficie è liscia e l'incavo dei piccoli punti è appena percettibile per assicurare una facile e immediata pulizia. Disponibile con base vetro extrachiaro, grigio e bronzo.

*Many small regular dots present on the surface of the glass like a constellation, make this glass elegant and refined. The surface is smooth and the indentation of the small dots is barely perceptible to ensure easy and immediate cleaning. Available with extra-clear, gray and bronze glass base.*

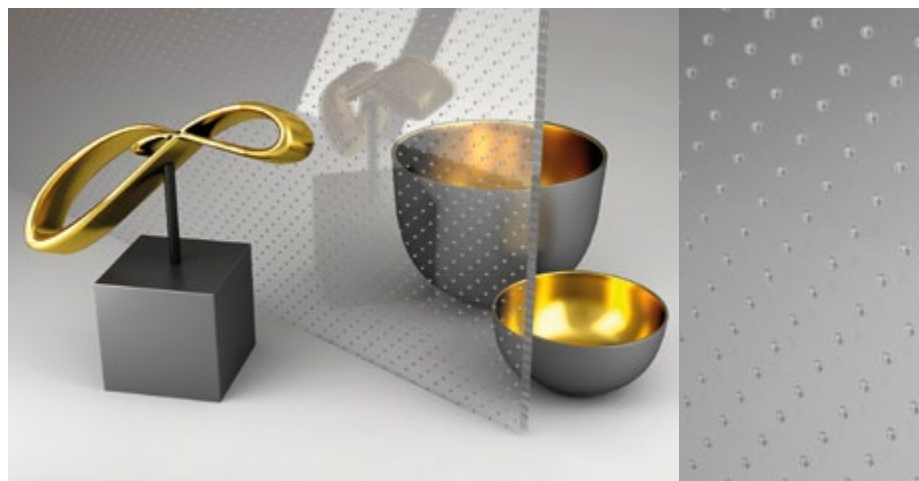

KOSTEL EXTRACHIARO

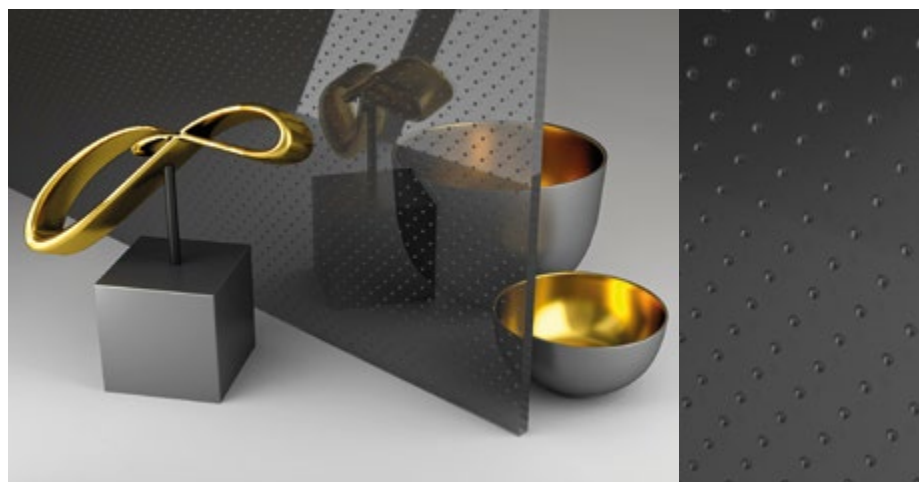

KOSTEL GRIGIO

KOSTEL GRIGIO

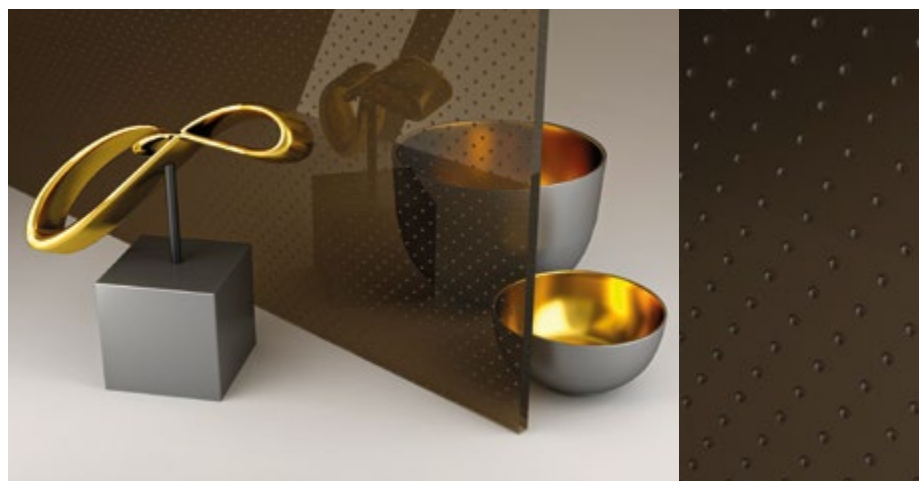

KOSTEL BRONZO

# Stowe

Disponibili su Visioni e Visioni Profile

La texture, ha una finitura satinata opaca a bassissimo rilievo su fondo satinato. Un vetro unico, adatto per chi vuole discrezione senza rinunciare alla luce, ottimo alla resistenza alle impronte e soprattutto facile da pulire.

*The texture has a matte satin finish with very low relief on a satin background. A unique glass, suitable for those who want discretion without sacrificing light, excellent resistance to fingerprints and above all easy to clean.*

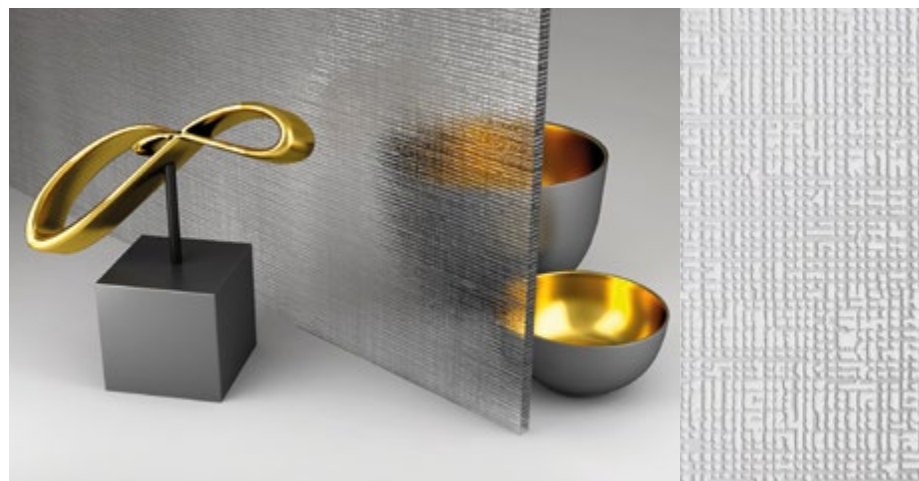

STOWE EXTRACHIARO

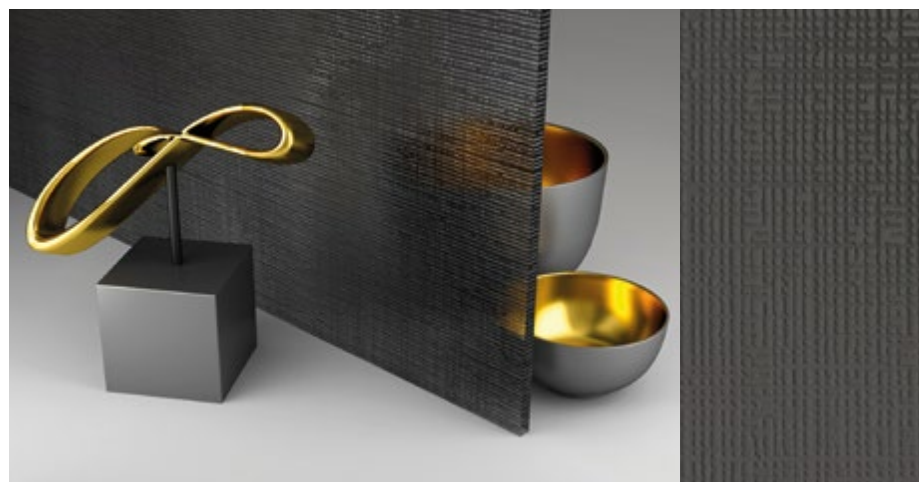

STOWE GRIGIO

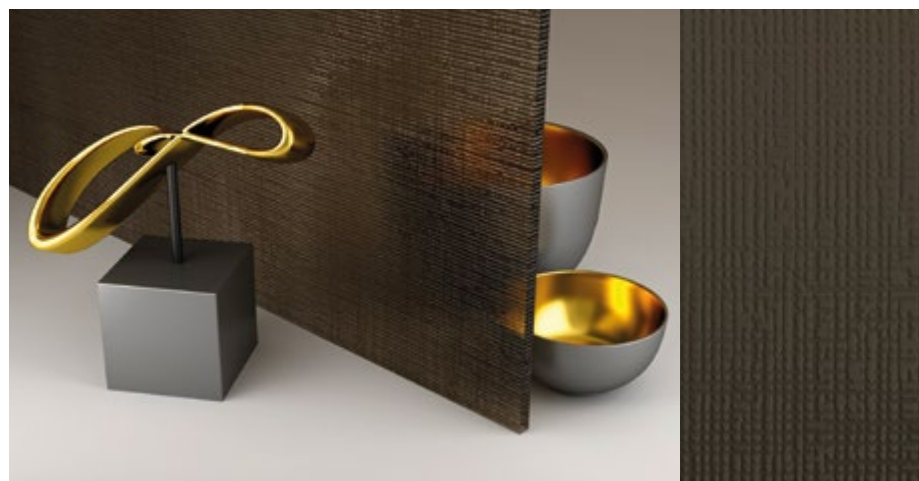

STOWE BRONZO



# Connection

Disponibili su Visioni e Visioni Profile

La serie di vetri "Connection" ha un cuore d'acciaio. Tre reti metalliche con trame differenti, accoppiate ad un vetro extrachiaro, grigio o bronzo, conferiscono alla porta un tocco personale dal design moderno e delicato.

*The "Connection" glass series has a heart of steel. Three metal meshes with different textures, coupled with extra-clear, gray or bronze glass, give the door a personal touch with a modern and delicate design.*

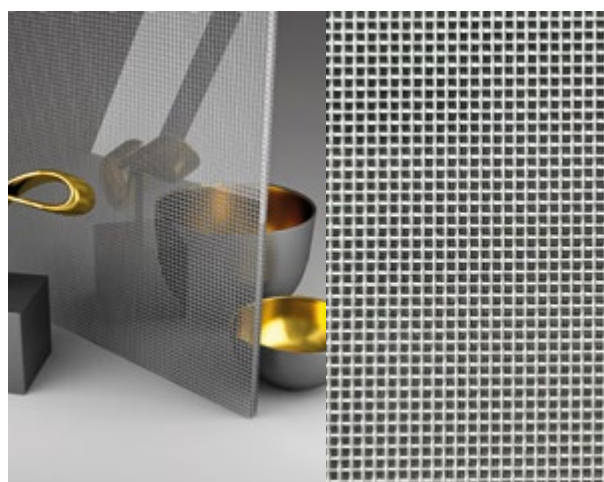

**WIDE Connection** EXTRACHIARO

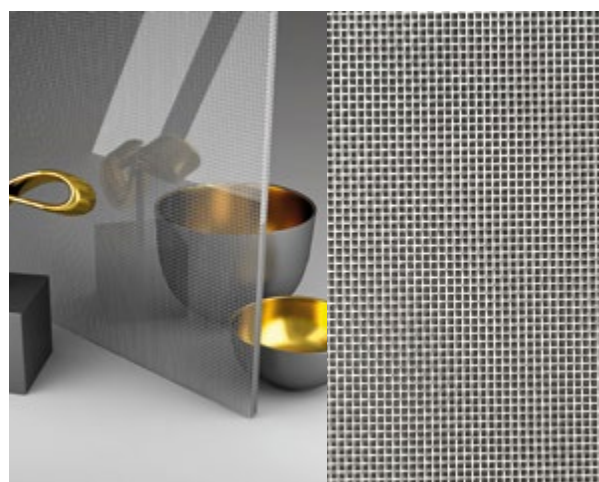

**MEDIUM Connection** EXTRACHIARO

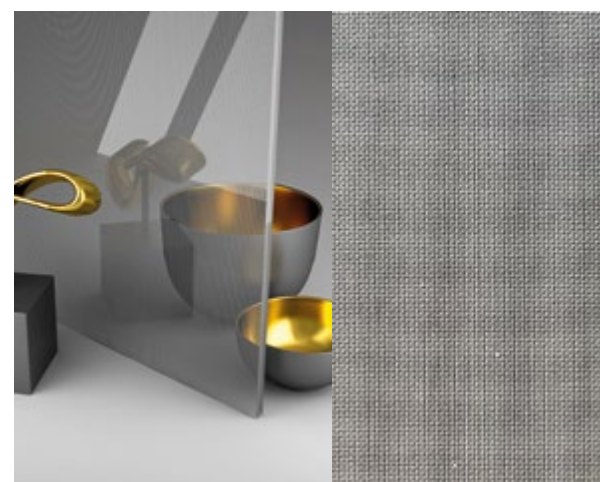

**LITE Connection** EXTRACHIARO

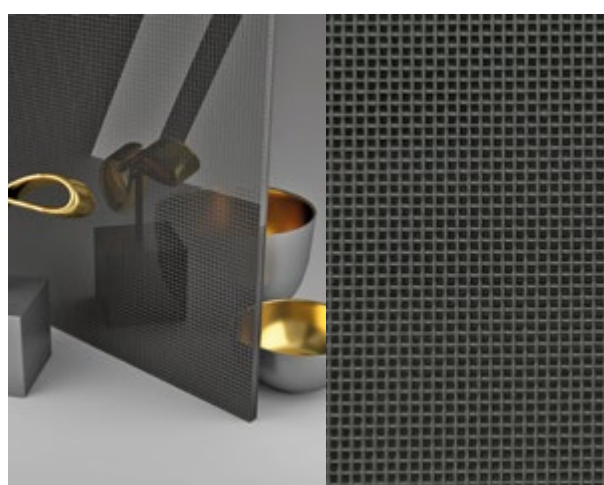

**WIDE Connection** GRIGIO

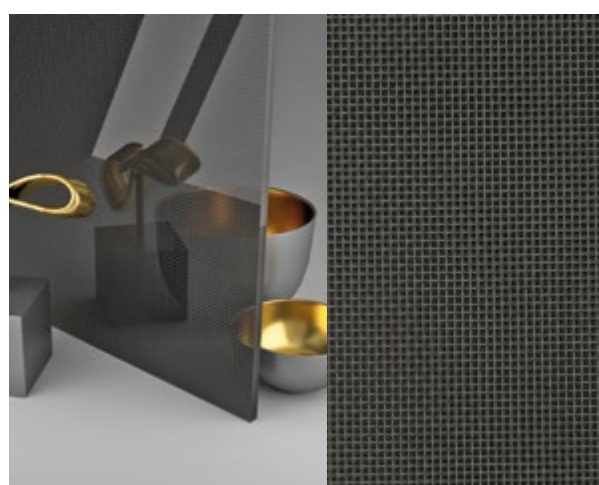

**MEDIUM Connection** GRIGIO

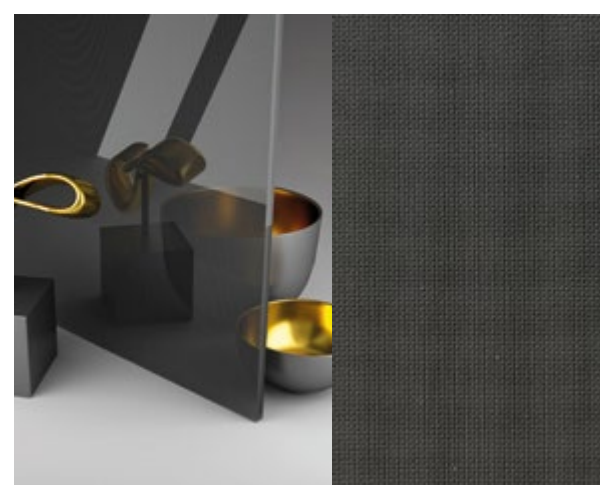

**LITE Connection** GRIGIO

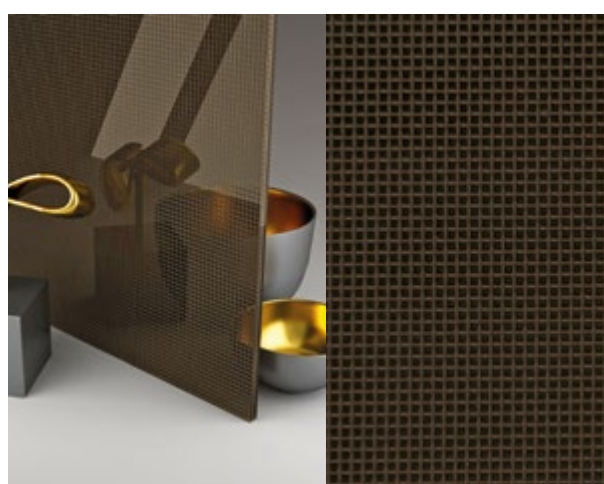

**WIDE Connection** BRONZO

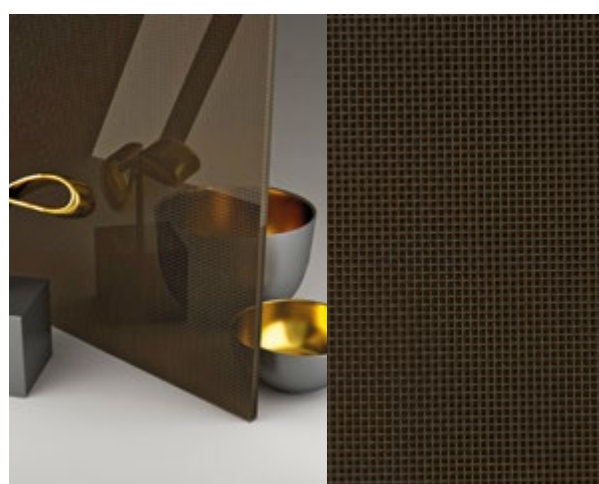

**MEDIUM Connection** BRONZO

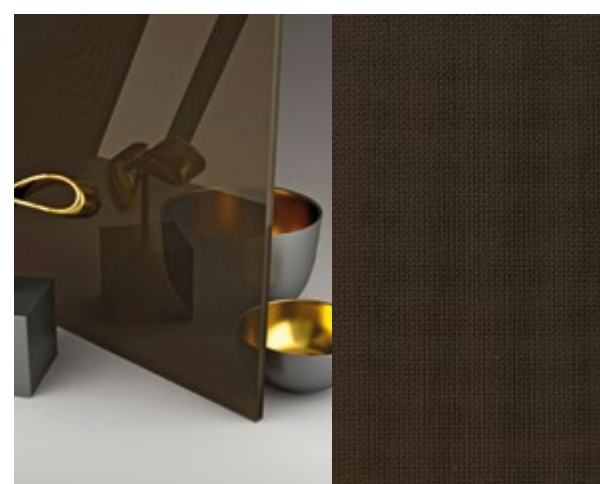

**LITE Connection** BRONZO



# Canvas

Disponibili su Visioni e Visioni Profile

La stoffa all'interno del vetro, per personalizzare le proprie porte con un design unico ed originale. Cinque trame e colori differenti, abbinata ad un vetro extrachiaro, capace di adattarsi ad un design ricercato ed unico.

*The fabric inside the glass, to personalize your doors with a unique and original design. Five different textures and colours, combined with extra-clear glass, capable of adapting to a refined and unique design.*

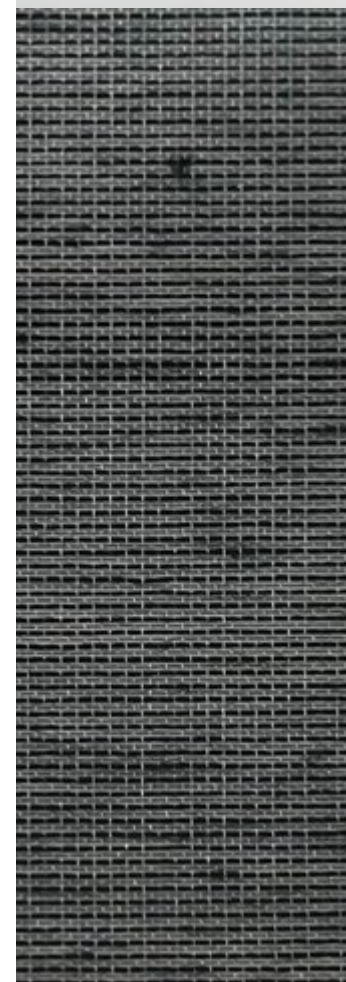
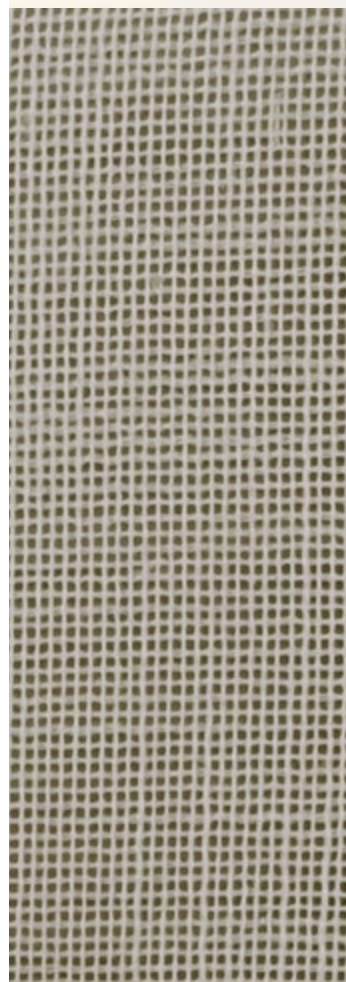
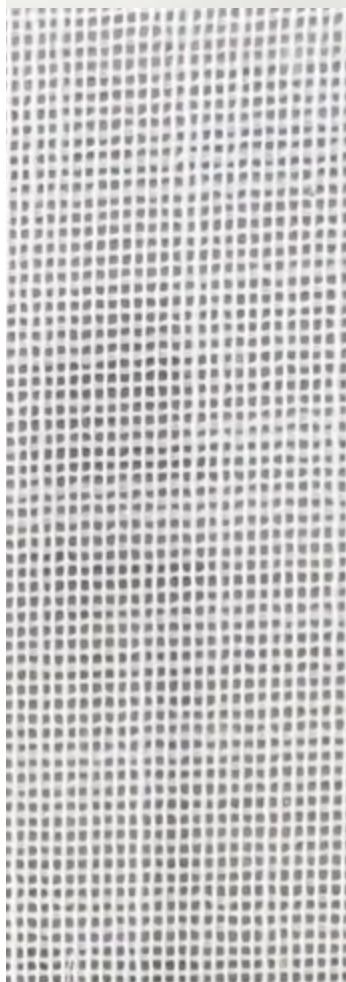
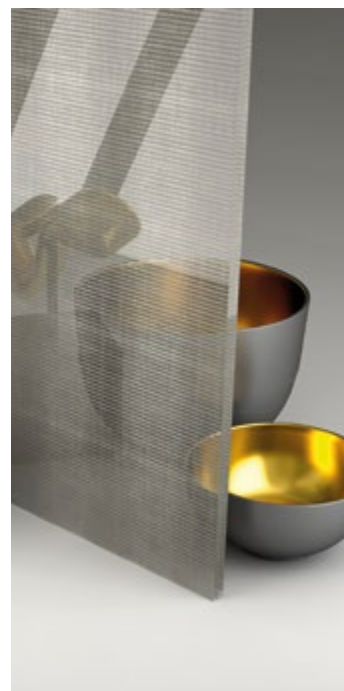
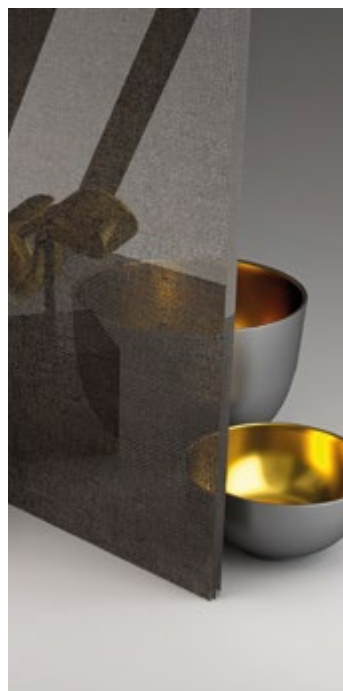
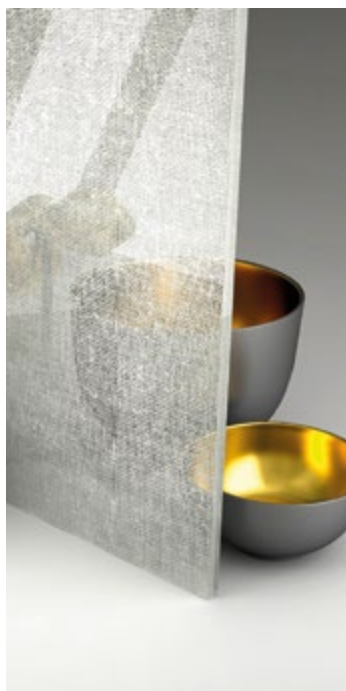

**CREAM Canvas** EXTRACHIARO

**DESERT Canvas** EXTRACHIARO

**CHOCOLATE Canvas** EXTRACHIARO

**LIJNEN Canvas** EXTRACHIARO

**DARK Canvas** EXTRACHIARO



# AT

Vetro SATINATO da 10 mm e disegno trasparente  
Vetro SATINATO da 10 mm e disegno trasparente

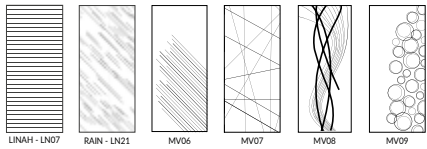

Lavorazione AT EXTRACHIARO

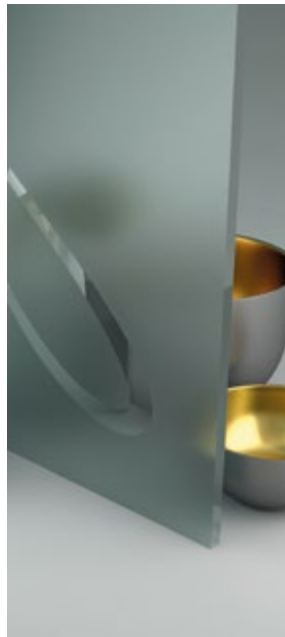

Lavorazione AT FLOAT

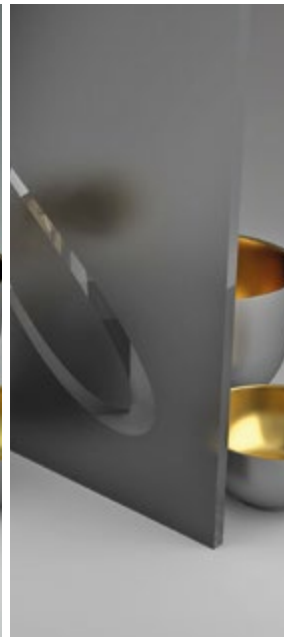

Lavorazione AT GRIGIO



Lavorazione AT BRONZO

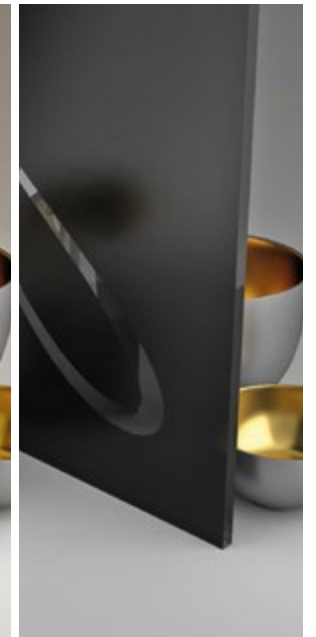

Lavorazione AT DARK

# ST

Vetro SABBBIATO da 10 mm con disegno trasparente  
Vetro SABBBIATO da 10 mm con disegno trasparente

Disponibile anche in Satcolor ceramico / Also available in ceramic Satcolor

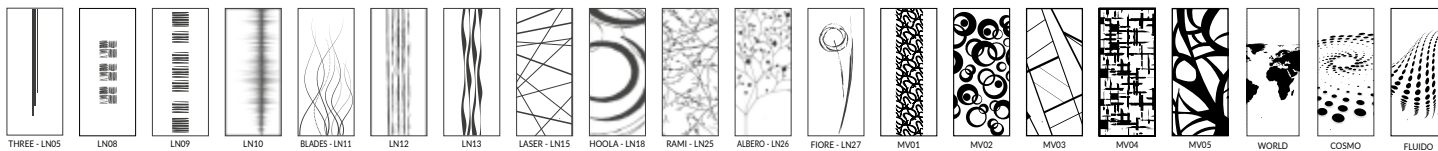

Lavorazione ST EXTRACHIARO



Lavorazione ST FLOAT



Lavorazione ST GRIGIO



Lavorazione ST BRONZO

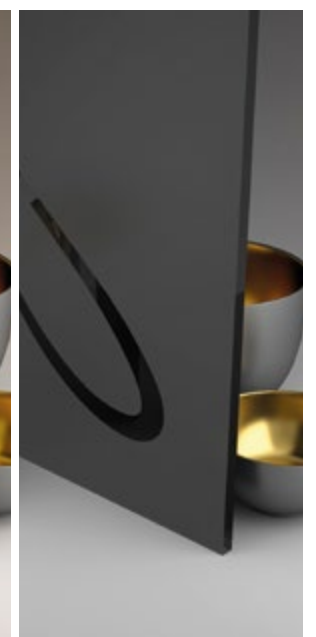

Lavorazione ST DARK

## AS

vetro SATINATO da 10 mm con disegno SABBBIATO e scavato su di un lato  
 vetro satinato da 10 mm con disegno SABBBIATO e scavato su di un lato

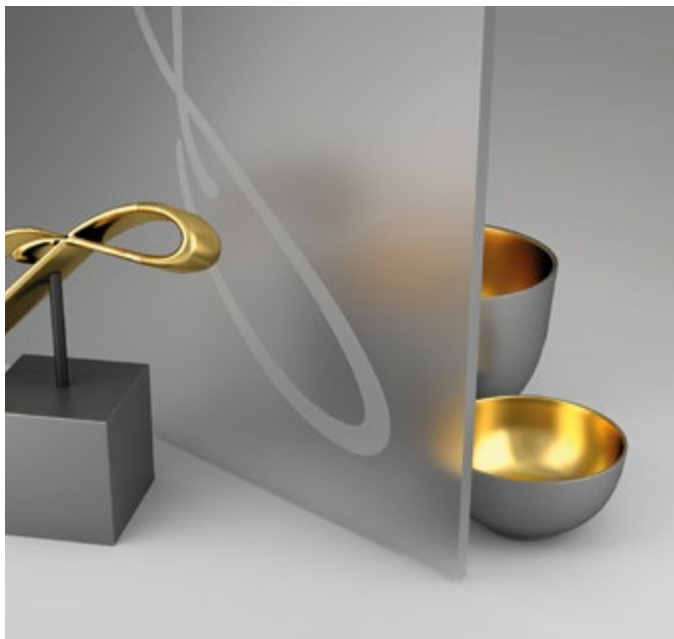
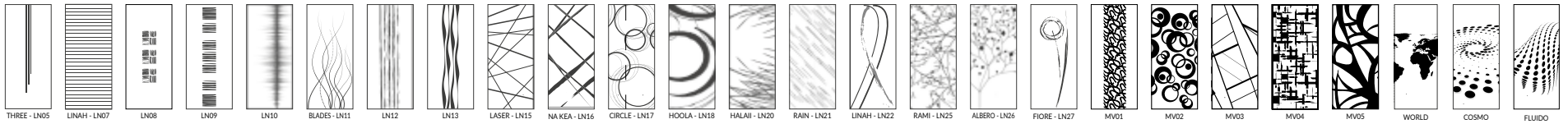

Lavorazione AD EXTRACHIARO



Lavorazione AD FLOAT

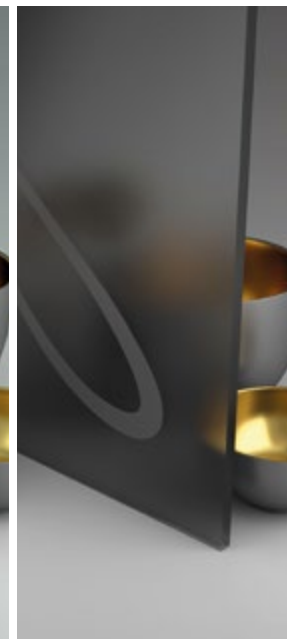

Lavorazione AD GRIGIO



Lavorazione AD BRONZO

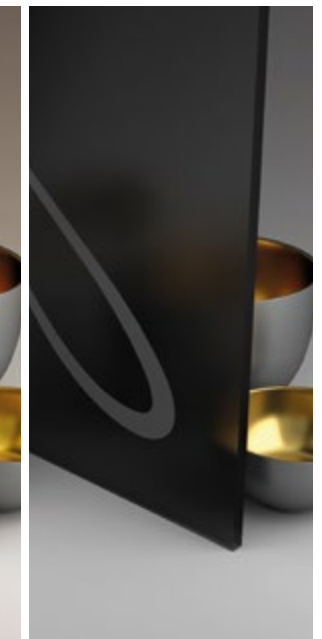

Lavorazione AD DARK

## TS

Vetro TRASPARENTE da 10 mm con disegno SABBBIATO su di un lato  
 Vetro TRASPARENTE da 10 mm con disegno SABBBIATO su di un lato

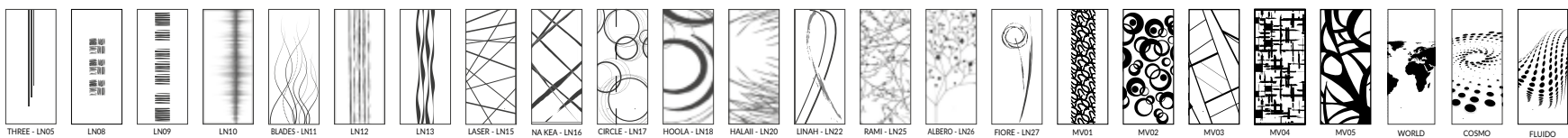

Lavorazione TS EXTRACHIARO



Lavorazione TS FLOAT

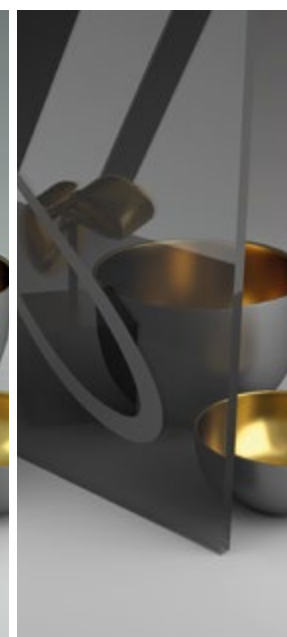

Lavorazione TS GRIGIO



Lavorazione TS BRONZO

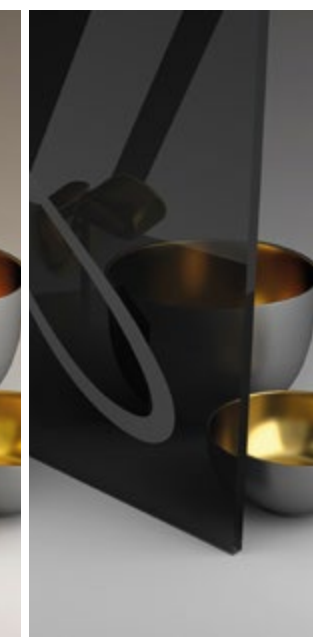

Lavorazione TS DARK



# STS

vetro SABBATO da 10 mm con disegno trasparente e sabbiato  
vetro SABBATO da 10 mm con disegno trasparente e sabbiato

Disponibile anche nella versione Glass Chrome / Also available in the Glass Chrome version

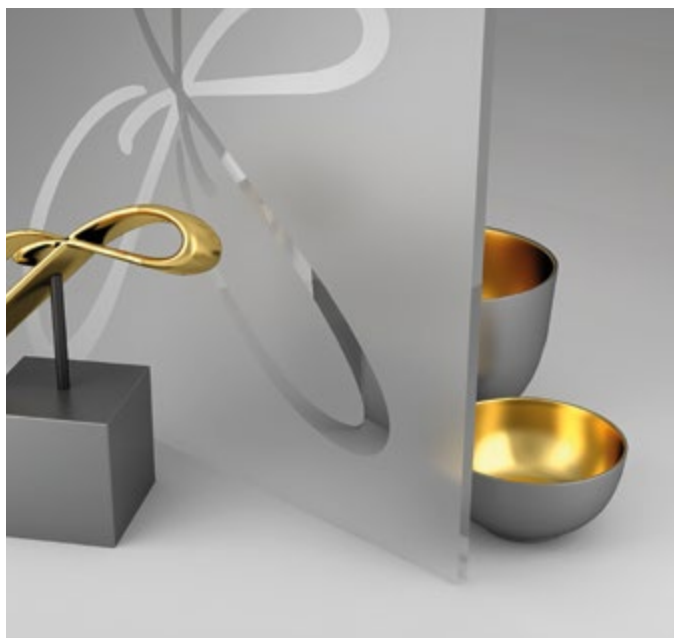
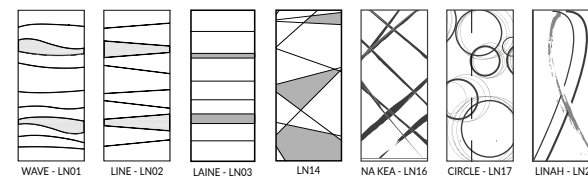

Lavorazione STS EXTRACHIARO



Lavorazione STS FLOAT

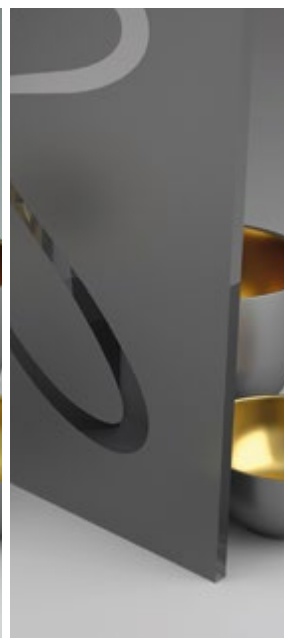

Lavorazione STS GRIGIO

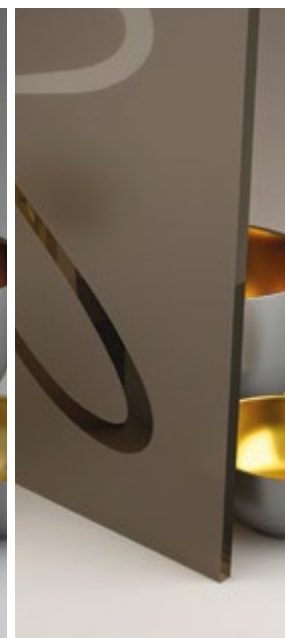

Lavorazione STS BRONZO

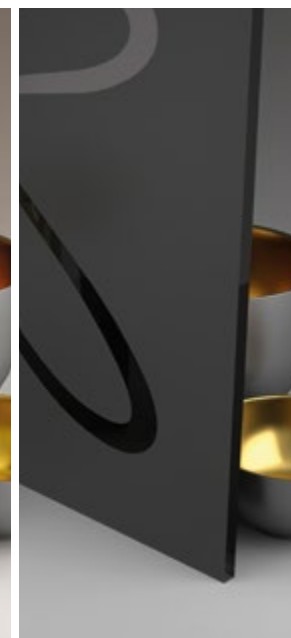

Lavorazione STS DARK

# TI

Vetro trasparente da 10 mm con incisioni opache  
5+5 mm coupled glossy lacquered glass with opaque engravings

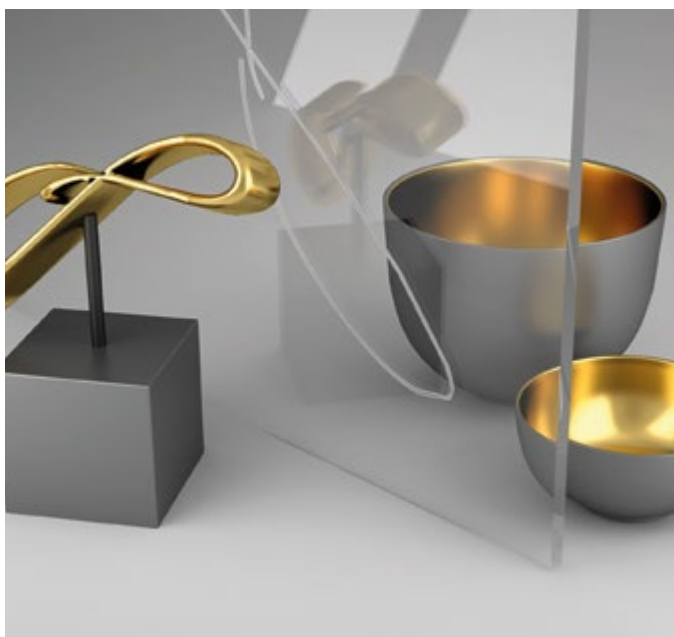
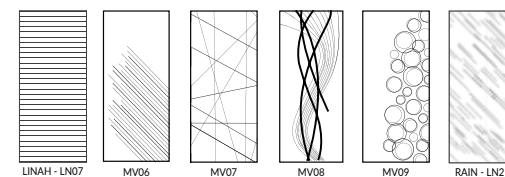

Lavorazione STS FLOAT



Lavorazione STS GRIGIO



Lavorazione STS BRONZO



Lavorazione STS DARK

## MN

Disegno NEGATIVO a specchio effetto 3D  
 NEGATIVE drawing mirrored 3D effect

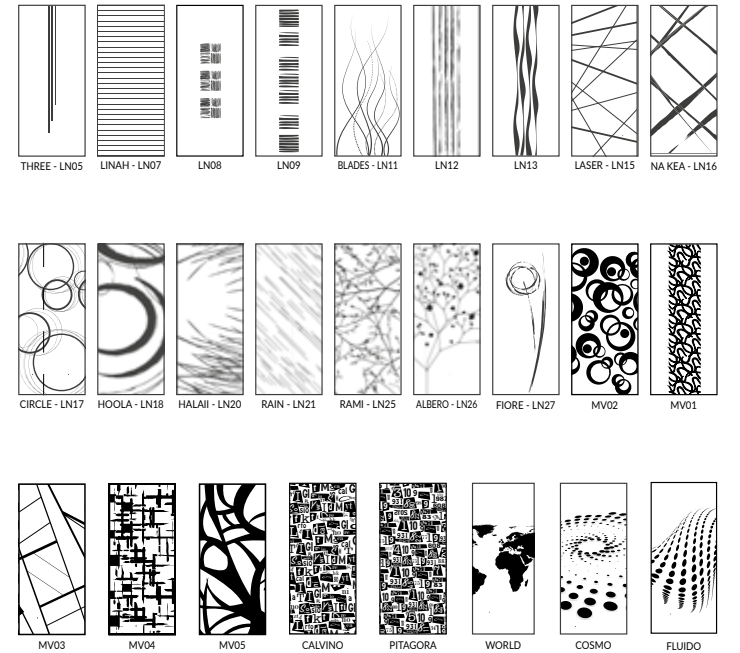
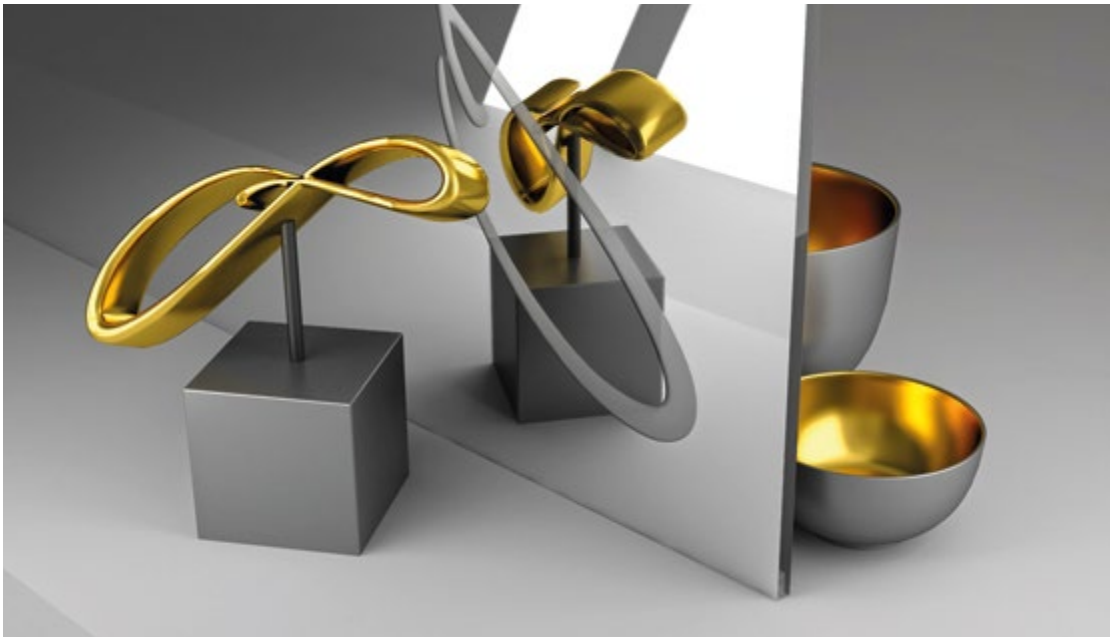

## MP

Disegno POSITIVO a specchio effetto 3D  
 POSITIVE design mirrored 3D effect

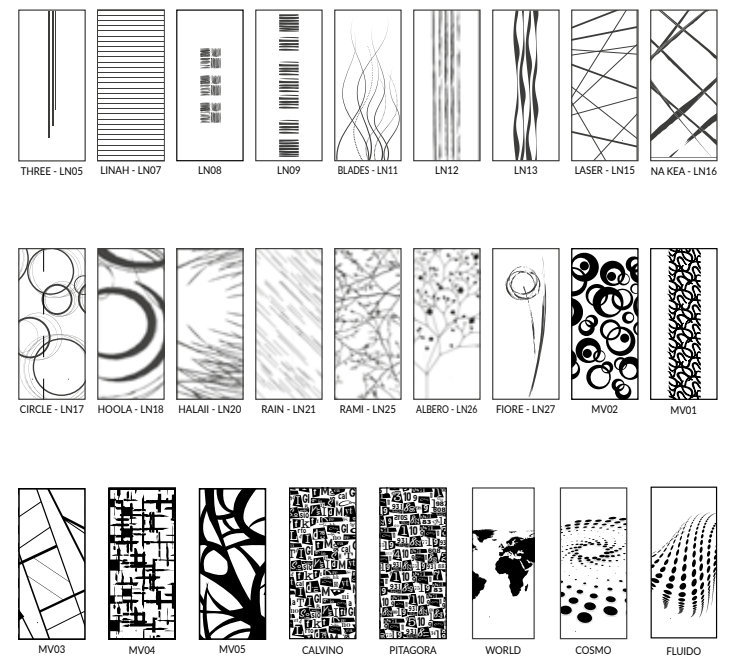



# AD

Vetro satinato con disegno colorato SATCOLOR su lato esterno sp. 10 mm o colorato interno accoppiato 5+5  
*Vetro satinato con disegno colorato SATCOLOR su lato esterno sp. 10 mm o colorato interno accoppiato 5+5*

Vedi colori disponibili a pag. 198 

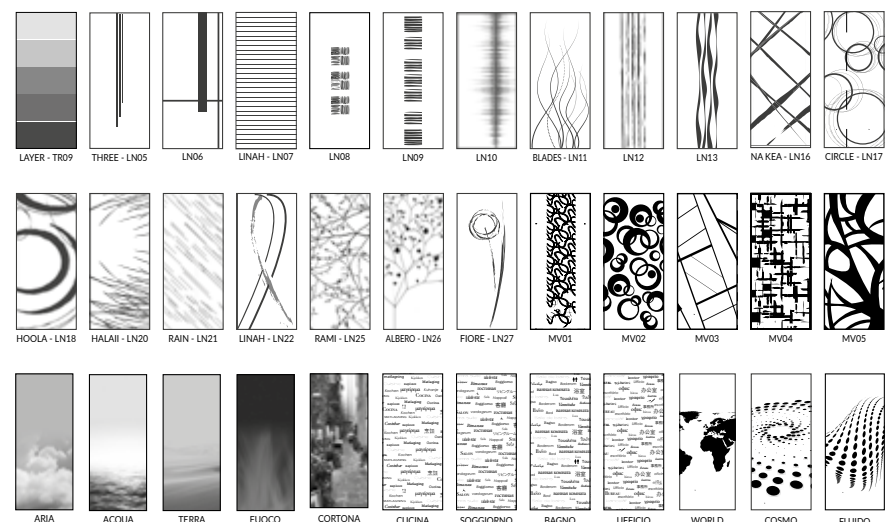
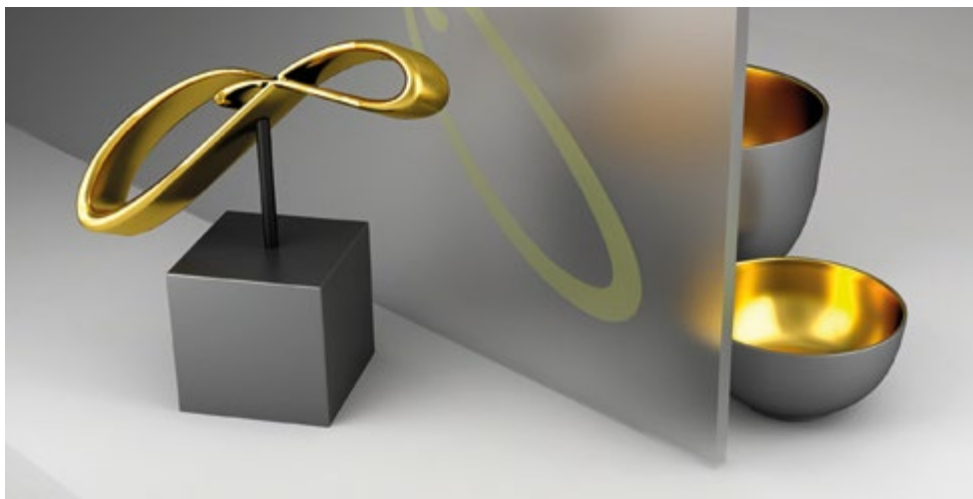

# TD

Vetro accoppiato 5+5 mm trasparente con disegno SATCOLOR all'interno  
*Vetro accoppiato 5+5 mm trasparente con disegno SATCOLOR all'interno*

Vedi colori disponibili a pag. 198 

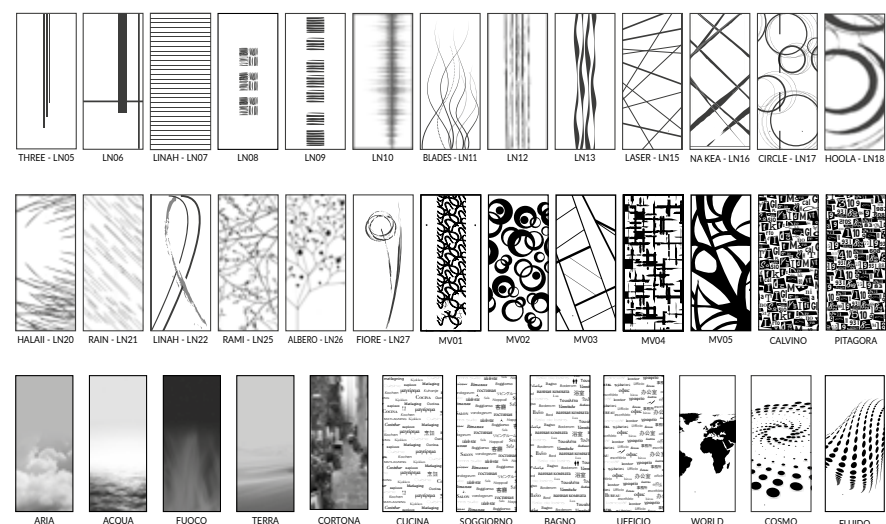
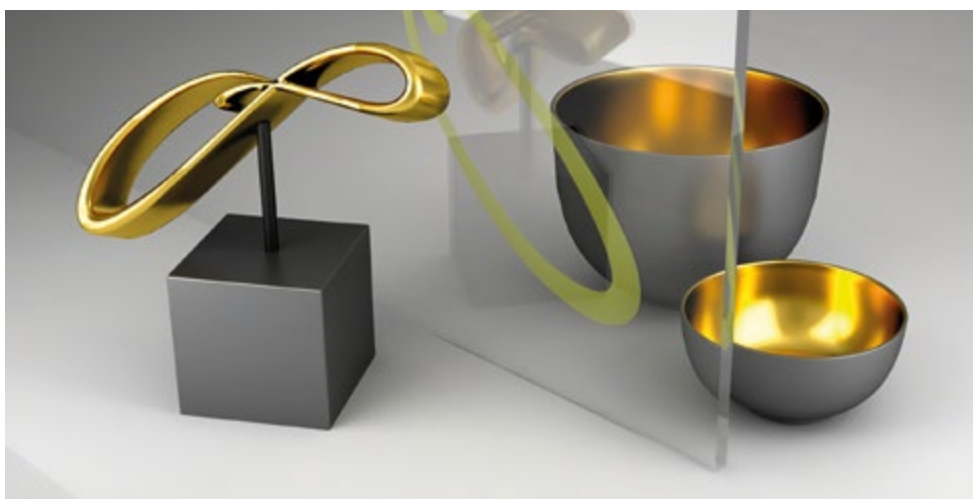

# LB

Vetro Laccato Lucido accoppiato 5+5 mm con disegno SABBIAITO esterno su entrambi i lati  
*5+5 mm coupled glossy lacquered glass with external SANDBLAST design on both sides*

Vedi colori disponibili a pag. 196 

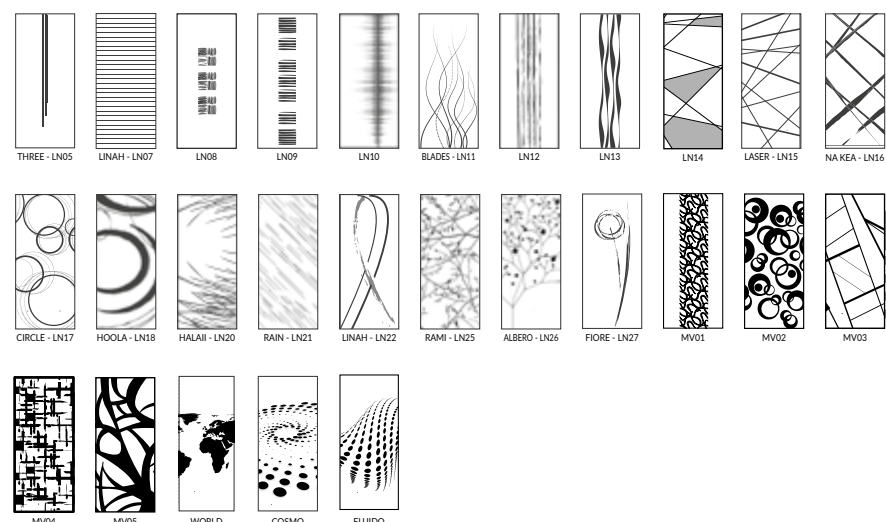











# Lavorazioni

MODELLO		BASE VETRO				
	cod.	FLOAT (FL)	EXTRACHIARO (EX)	GRIGIO (GR)	BRONZO (BR)	DARK (DK)
VETRO TRASPARENTE	<b>TR01</b>	●	●	●	●	●
VETRO SATINATO	<b>TR02</b>	●	●	●	●	●
VETRO LACCATO LUCIDO	<b>TR03</b>		●			
VETRO LACCATO SATINATO	<b>TR04</b>		●			
VETRO SATCOLOR	<b>TR05</b>		●			
VETRO REFLEX SATINATO	<b>TR06</b>		●	●	●	
VETRO REFLEX TRASPARENTE	<b>TR06/T</b>		●	●	●	
EFFETTO SPECCHIO	<b>TR07</b>					
VETRO SATCOLOR SFUMATO	<b>TR08</b>		●			
VETRO SATCOLOR GRADAZIONI	<b>TR09</b>		●			
VETRO NEUTRAL	<b>TR10</b>	●	●	●	●	
VETRO SETA	<b>TR11</b>	●	●	●	●	
<b>INCONTRO</b>		<b>FL</b>	<b>EX</b>	<b>GR</b>	<b>BR</b>	<b>DK</b>
VETRO INCISO	<b>V2 - V4 V14 - V17</b>	●	●	●	●	
VETRO SABBIAATO	<b>V10 - V16</b>	●	●	●	●	





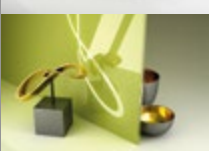





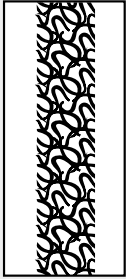

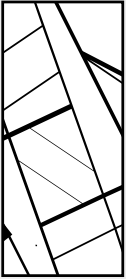
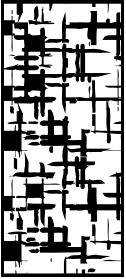

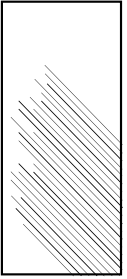
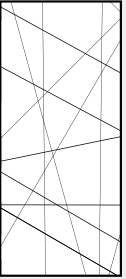
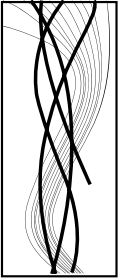
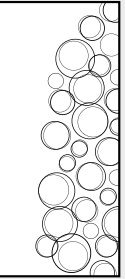

BASI VETRO	LAVORAZIONI										
	AS	AT	ST	STS	TS	TI	MN	MP	AD	TD	LB
<b>FLOAT</b>	●	●	●	●	●	●					
<b>EXTRACHIARO</b>	●	●	●	●	●	●			●	●	●
<b>GRIGIO</b>	●	●	●	●	●	●					
<b>BRONZO</b>	●	●	●	●	●	●					
<b>DARK</b>	●	●	●	●	●	●					



		LAYER - TR09	WAVE - LN01	LINE - LN02	LAINE - LN03	THREE - LN05	LN06	LINAH - LN07	LN08	LN09	LN10	BLADES - LN11
	<b>AT</b>							●				
	<b>ST</b>					●			●	●	●	●
	<b>AS</b>					●		●	●	●	●	●
	<b>TS</b>					●			●	●	●	●
	<b>STS</b>		●	●	●							
	<b>TI</b>							●				
	<b>MN</b>					●		●	●	●		●
	<b>MP</b>					●		●	●	●		●
	<b>AD</b>	●				●	●	●	●	●	●	●
	<b>TD</b>					●	●	●	●	●	●	●
	<b>LB</b>					●		●	●	●	●	●

LN12	LN13	LN14	LASER - LN15	NA KEA - LN16	CIRCLE - LN17	HOOLA - LN18	HALAII - LN20	RAIN - LN21	LINAH - LN22	RAMI - LN25	ALBERO - LN26	FIORE - LN27
								●				
●	●		●			●				●	●	●
●	●		●	●	●	●	●	●	●	●	●	●
●	●		●	●	●	●	●		●	●	●	●
		●		●	●				●			
								●				
●	●		●	●	●	●	●	●		●	●	●
●	●		●	●	●	●	●	●		●	●	●
●	●		●	●	●	●	●	●	●	●	●	●
●	●		●	●	●	●	●	●	●	●	●	●
●	●	●	●	●	●	●	●	●	●	●	●	●



		 MV01	 MV02	 MV03	 MV04	 MV05	 MV06	 MV07	 MV08	 MV09	 ARIA TM01-A
	<b>AT</b>						●	●	●	●	
	<b>ST</b>	●	●	●	●	●					
	<b>AS</b>	●	●	●	●	●					
	<b>TS</b>	●	●	●	●	●					
	<b>STS</b>										
	<b>TI</b>						●	●	●	●	
	<b>MN</b>	●	●	●	●	●					
	<b>MP</b>	●	●	●	●	●					
	<b>AD</b>	●	●	●	●	●					●
	<b>TD</b>	●	●	●	●	●					●
	<b>LB</b>	●	●	●	●	●					





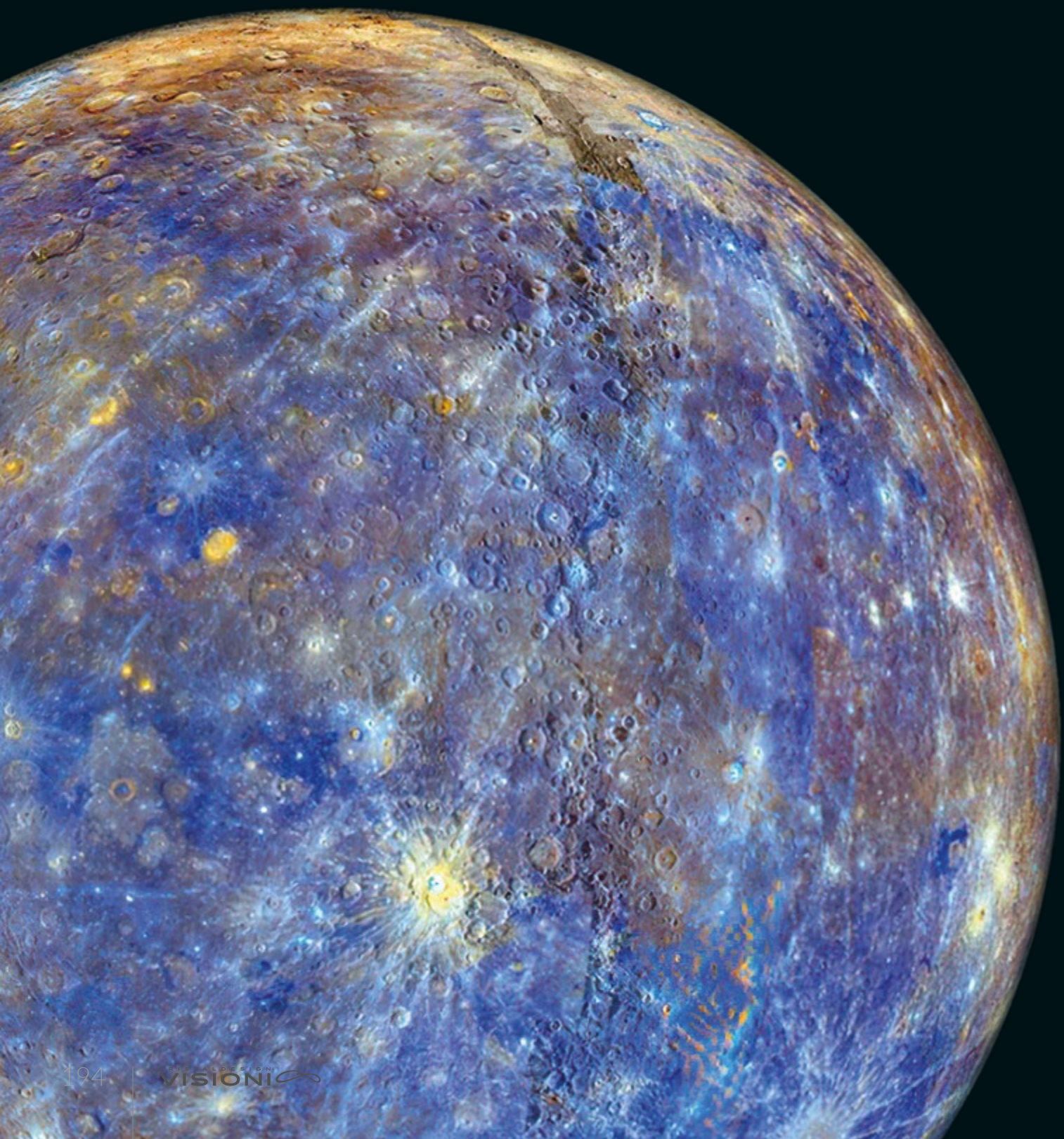

# COLORI E PROFILI

La Poesia dei Colori.

Scopri come il vetro ed i profili in alluminio possono trasformare l'ordinario in straordinario. Scegli tra una vasta gamma di colori per definire il tuo stile.

*The Poetry of Colors. Discover how glass and aluminum profiles can transform the ordinary into the extraordinary. Choose from a wide range of colors to define your style.*



# Laccati lucidi

La laccatura del vetro viene eseguita sulla superficie interna di 2 lastre di vetro temprato dello spessore di 5 mm, successivamente vengono accoppiate, garantendo l'inalterabilità dei colori nel tempo. La lavorazione viene eseguita esclusivamente su vetri extrachiari per non alterare il colore e rendere la massima brillantezza superficiale (100 gloss).

*The glass lacquering is carried out on the internal surface of 2 sheets of tempered glass with a thickness of 5 mm, which are then coupled, guaranteeing the unalterability of the colors over time. The processing is carried out exclusively on extra-clear glass so as not to alter the color and provide maximum surface shine (100 gloss).*



LACCATO lucido BIANCO



LACCATO lucido PERLA



LACCATO lucido ANTRACITE



LACCATO lucido NERO



LACCATO lucido TORTORA



LACCATO lucido SALVIA



LACCATO lucido TERRA



LACCATO lucido MELOGRANO



LACCATO lucido CIELO



LACCATO lucido LIME



LACCATO lucido PORPORA



LACCATO lucido MALVA

# Laccati satinati

Come per la laccatura lucida, anche per il satinato viene eseguita sulla superficie interna di 2 lastre di vetro temprato e satinato dello spessore di 5 mm. Successivamente vengono accoppiate, lasciando il lato satinato delle due lastre all'esterno. La lavorazione viene eseguita esclusivamente su vetri extrachiarissimi per non alterare il colore, al tatto risulterà una superficie vellutata.

*As for glossy lacquering, also for satin lacquering it is carried out on the internal surface of 2 sheets of tempered and satin glass with a thickness of 5 mm. They are subsequently coupled, leaving the satin side of the two sheets on the outside. The processing is carried out exclusively on extra-clear glass so as not to alter the colour, it will result in a velvety surface to the touch.*



LACCATO satinato BIANCO



LACCATO satinato PERLA



LACCATO satinato ANTRACITE



LACCATO satinato NERO



LACCATO satinato TORTORA



LACCATO satinato SALVIA



LACCATO satinato TERRA



LACCATO satinato MELOGRANO



LACCATO satinato CIELO



LACCATO satinato LIME

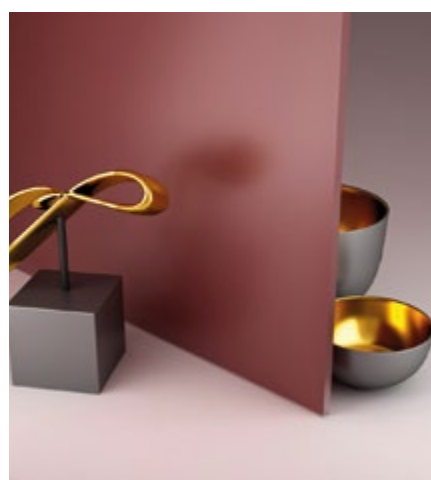

LACCATO satinato PORPORA



LACCATO satinato MALVA



# Satcolor satinati

Il vetro utilizzato è uno stratificato 5+5 mm e permette di avere una lastra colorata senza perdere l'effetto di trasparenza e di luce. La colorazione è effettuata sulla superficie satinata interna della lastra, in questo modo sarà possibile pulire l'anta senza andare a intaccare il decoro, che rimarrà inalterato nel tempo.

*The glass used is a 5+5 mm laminate and allows you to have a colored sheet without losing the effect of transparency and light. The coloring is carried out on the internal satin surface of the slab, in this way it will be possible to clean the door without damaging the decoration, which will remain unchanged over time.*



**SATCOLOR** trasparente  
BIANCO

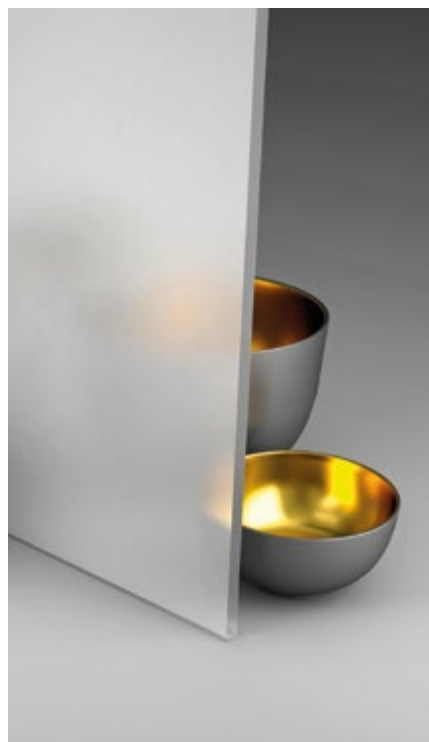

**SATCOLOR** trasparente  
PERLA / ARIAN / MOON

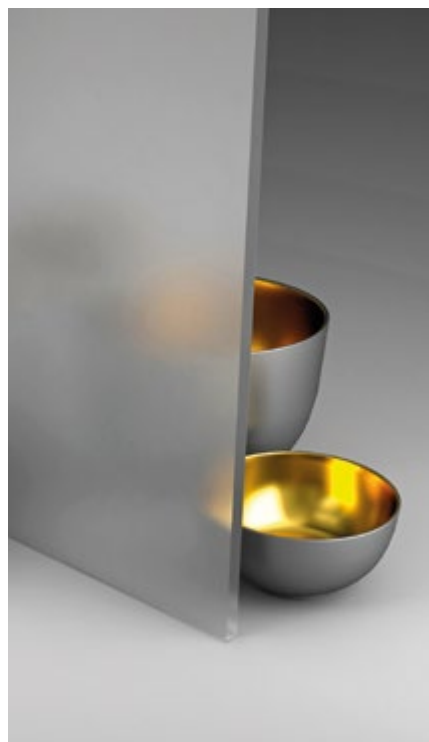

**SATCOLOR** trasparente  
TORTORA / SOHARA / LIGHT GREY

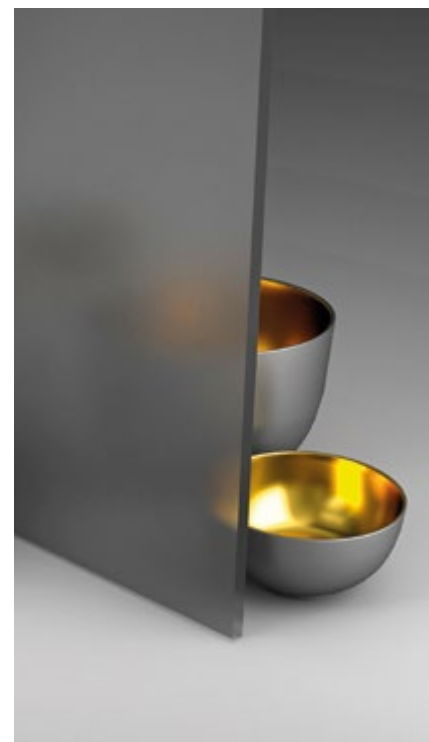

**SATCOLOR** trasparente  
ANTRACITE

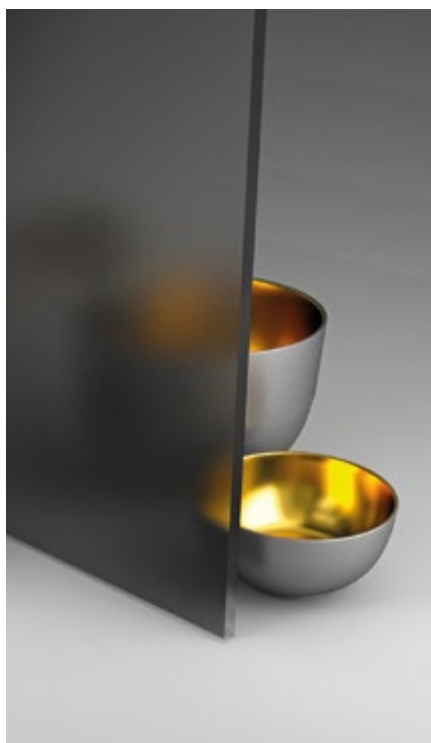

**SATCOLOR** trasparente  
NERO

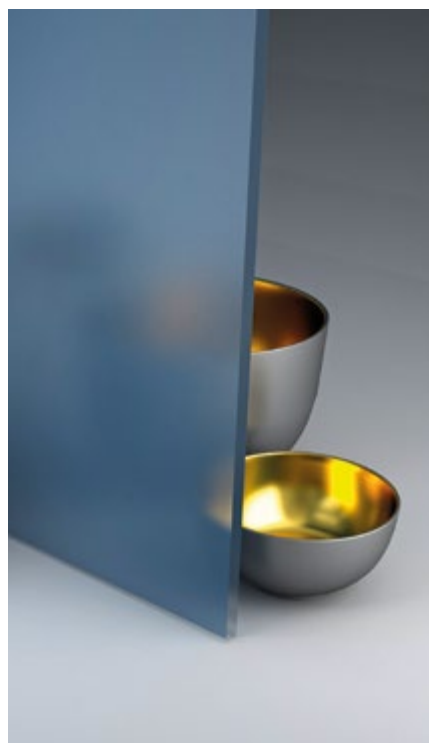

**SATCOLOR** trasparente  
CIELO / SAMOA

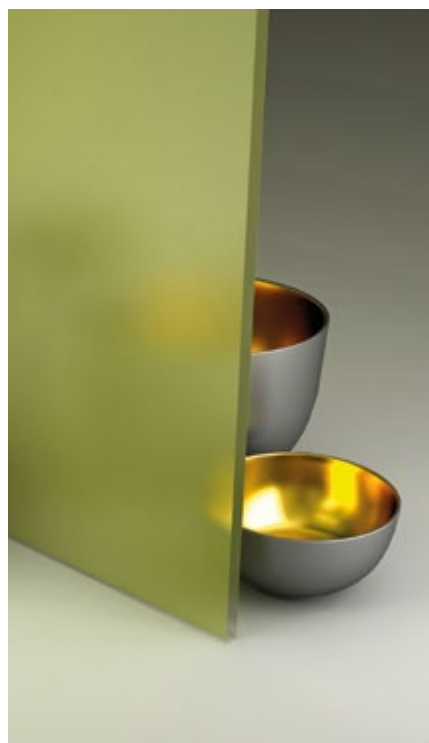

**SATCOLOR** trasparente  
LIME

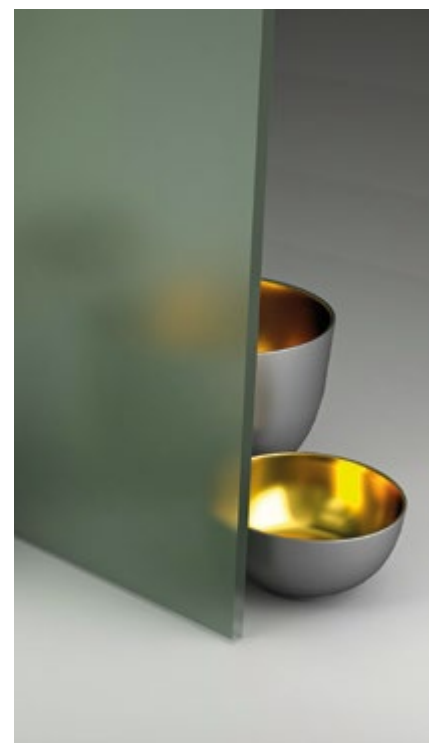

**SATCOLOR** trasparente  
SALVIA

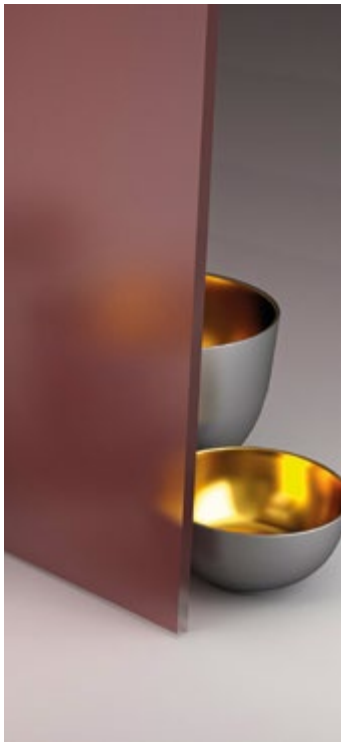

**SATCOLOR** trasparente  
PORPORA



**SATCOLOR** trasparente  
DENEBO

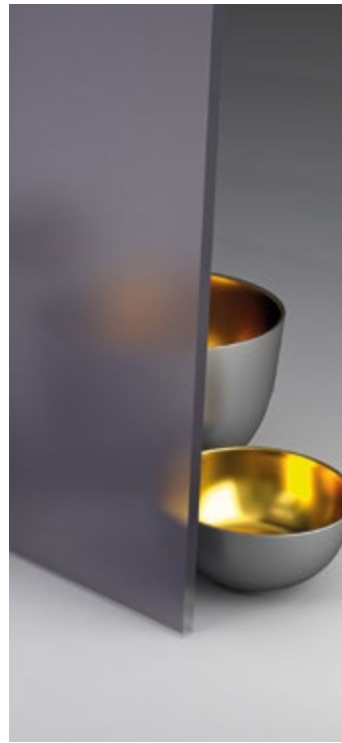

**SATCOLOR** trasparente  
MALVA

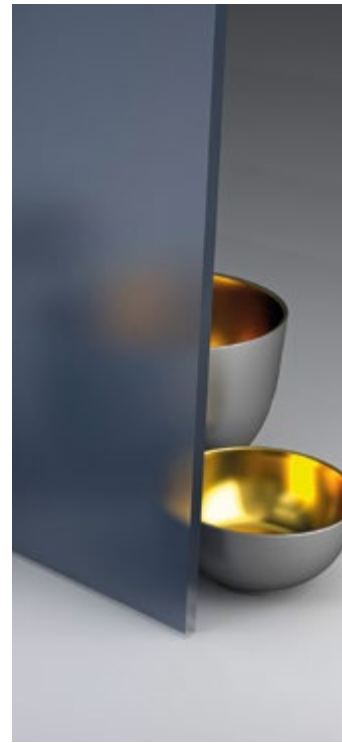

**SATCOLOR** trasparente  
STONE / BLUE MARINE



**SATCOLOR** trasparente  
GOLD

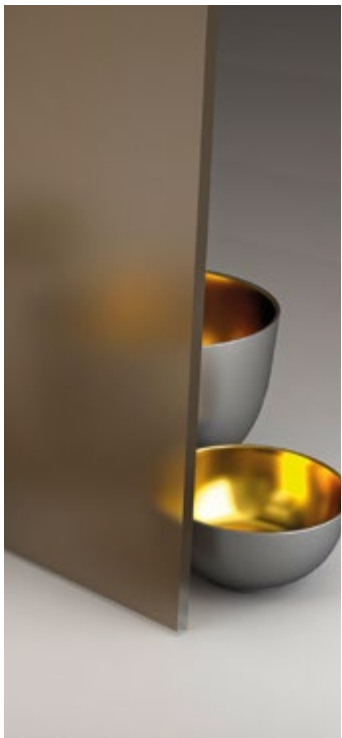

**SATCOLOR** trasparente  
ANTIQU BRASS

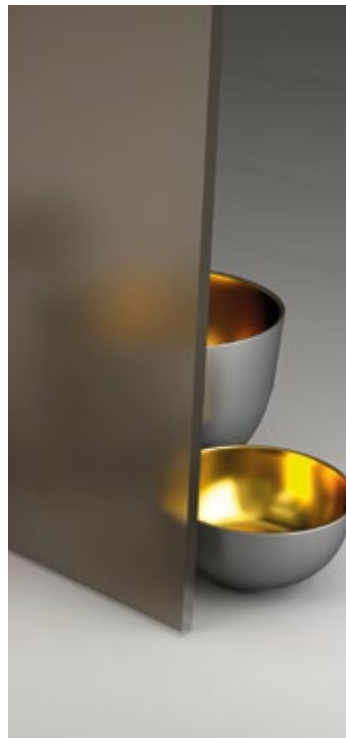

**SATCOLOR** trasparente  
DARK BRONZE

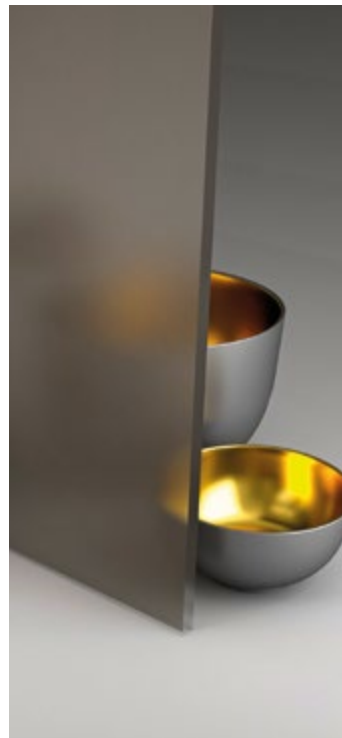

**SATCOLOR** trasparente  
AKENAR

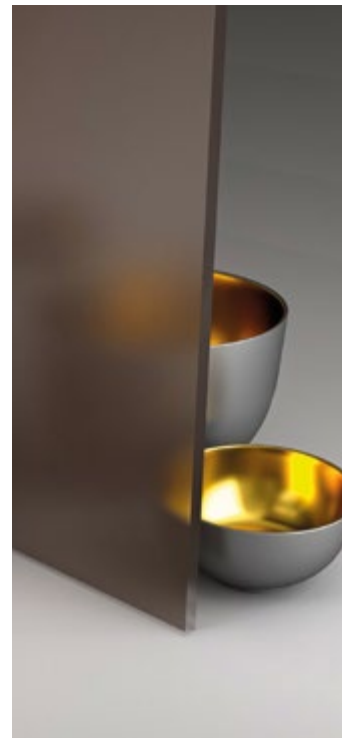

**SATCOLOR** trasparente  
TERRA / DOON

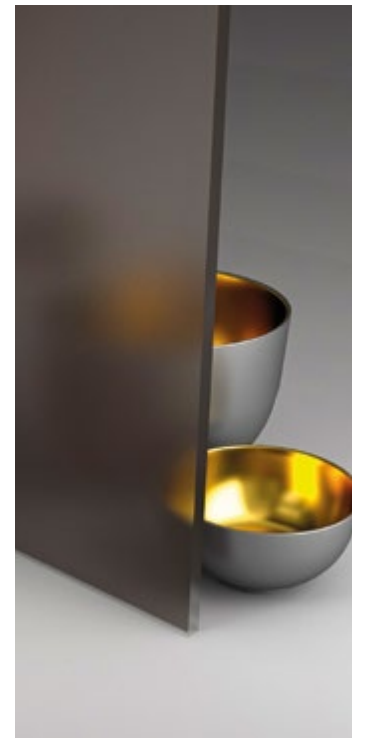

**SATCOLOR** trasparente  
BROWN



# PROFILI anodizzati Spazzolati

Sezione dedicata alle finiture disponibili dei profili in alluminio. Quattro le finiture nella versione spazzolata: lucentezza e riflessi striati le loro caratteristiche principali.

*Section dedicated to the available finishes of the aluminum profiles. There are four finishes in the brushed version: shine and streaked reflections are their main characteristics.*



**PROFILO spazzolato**  
ALLUMINIO

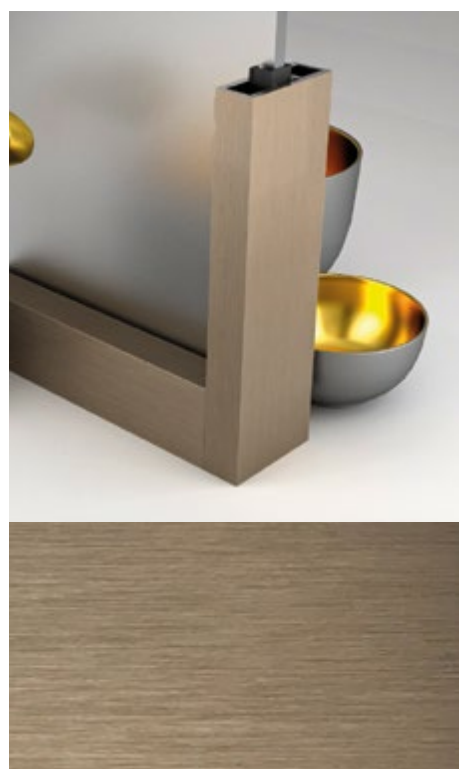

**PROFILO spazzolato**  
BRONZO



**PROFILO spazzolato**  
GRAFITE



**PROFILO spazzolato**  
BLACK

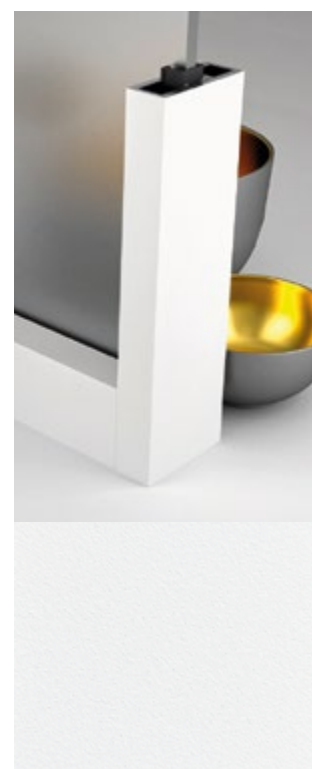

**PROFILO verniciato**  
WHITE BAY

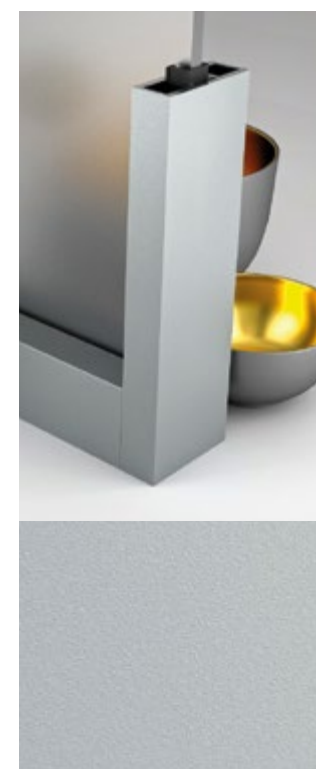

**PROFILO verniciato**  
ARIAN

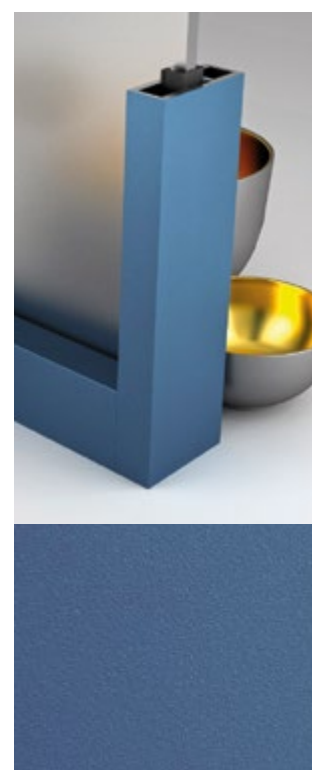

**PROFILO verniciato**  
SAMOA

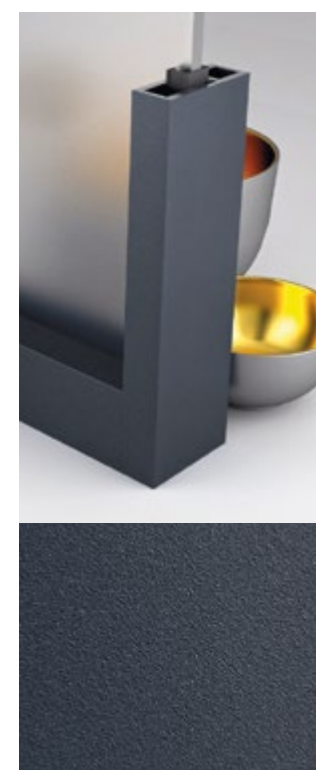

**PROFILO verniciato**  
BLUE MARINE

# PROFILI Verniciati

16 le tonalità disponibili nella versione verniciata dei profili: colori di tendenza abbinabili ad un vetro dello stesso colore per un ambiente elegante e raffinato.

16 shades available in the painted version of the profiles: trendy colors that can be combined with glass of the same color for an elegant and refined environment.



**PROFILO verniciato**  
MOON

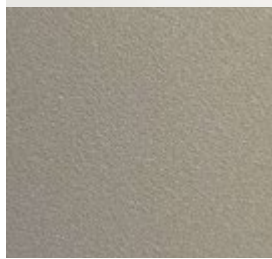

**PROFILO verniciato**  
SOHARA



**PROFILO verniciato**  
LIGHT GREY

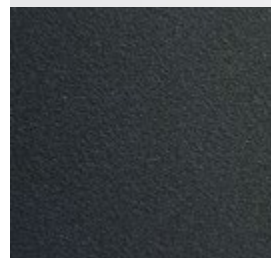

**PROFILO verniciato**  
STONE

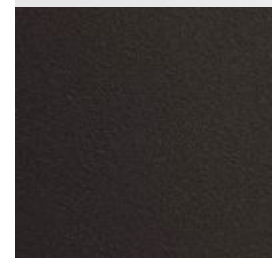

**PROFILO verniciato**  
BLANE

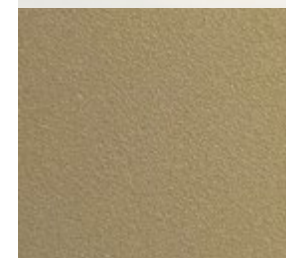
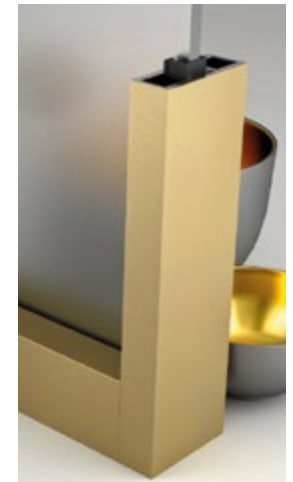

**PROFILO verniciato**  
GOLD

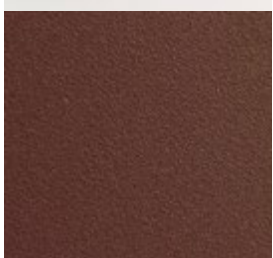

**PROFILO verniciato**  
DENEH

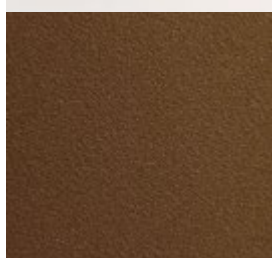
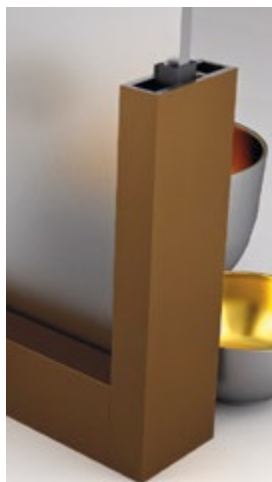

**PROFILO verniciato**  
ANTIQUE BRASS

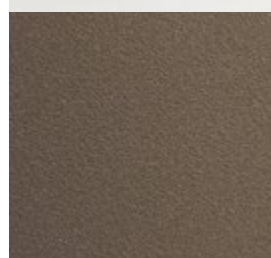

**PROFILO verniciato**  
AKENAR

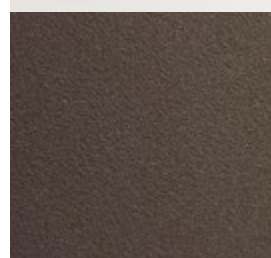

**PROFILO verniciato**  
DARK BRONZE

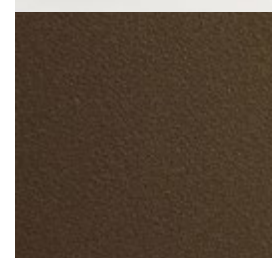

**PROFILO verniciato**  
DONN

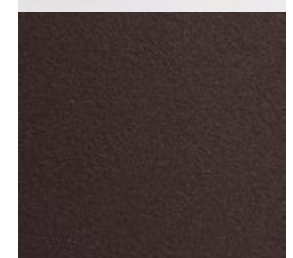
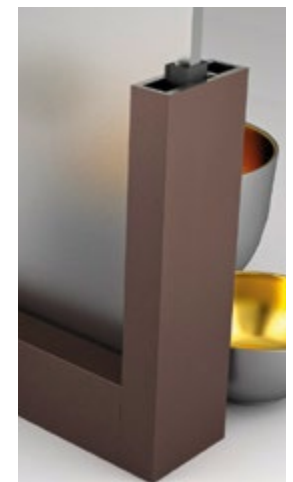

**PROFILO verniciato**  
BROWN





# SERRATURE, MANIGLIERIA E ACCESSORI

Porte in vetro perfette.  
Trova l'accessorio ideale  
per la tua porta in vetro.  
Dalle cerniere alle maniglie,  
trasforma la tua esperienza di apertura.

*Perfect Glass Doors. Find the ideal accessory  
for your glass door. From hinges to handles,  
transform your opening experience.*



# FINITURE DISPONIBILI

AVAILABLE FINISHES

Tutt'altro che optional!  
Maniglie, serrature e cerniere sono punti nevralgici delle porte "Visioni". Funzionali, robusti ed esteticamente essenziali gli accessori che compongono le nostre realizzazioni sono quel valore aggiunto che rende ogni apertura in vetro un inno alla condivisione e un invito al dialogo.

*Anything but optional! Handles, locks and hinges are basic items of 'Vision doors'. The accessories of our creations are functional, strong and aesthetically essential. They are the hallmarks that make every glass opening an ode to sharing and a suggestion to the dialogue.*



**ANN**

ALLUMINIO  
ANODIZZATO



**IS**

INOX  
SATINATO



**GBK**

ALLUMINIO  
ANODIZ. NERO



**VBI**

VERNICIATO  
BIANCO



**GGR**

ALLUMINIO  
ANODIZ. GRAFITE



**VN**

VERNICIATO  
NERO



**GBR**

ALLUMINIO  
ANODIZ. BRONZO



**VS**

VERNICIATO  
COL. SPECIALI

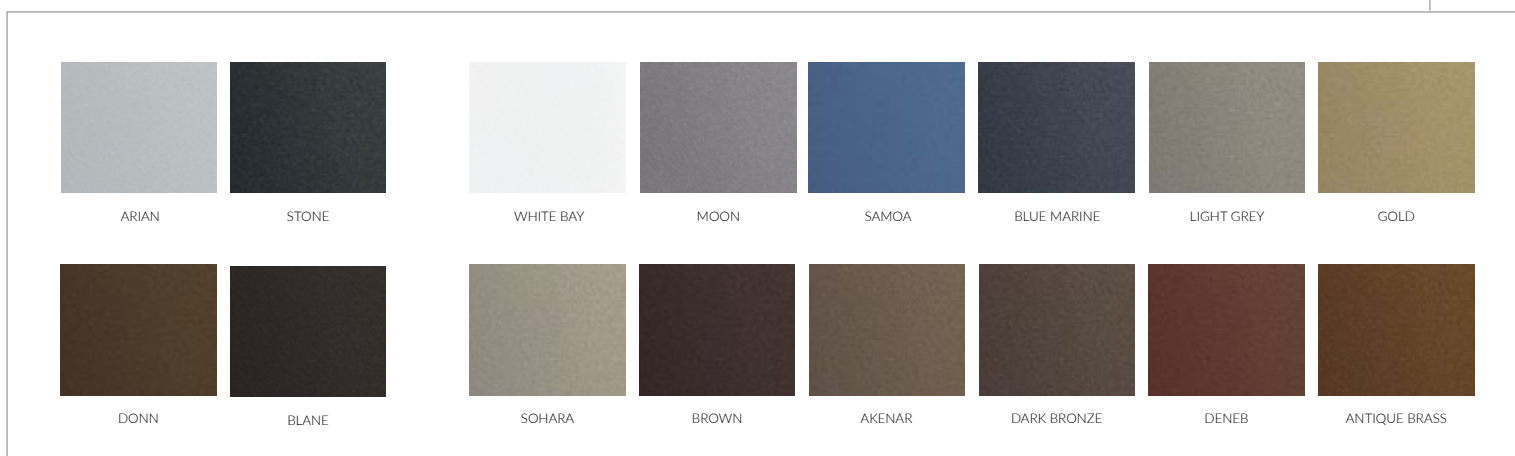

Maniglia per scorrevoli (di serie)  
*Sliding handle (standard)*

**MAN-PR28**  
h 280 mm

**ANN**  
ALLUMINIO ANODIZZATO

**GBK**  
ALLUMINIO ANODIZZ. NERO

**GGR**  
ALLUMINIO ANODIZZ. GRAFITE

**GBR**  
ALLUMINIO ANODIZZ. BRONZO

**VBI**  
VERNICIATO BIANCO

**VS**  
VERNICIATO COL. SPECIALI



Maniglia per scorrevoli e a battente  
*Sliding handle (standard)*

**SV-M**  
h 280 mm

**ANN**  
ALLUMINIO ANODIZZATO

**GBK**  
ALLUMINIO ANODIZZ. NERO

**GGR**  
ALLUMINIO ANODIZZ. GRAFITE

**GBR**  
ALLUMINIO ANODIZZ. BRONZO

**VBI**  
VERNICIATO BIANCO

**VS**  
VERNICIATO COL. SPECIALI



Maniglia per porte a battente (di serie)  
*Swing door handle (standard)*



**SM**  
h 60 mm

**ANN**  
ALLUMINIO ANODIZZATO

**GBR**  
ALLUMINIO ANODIZZ. BRONZO

**VBI**  
VERNICIATO BIANCO

**GBK**  
ALLUMINIO ANODIZZ. NERO

**GGR**  
ALLUMINIO ANODIZZ. GRAFITE

**VS**  
VERNICIATO COL. SPECIALI

Serratura orizzontale per porte a battente  
*Horizontal lock for swing doors*

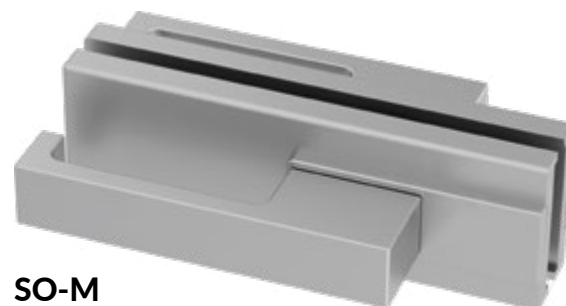

**SO-M**  
b 180 mm x h 60 mm

Serratura per porte scorrevoli e a battente  
*Lock for sliding and swing doors*

**SV-LO**  
h 280 mm

**ANN**  
ALLUMINIO ANODIZZATO

**GBK**  
ALLUMINIO ANODIZZ. NERO

**GGR**  
ALLUMINIO ANODIZZ. GRAFITE

**GBR**  
ALLUMINIO ANODIZZ. BRONZO

**VBI**  
VERNICIATO BIANCO

**VS**  
VERNICIATO COL. SPECIALI



**SV-CH**  
h 280 mm

**ANN**  
ALLUMINIO ANODIZZATO

**GBK**  
ALLUMINIO ANODIZZ. NERO

**GGR**  
ALLUMINIO ANODIZZ. GRAFITE

**GBR**  
ALLUMINIO ANODIZZ. BRONZO

**VBI**  
VERNICIATO BIANCO

**VS**  
VERNICIATO COL. SPECIALI



**SO-CH**  
b 180 mm x h 60 mm



**SO-LO**  
b 180 mm x h 60 mm

**ANN**  
ALLUMINIO ANODIZZATO

**GGR**  
ALLUMINIO ANODIZZ. GRAFITE

**GBK**  
ALLUMINIO ANODIZZ. NERO

**GBR**  
ALLUMINIO ANODIZZ. BRONZO

**VBI**  
VERNICIATO BIANCO

**VS**  
VERNICIATO COL. SPECIALI



Serratura per porta a battente **Athena**  
Athena swing door lock



**SER-ATM**



**SER-ATC**



**SER-ATN**



Cerniera per porte **Athena**  
Hinge Athena version



**CV-AT**



Serratura per porta a battente **Style**  
Style swing door lock

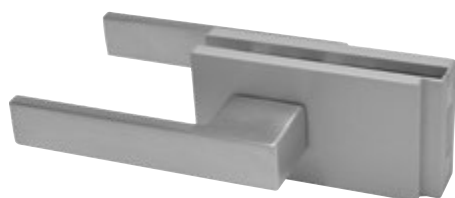

**SER-M**

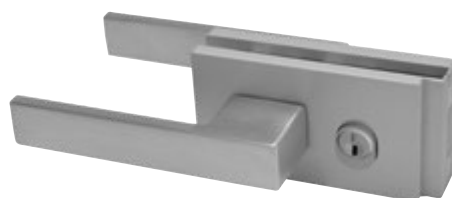

**SER-MC**

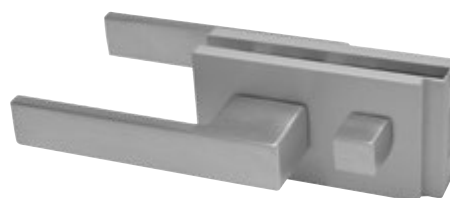

**SER-MN**



Cerniera per porte **Style**  
Hinge Style version



**CV-SB**



Serratura per porte scorrevoli  
Sliding door lock



**GSC**



**GSY**



**GSN**



Serratura magnetica a filo  
per porta a battente **Style**  
Style magnetic wire lock for swing doors



**MVS**



Cerniere per porte a ventola **Harys**  
Swing door hinges



**CV-CS**

Cerniera meccanica  
versione **EVO**  
Mechanic hinge EVO version



**CV-CO**

Cerniera oleodinamica  
versione **EVO1**  
Hydraulic hinge EVO1 version



Cerniere per porte a bilico pivot **Nemesi**  
Pivot pivot door hinges

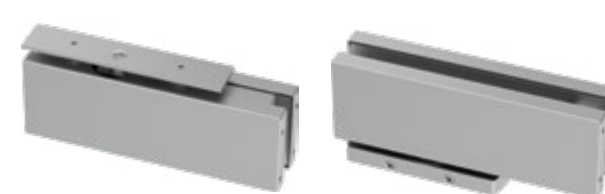

**CO-PS**

Cerniera a bilico oleodinamica  
Hydraulic hinge pivot



**VAS-T**  
Vaschetta tonda ø 60 mm  
Round handle ø 60 mm



**VAS-Q**  
Vaschetta quadra h 52 mm  
Square handle h 52 mm



**VAS-TS**  
Vaschetta tonda ø 50 mm  
Round handle ø 50 mm



**VAS-QS**  
Vaschetta quadra h 50 mm  
Square handle h 50 mm



**POM-T**  
Pomolo tondo ø 25 mm  
Round knob ø 25 mm



**POM-Q**  
Pomolo quadro h 25 mm  
Square knob h 25 mm



Serratura magnetica a filo  
per porta scorrevole  
Magnetic wire lock for sliding door



**MGS**

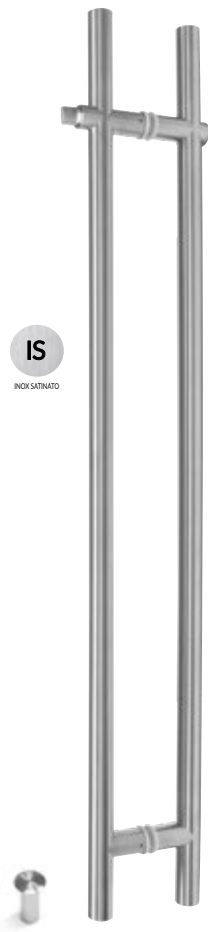

**MAN-TK**  
h 1250 mm

Maniglione tondo con chiave  
Round handle with key



**MAN-QS**  
h 470 mm

Maniglione quadro  
sagomato  
Shaped square handle



**MAN-T46**  
h 460 mm

**MAN-T66**  
h 660 mm  
**MAN-T116**  
h 1160 mm

Maniglione tondo  
Round handle



**MAN-Q46**  
h 460 mm

**MAN-Q66**  
h 660 mm  
**MAN-Q116**  
h 1160 mm

Maniglione quadro  
Square handle



**MAN-QC**  
h 500 mm

Maniglione  
quadro curvo  
Curved square handle



**MAN-T20**  
h 260 mm  
**MAN-T30**  
h 300 mm

Maniglione tondo  
Round handle



**MAN-Q20**  
h 260 mm  
**MAN-Q30**  
h 300 mm

Maniglione quadro  
Square handle



**MAD-A30**  
Coppia maniglietta adesiva  
b 15 mm x h 300 mm  
Double adhesive handle

**MAD-AQ30**  
Coppia maniglietta adesiva  
b 90 mm x h 300 mm  
Double adhesive handle



**MAD-A15**  
Coppia maniglietta adesiva  
b 15 mm x h 150 mm  
spessore 5 mm  
Double adhesive handle

**MAD-AQ15**  
Coppia maniglietta adesiva  
b 90 mm x h 150 mm  
Double adhesive handle





**AIP** s.r.l. - Divisione VISIONI  
Via Soleabò n. 20 - 12032 BARGE (CN) IT  
Tel. +39 0175 343225 - Fax +39 0175 343503  
E-mail: info@aipporte.com

[www.visionicristaldesign.com](http://www.visionicristaldesign.com)

## Certificazioni

AIP s.r.l. progetta e realizza tutti i suoi prodotti in osservanza al sistema di gestione della qualità secondo le normative prescritte dalla UNI EN ISO 9001:2015.

AIP s.r.l. designs and manufactures all of its products in accordance with the system of quality management according to the standards prescribed by the UNI EN ISO 9001:2015.



Tutti i modelli delle porte sono frutto della creatività del centro Design della AIP.

All models of the doors are the result of the creativity of the design center of the AIP.

Le finiture ed i colori illustrati nel presente catalogo sono da considerarsi puramente indicativi; inoltre AIP s.r.l. si riserva, anche senza preavviso, di apportare ai prodotti lievi modifiche e/o migliorie tecniche ed estetiche.

The finishes and colors shown in this catalog are purely indicative; also AIP s.r.l. reserves the right, without notice, to make minor changes to the products and / or technical and aesthetic improvements.

Stampa e produzione

L'ARTISTICA Savigliano  
Via Palmiro Togliatti, 44, 12038 Savigliano (CN)

**MARZO 2024**







[www.aipporte.com](http://www.aipporte.com)  
[info@aipporte.com](mailto:info@aipporte.com)

CRISTALDESIGN  
**VISIONI** 

GRUPPO  
**AIP**  
PORTE NEL TEMPO 

AIP s.r.l. - Via Soleabò, 20 - 12032 San Martino Barge (Cn) - Italia - Tel. 0175.343225